

SAFETY

On our cover: During this safety demonstration, Scouts learn about the dangers of electricity and the hazards of an electrical arc.

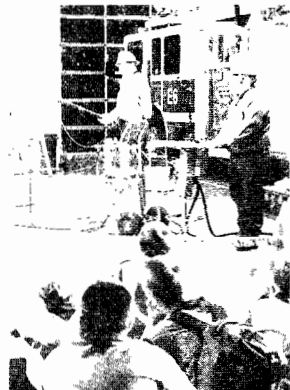

BOY SCOUTS OF AMERICA
IRVING, TEXAS

Requirements

1. Prepare a notebook to include
 - a. Newspaper and other stories, facts, and statistics showing common types and causes of injuries in the home and in the workplace, and how these injuries could be prevented
 - b. Newspaper and other stories, facts, and statistics showing common types of crimes and ways to avoid being a crime victim
 - c. Facts you have obtained concerning the frequency of accidents and of crimes in your local area
 - d. A paragraph or more, written by you, explaining how a serious fire, accident, or crime could change your family life
 - e. A list of safe practices and safety devices currently used by your family, such as safety practices used while driving or working and safety devices that prevent injuries or help in an emergency
2. Do the following:
 - a. Using a safety checklist approved by your counselor, make an inspection of your home. Explain the hazards found and how these can be corrected.
 - b. Review or develop your family's plan of escape in case of fire in your home.

3. Do the following:
 - a. Discuss with your counselor how you contribute to the safety of yourself, your family, and your community.
 - b. Show your family members how to protect themselves and your home from accidents, fire, burglary, robbery, and assault.
 - c. Discuss with your counselor the tips for online safety. Explain the steps individuals can take to help prevent identity theft.
 - d. Discuss with your counselor the three R's of Youth Protection and how to recognize child abuse.
4. Show your family the exits you would use from different public buildings (such as a theater, municipal building, library, supermarket, shopping center, or your place of worship) in the event of an emergency. Teach your family what to do in the event that they need to take shelter in or evacuate a public place.
5. Make an accident prevention plan for five family activities outside the home (at your place of worship, at a theater, on a picnic, at the beach, and while traveling, for example). Each plan should include an analysis of possible hazards, proposed action to correct hazards, and reasons for the correction you propose in each plan.
6. Plan and complete a safety project approved by your counselor for your home, school, place of worship, place of employment, or community. Include in your plan an explanation of the U.S. Department of Homeland Security's Advisory System and appropriate actions to take for each threat level.
7. Learn about three career opportunities in the field of safety. Pick one career and find out the education, training, and experience required for this profession. Discuss this choice with your counselor, and explain why this profession might interest you.



Contents

- Why Be Safe? 7
- Safety From Criminals 16
- Safety on the Road 29
- Safety in Your Home 38
- Safety Online 55
- Safety in Public Places. 59
- Safety Plans and Projects. 69
- Careers in Safety 75
- Safety Resources 78

Left: A lookout watches out for the safety of swimmers.

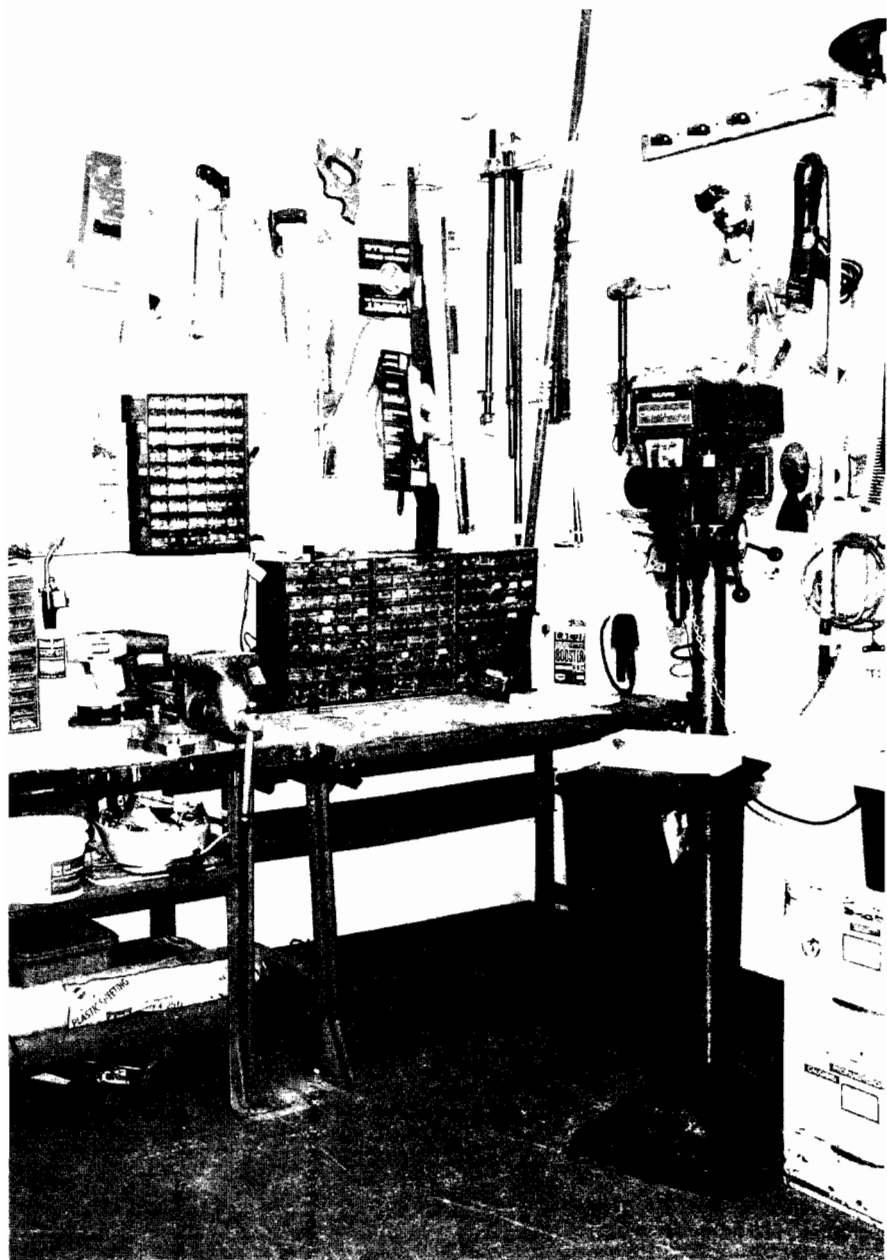

Why Be Safe?

Whatever your reasons for wanting to earn this Safety merit badge, the knowledge you gain can help you prevent accidents and respond appropriately during an emergency situation. What you learn while working on this merit badge can prepare you to make the right choices and to take the best actions so that you can help keep yourself and others safe.

This merit badge will describe common safety practices. Although it cannot cover every possible situation, this pamphlet will teach you how to help protect yourself from criminals, identify safety hazards and how to correct them, and take the best possible actions to keep yourself and others safe. Safety is part of doing your duty for your country.



When you go hiking, always tell someone where you are going and when you plan to return.

Next time you are told to be careful with electricity, remember that you are six times more likely to die from electric shock than from all the venomous snakes, hornets, and even killer bees combined.

You and Your Actions

You will find many unsafe conditions in your daily life. However, most of them become hazards only as a result of your actions when you take unnecessary risks. What might cause you to act in an unsafe way?

- Taking chances (“We were just fooling around.”)
- Being unprepared (“I didn’t think we’d need flashlights and batteries.”)
- Fatigue (“We were going to rest when we got there.”)
- Overconfidence (“I was sure I could swim a mile.”)
- Haste (“I didn’t have time to find a chopping block to cut this on.”)
- Fear (“I was so scared, I couldn’t move.”)
- Excitement (“We didn’t want to miss the kickoff, so we told Joe to step on the gas.”)
- Ignoring the rules or signs (“Sure, the sign said ‘No swimming,’ but I felt like swimming.”)
- Not using common sense (“I didn’t realize I had to know how to swim to use a canoe.”)
- The lure of the forbidden (“I didn’t know the gun was loaded.”)
- Not taking responsibility (“No one ever told me that could happen.”)



Nearly half of all accidental deaths occur in motor vehicle accidents.

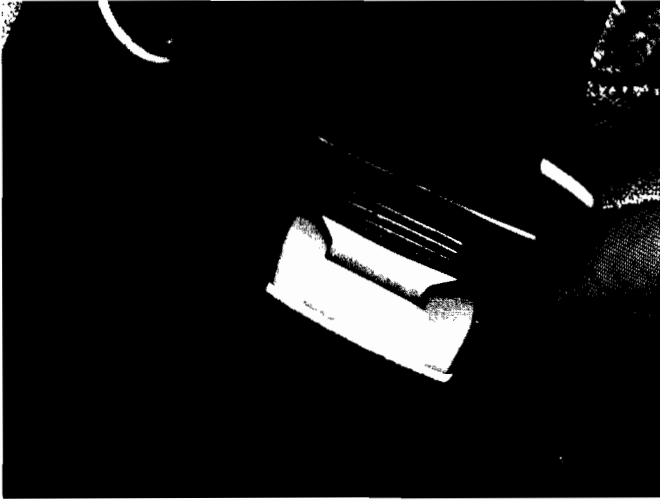

Always take a moment to consider whether your actions are safe for you and others. The time you spend is short—but it could save a life!

Accident Facts and Statistics

Do you feel safer riding in a car or flying in a plane? If you picked riding in a car, think again. Recent statistics show that passengers were 40 times more likely to die in a car crash than in a plane crash. This fact shows the importance of safety every time you ride in a car. Facts and statistics reveal potential risks and the importance of certain safety practices.

On average, there are 12 accidental deaths and about 1,000 disabling injuries every hour of every day. (A disabling injury is one that results in lost time in the victim's place of employment or that leaves the victim too injured to return to work.) About half of these deaths occur in motor vehicle accidents. More than a third of the injuries occur in the home.

Safety experts classify accidents in four broad categories: motor vehicle, work, home, and public. The public category includes accidents involving sports and recreation, swimming, and hunting. This category also includes air, water, and land transportation (such as planes, boats, and trains). It excludes motor vehicles and accidents in public buildings.

Here are statistics given by the National Safety Council for 2003. Notice the differences in the numbers of deaths and disabling injuries in the four categories.

Deaths in 2003 Due to External Causes*

From the National Safety Council

	Deaths
Motor vehicles (land)	44,800
Occupants of motor vehicles	40,000
Poisoning including drugs, alcohol, and gases	17,550
Falls	16,200
Pedestrians hit by vehicles	6,091
Suffocation—inhalation or ingested object	4,300
Motorcycles	3,215
Drownings	2,900
Fires, flames, smoke	2,600
Natural (weather-related) forces	1,219
Bicycles	767
Water travel	617
Electric shock	431
Poisonous plants and venomous animals (snakes, spiders, bees)	76

*This table is simplified for clarity. The complete table is available at <http://www.nsc.org/bst/statinfo/odds.htm>. The numbers are approximate because the figures are estimates, not the final results.

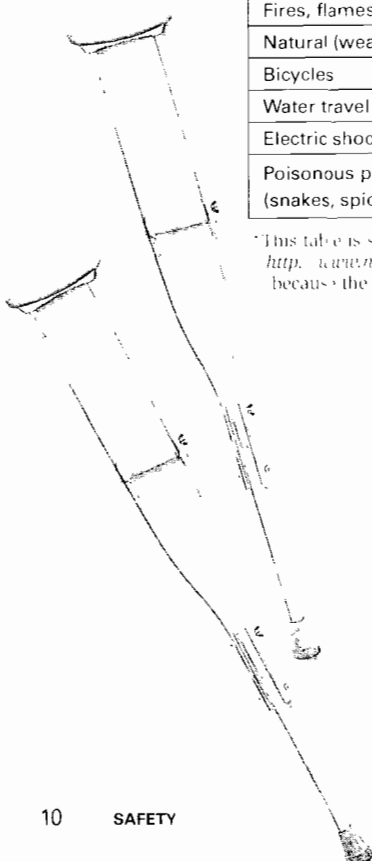

Don't Be a *DIP* (a Distracted, Inattentive Person)

Most people have laughed at the difficulty of patting their heads and rubbing their bellies at the same time. Coordination and concentration are vital to do both tasks successfully at once. Driving safely requires lots of concentration and focus. Distractions interfere with a driver's ability to notice and respond to changing situations that could lead to an accident. Driver inattention is a contributing factor in many traffic crashes. Several states have laws that prohibit careless or inattentive driving.

How do drivers get distracted? A few of the things that can break a driver's concentration include trying to catch or clean up a spill, talking with passengers, tuning the radio, shaving or applying makeup, having unrestrained animals in the car, reading a map, consulting computerized navigation systems, and using a mobile telephone. Keep these distractions to a minimum by pulling over the car any time the driver must pay attention to anything but the road.

Mobile Telephones

While there's no shortage of driver distractions that can lead to accidents, motorists using mobile telephones while they're driving have created a particularly widespread problem. The safety benefits of mobile telephones are many. Calls are often made to report a disabled vehicle, accidents, hazardous road conditions, medical emergencies, and crimes in progress. However, using the telephone while driving interferes with the coordination and concentration required for a safe trip.



**Number of Occupational Injuries and Illnesses
Involving Days Away From Work for Selected Natures, 2003**

From the Bureau of Labor Statistics

Type of Injury or Illness	Number of Injuries or Illnesses
Sprains, strains	563,910
Bruises, contusions	118,800
Cuts, lacerations	96,410
Fractures	94,960
Multiple injuries	47,950
Carpal tunnel syndrome	22,140
Heat burns	19,610
Amputations	8,150
Tendonitis	7,730
Chemical burns	7,690



As a Scout, you will most likely participate in some type of emergency preparedness drill, much like the one shown here.



Do you know someone with a broken bone? Ask the person how it happened. Ask yourself how this accident could have been prevented.

Don't Be a Statistic

It is not hard to imagine yourself becoming part of the accident statistics. Just read the daily newspaper or watch the news on TV. Not a day goes by without a story about some victim who was hurt or killed in an accident. However, learning good safety habits may help prevent an accident. Try to mix the following safety ingredients with your favorite activities.

Seek Knowledge and Skill. Know when you need to use tools or take actions to help you do an activity more safely. For instance, a beginner taking a shop class might ignore safety guards or not use a holder to safely drill a piece of wood. The novice risks losing fingers and winds up with a rejected piece of work. However, the more experienced woodworker uses safety guards and wears safety goggles to help ensure a safe experience. By following proper precautions, this woodworker turns out a perfect piece without any accidents.

Be Prepared. The safety-conscious mind thinks ahead. To have a safer and more pleasant experience, learn how to use the right tools. For a safe and enjoyable outing, plan your trip, check the weather, and go prepared.

Know and Accept Your Limitations. Learning as much as you can about an activity or sport will help you to enjoy it more safely. For example, swimmers should know and understand the hazards of swimming.

On a hike or a camping trip, which kind of Scout are you, the Scout who just picks up his pack without checking its contents or the Scout who plans and prepares?



Lifting and Carrying Heavy Objects

If not done correctly, lifting or carrying heavy boxes and other items can hurt your back. Follow these safety steps to help keep your back healthy.

- Make sure your footing is solid. Stand so that the object is close to you.
- Keep your back straight.
- Pull in your stomach and lift by straightening your legs. Lift using your strong leg muscles—not your weak back muscles.
- Get help if the object is too heavy or bulky. Do not try to carry anything that is too heavy for you.



Learning how drugs can affect you may help prevent accidents. Of course, do not take illegal drugs in the first place. Also, avoid people who do drugs, because they can be violent and are unsafe drivers.

Newspaper Stories

As you collect clippings about **accidents** in the home and workplace, look for stories that give you clues about unsafe conditions or acts that caused these accidents. Doing so will help you determine how these accidents could have been prevented.

Similarly, as you look for information about **crimes** in your neighborhood, try to find out what made the crimes possible. Were windows left open? Could deadbolt locks on doors have prevented burglaries?

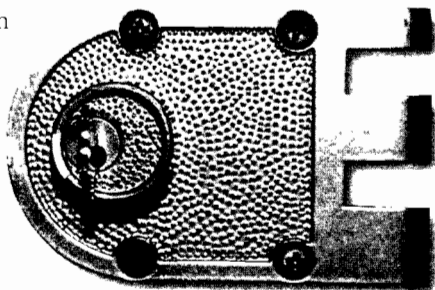

Safety From Criminals

Studies have shown that most burglars will attempt entry for only two minutes. Burglars fear being seen entering a home, so lighting, visibility, and slowing their entry will discourage them.

Years ago, many people left their homes unlocked, day and night. Today, we not only lock all doors and windows in our homes, but some also install alarm systems for added security.

Millions of burglaries and other crimes are reported to law enforcement officers every year. What can you do to help keep yourself and your family safe from criminals? One important step that you and your parents can take to help protect your home is to conduct the following home security survey.



To help protect your family and prevent a criminal from kicking in or prying open the door, install 3-inch screws in the exterior door strike plates.

Survey Your Home

Encourage your parents or guardians to take this Home Security Survey Quiz with you. If you can answer “yes” to a question, give yourself 1 point. Every checkmark in the “no” column shows a weak point that could help a burglar. By eliminating “no” checks, you improve your home and personal security.

Home Security Survey Quiz

	Yes	No
1. Do you keep a list of all valuable property? Is this list made in duplicate, with at least one copy kept in a place outside your home? <i>(In case of fire or burglary, the list will provide information necessary for insurance claims and police reports.)</i>	<input type="checkbox"/>	<input type="checkbox"/>
2. Do you have a list of credit card numbers and the serial numbers of your valuable property (cameras, computers, TVs, stereo equipment)? Is the list in a secure location?	<input type="checkbox"/>	<input type="checkbox"/>
3. Do you have a description and a photograph of all valuables that do not have an identifying number? Is this list kept in a safe deposit box?	<input type="checkbox"/>	<input type="checkbox"/>

It is important to have your parent’s or guardian’s driver’s license number engraved on valuable property that might be stolen. Numbers can be engraved onto metal objects or marked with permanent markers on other materials. Many police departments and sheriff’s offices have engraving pens available for you to borrow.

4. Do you avoid unnecessary displays of, or publicity about, your valuables? <i>(For example, a newspaper story about your valuable coin collection could also catch a thief’s eye.)</i>	<input type="checkbox"/>	<input type="checkbox"/>
5. Do you keep excess cash and other valuables in a bank? <i>(Renting a safe deposit box is a small investment compared with the potential loss from theft or fire.)</i>	<input type="checkbox"/>	<input type="checkbox"/>
6. Do you have a security closet with a solid core door, pinned or nonremovable hinges, and a deadbolt lock? <i>(Use a security closet to store things of value.)</i>	<input type="checkbox"/>	<input type="checkbox"/>

- | Yes | No | |
|--------------------------|--------------------------|--|
| <input type="checkbox"/> | <input type="checkbox"/> | 7. Do you plan so that you do not need to hide a house key under the doormat or in a similar location? <i>(It is safer to leave your house key with a close friend or reliable neighbor so that a burglar nosing around will not find it.)</i> |
| <input type="checkbox"/> | <input type="checkbox"/> | 8. Do your family members know what to do if they discover a burglar breaking in or already in your house? <i>(If you return to your home and find signs that it has been entered, do not go inside. Phone the police or sheriff from a neighbor's home. If you enter your home and find a burglar inside, expect the intruder to be frightened—and dangerous. Never struggle with a burglar unless you are in danger of serious physical harm and you are forced to defend yourself. Scream and kick—use your hands, feet, and teeth to fight off your attacker. Target painful points, including eyes, throat, temple, nose, chin, groin, knees, shins, and insteps. Make a weapon of keys, pens, pencils, or anything sharp.)</i> |
| <input type="checkbox"/> | <input type="checkbox"/> | 9. If they discover that a burglary has been committed, do family members know to leave everything undisturbed and call the sheriff or police? <i>(It is important that evidence not be moved or otherwise disturbed until police have checked it.)</i> |
| <input type="checkbox"/> | <input type="checkbox"/> | 10. Are your trees and shrubs trimmed to eliminate hiding places? <i>(Remember that shrubbery that provides privacy also gives a burglar a place to hide.)</i> |
| <input type="checkbox"/> | <input type="checkbox"/> | 11. Have you made it difficult for burglars to enter an upper floor of your home by locking up ladders and eliminating trellises and drainpipes that could be used as ladders? |
| <input type="checkbox"/> | <input type="checkbox"/> | 12. Is the outside of your home well lit, including a porch light with at least a 60-watt bulb? <i>(Light yards, windows, and each exterior doorway to eliminate dark hiding places. Burn porch lights from dusk until dawn with a 60-watt bulb. Consider installing photoelectric on-off or motion-sensor devices. In rural areas that have no streetlights, electric companies often will give group discounts to customers who want to install security lighting.)</i> |
| <input type="checkbox"/> | <input type="checkbox"/> | 13. Is your house number easily visible from the street at any hour? <i>(Drivers of emergency vehicles prefer numbers painted on the curb.)</i> |

- | | Yes | No |
|---|--------------------------|--------------------------|
| 14. Do you have emergency telephone numbers listed on every phone? <i>(In most areas of the country, the 911 phone number will connect you with emergency services. Often, a computer immediately displays your address to the dispatcher who answers your call.)</i> | <input type="checkbox"/> | <input type="checkbox"/> |
| 15. Do you use good telephone security procedures? <i>(Never give personal information such as your name, age, or address to a stranger over the telephone. Never let strangers on the phone know when you will or will not be home. Never tell a stranger on the phone that you are home alone. Instead, tell the caller, "My mom can't come to the phone right now. May I take a message?")</i> | <input type="checkbox"/> | <input type="checkbox"/> |



Be sure you have a plan to help ensure your family has telephone access in case the electricity goes out or if the phone lines go down.

At night, light entryways to discourage burglars from hiding there.

Doors and Entry Areas

- | | | |
|---|--------------------------|--------------------------|
| 16. Are your exterior doors made of solid-core construction? <i>(A hollow-core door is fragile. Two blows with a hammer and a burglar could break through a hollow door, reach in, and unlock the door from inside. Replace hollow-core exterior doors with solid doors whenever possible.)</i> | <input type="checkbox"/> | <input type="checkbox"/> |
| 17. Do your entry doors have wide-angle viewers called peepholes? <i>(A peephole lets you see the visitor before deciding whether to open the door.)</i> | <input type="checkbox"/> | <input type="checkbox"/> |

Home Security Devices

Hardware on these home security devices should be accessible from inside the house only.

Thumb-turn deadlock

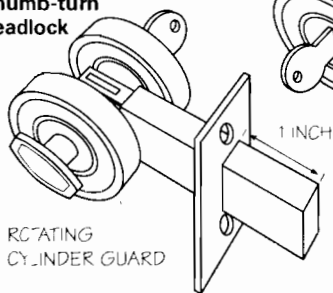

Double cylinder deadlock

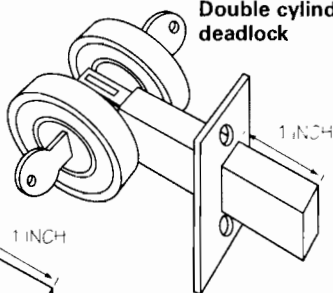

Pinned hinge

DRILL A 1/4-INCH-DEEP HOLE THROUGH THE OPENING IN THE OPPOSITE HINGE PLATE ON THE DOOR. AS THE DOOR CLOSES, THE PIN IN THE JAMB WILL ENTER THE HOLE IN THE DOOR AND HOLD THE DOOR IN POSITION EVEN IF THE HINGE PINS ARE REMOVED.

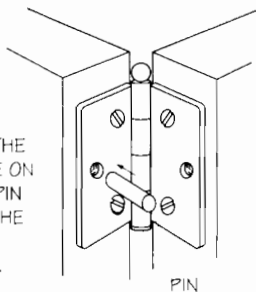

Sliding-door stop

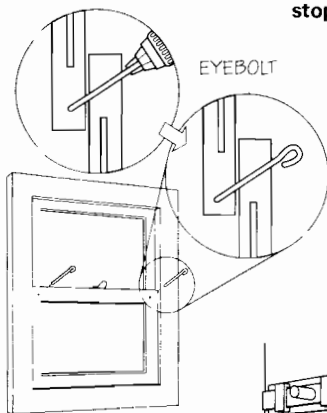

Pinned window

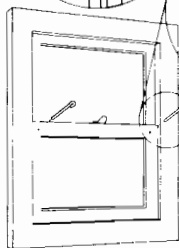

Heavy bolt

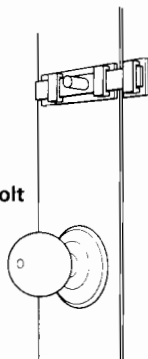

- | | Yes | No |
|---|--------------------------|--------------------------|
| 18. Are the locks on your doors secure from being opened if a burglar breaks out a pane of glass or a panel of lightweight wood? <i>(This situation calls for a lock that can be opened only from the inside with a key. Some communities do not permit this type of lock because it can prevent escape from a fire if the key is not in place. If you use this type of lock, be sure to leave the key in the lock when anyone is at home. Remove the key only when the home is empty.)</i> | <input type="checkbox"/> | <input type="checkbox"/> |
| 19. Do exterior doors have cylinder-type deadbolt locks with at least a 1-inch throw and a beveled cylinder guard? | <input type="checkbox"/> | <input type="checkbox"/> |
| 20. Do doors without cylinder locks have a heavy bolt or some similar security device that can be operated from the inside only? | <input type="checkbox"/> | <input type="checkbox"/> |
| 21. Can all of your doors (basement, porch, sliding, French, balcony) be securely locked? | <input type="checkbox"/> | <input type="checkbox"/> |
| 22. Do your basement doors have locks that allow you to isolate that part of your home? <i>(Basement windows are among the easiest for a burglar to enter undetected. If your basement is securely locked from the rest of your home, a burglar's activities might remain limited to that area.)</i> | <input type="checkbox"/> | <input type="checkbox"/> |
| 23. Are all of your locks in good repair? | <input type="checkbox"/> | <input type="checkbox"/> |
| 24. Are door strike plates installed with 3-inch screws? <i>(Three-inch screws will reach the stud inside the wall.)</i> | <input type="checkbox"/> | <input type="checkbox"/> |
| 25. Do you know everyone who has a key to your home? <i>(Do not carry house keys on the same ring as car keys. It is very easy to leave the keys together when the car is in a garage for repairs or left in a commercial parking lot where an attendant parks cars. Anyone who handles your house keys can easily have duplicates made.)</i> | <input type="checkbox"/> | <input type="checkbox"/> |
| 26. Do all out-swinging doors in your home have the hinges pinned or have nonremovable pins? <i>(If they do not have nonremovable pins, you can easily pin a door so that it cannot be opened even if the hinge pins are removed. See the illustration of the pinned hinge.)</i> | <input type="checkbox"/> | <input type="checkbox"/> |
| 27. Are entry areas free of shrubbery and decorations that limit visibility? | <input type="checkbox"/> | <input type="checkbox"/> |
| 28. Do sliding doors have a lock that locks both the door panels together or locks the active side to the frame? <i>(You can place a wooden dowel or broomstick in the floor track to prevent a sliding door from opening.)</i> | <input type="checkbox"/> | <input type="checkbox"/> |

- | Yes | No | |
|--------------------------|--------------------------|---|
| <input type="checkbox"/> | <input type="checkbox"/> | 29. Is the garage door secured with a padlock, hasp, or other good lock? <i>(Even garage doors with electric openers need separate locks. In a double-car garage with a single long door, it is important to place a lock on each side of the door to keep a burglar from pulling out one side and crawling through.)</i> |
| <input type="checkbox"/> | <input type="checkbox"/> | 30. Do you lock your garage door and the door between your house and garage at night? Do all family members know how to unlock these doors in case of emergency? |
| <input type="checkbox"/> | <input type="checkbox"/> | 31. Do you lock your garage door and the door between your house and garage when you leave home? |
| <input type="checkbox"/> | <input type="checkbox"/> | 32. Do you lock your car and remove the keys even when it is parked in your garage? |

Burglar or Robber? A robbery is when the thief attacks someone face-to-face, such as stealing a person's wallet. A burglary is when a thief breaks into a building or home to commit a crime.

- | Yes | No | Windows |
|--------------------------|--------------------------|--|
| <input type="checkbox"/> | <input type="checkbox"/> | 33. Are all windows in your home equipped with key locks or pinned? <i>(You can secure a sliding window with a rod in the same way as a sliding door.)</i> |
| <input type="checkbox"/> | <input type="checkbox"/> | 34. Are window locks properly and securely mounted? |
| <input type="checkbox"/> | <input type="checkbox"/> | 35. Do you keep your windows locked when they are shut? |
| <input type="checkbox"/> | <input type="checkbox"/> | 36. Do you use locks that let you lock a window left partly open? |
| <input type="checkbox"/> | <input type="checkbox"/> | 37. Have you replaced or secured louvered windows? <i>(Consider replacing louvered windows; burglars find them easy to enter. If you cannot replace a louvered window, use epoxy glue to secure the louver to its frame.)</i> |
| <input type="checkbox"/> | <input type="checkbox"/> | 38. If you live in an area with a high burglary rate, do you use window bars or ornamental grilles? <i>(Take care that bars or grilles do not create an escape hazard in the event of a fire. They must have an inside quick-release mechanism that allows those inside to swing the grilles out in an emergency.)</i> |
| <input type="checkbox"/> | <input type="checkbox"/> | 39. Do you have secure locks on garage windows? |
| <input type="checkbox"/> | <input type="checkbox"/> | 40. Do you cover garage windows with curtains? <i>(Curtains on garage windows keep burglars from "window shopping" the items in your garage.)</i> |
| <input type="checkbox"/> | <input type="checkbox"/> | 41. Are you as careful to secure basement and second-story windows as you are to secure windows on the first floor? |



When you go on a trip, ask a friend or neighbor to keep an eye on your home.

Going Out of Town

- | | Yes | No |
|---|--------------------------|--------------------------|
| 42. Do you arrange for friends or neighbors to pick up newspapers, mail, and other deliveries each day? | <input type="checkbox"/> | <input type="checkbox"/> |
| 43. Do you notify a neighbor that you will be gone? <i>(Leave a key with a friend or neighbor, and ask that your home be checked every so often.)</i> | <input type="checkbox"/> | <input type="checkbox"/> |
| 44. Do you notify your police or sheriff that you will be gone? | <input type="checkbox"/> | <input type="checkbox"/> |
| 45. Do you arrange to make your home look lived-in while you are away? <i>(Leave some window shades up or curtains open so that your home does not look deserted. Have someone periodically open and close drapes and turn different lights on and off, or use timers to operate lights, so that the house appears occupied. Consider asking friends or relatives to live in your home while you are away. Leave a car in the driveway or ask neighbors to park in your driveway. Ask a neighbor to put some trash in your trash cans. Arrange to keep your lawn if need be.)</i> | <input type="checkbox"/> | <input type="checkbox"/> |

Yes

No

46. When you are planning a trip, do you secure your telephone?
(Notify the telephone company at least two weeks before you leave and arrangements can be made for a recording to answer your phone each time it rings to state that your phone is temporarily out of order. Alternatively, use call forwarding if this service is available in your area.)

47. Do you store your valuables in a secure place while you are gone, such as a safe-deposit box in a bank?

Safety Away From Home

Use the following tips for staying safe and protecting your property when you are away from home:

- Never carry large amounts of cash or “flash” a wad of bills where it can be seen.
- Do not resist an armed robber. Hand over your wallet and other valuables quickly and quietly.
- Avoid dark streets. Walk with a companion whenever possible. Stay away from dark alleys, bushes, and any other place that could conceal an attacker.
- Lock all car doors and keep them locked while the vehicle is in motion.
- Lock your car every time you leave it. When you return to your car, look in, under, and around it to be sure no attacker is lying in wait.
- Store valuables in your car trunk. Valuables are less likely to be stolen when thieves cannot see them through car windows.
- Never pick up hitchhikers. You cannot tell by looking whether a person is harmless or dangerous.



If an attacker grabs your wrist, spin your arm in a circular movement toward the attacker's thumb to free yourself. Try it with a friend, and then teach it to younger children.

Take a critical look at your home security every three or four months. If you would like professional help for a home security inspection, call your local law enforcement agency.



If someone grabs you while you are riding your bike, hold onto your bike. This makes you very bulky and heavy—too heavy to drag off.

Protecting Yourself

In today's society, you need to know how to protect yourself against abuse or abduction. There are more than 3 million reports of child abuse each year.

If you have younger brothers or sisters, talk with your parents about the dangers of children talking with strangers or accepting rides from strangers. Abductors often lure children by offering candy, claiming their family has an emergency, asking for directions, or asking for help finding a pet. They sometimes even use phony police or other badges.

Three R's of Youth Protection

1. **Recognize** that anyone could be a child molester. Be aware of situations that could lead to abuse.
2. **Resist** advances made by child molesters to avoid being abused.
3. **Report** any molestation or attempted molestation to parents or other trusted adults.

What Is Child Abuse?

The first step to stopping child abuse is being able to recognize it. There are four basic kinds of abuse: physical, emotional, neglect, and sexual.

Physical child abuse is intentional injury to a child from a caregiver, guardian, parent, or other adult. Physical abuse often stems from unreasonable punishment, or from punishment that is too harsh for the child.

Emotional child abuse occurs when an adult needlessly hurts a child's self-esteem. An adult's words may correct or instruct but should never ridicule, reject, wrongly blame, or compare with siblings. This type of abuse is more difficult to recognize because the bruises are not left on the skin but on the child's ego.

Neglect happens when the person the child depends on, like a parent or guardian, deliberately (not because they are underprivileged) fails to provide for the child's basic needs. Basic needs include showing affection and providing food, clothing, shelter, medical care, education, and supervision.

Sexual child abuse is when an adult or older child, called a molester, forces or manipulates a child to be involved in a sexual activity. This can be any activity performed for the sexual pleasure of the molester, from exposing sex organs to fondling or even rape. Often the molester is someone the child knows and trusts. Molesters usually try to threaten or bribe children to keep them quiet.

If someone or some situation makes you or another child feel uncomfortable, trust your instincts. Get away from the situation and talk to your parents or another trusted adult, such as a teacher.

What Else Can You Do?

There are some precautions you can take to stay safe. First, obey laws yourself. Avoid questionable situations that might tempt you to break the law. You should also set a good example for others, especially younger siblings and friends. Cooperate fully with law enforcement officials; be willing to swear out complaints and appear as a witness. Report suspicious activities, such as an unfamiliar car driving slowly through the neighborhood. Finally, participate in a Neighborhood Watch program.

Neighborhood Watch groups are established in neighborhoods by law enforcement agencies working together with citizens. Trained police officers meet with citizens and discuss how people can protect themselves and their property from criminals. The police encourage citizens in a Neighborhood Watch program to be concerned about the safety of the entire neighborhood. They ask residents to report unusual activities and strangers in the area—strangers who might be “casing” a home (watching the home closely) before a robbery. As citizens become involved in looking out for the safety of others, their entire neighborhood becomes safer.

For more information on preventing crime and getting a Neighborhood Watch group started, see the *Crime Prevention* merit badge pamphlet.

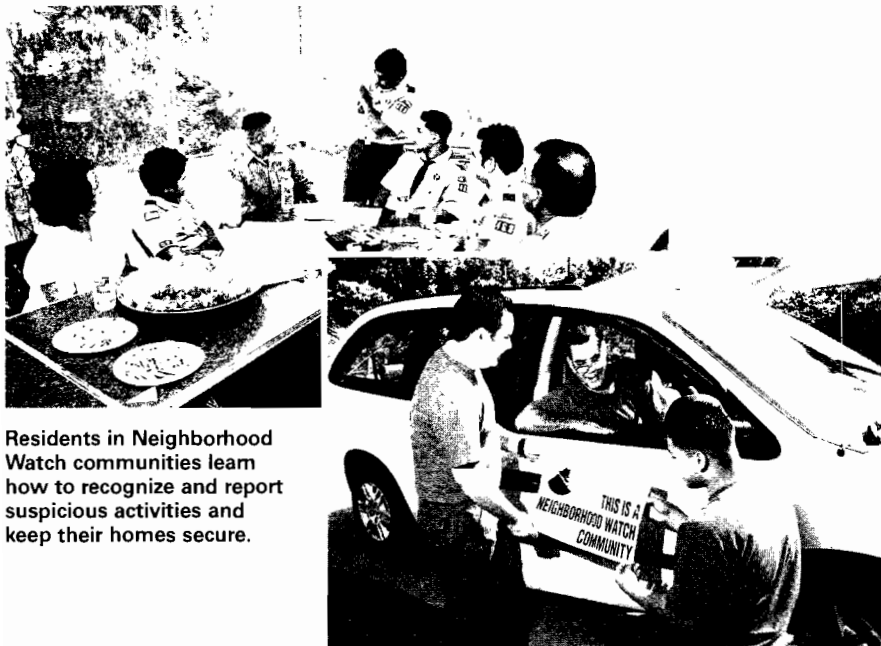

Residents in Neighborhood Watch communities learn how to recognize and report suspicious activities and keep their homes secure.



helmet while riding a bike.

Safety on the Road

Road safety is a subject big enough to fill several books. There is not room in this pamphlet for every detail that you need to know. Be sure to check other pamphlets in the merit badge series, especially *Crime Prevention*, *Cycling*, *Railroading*, and *Traffic Safety*.

Pedestrian Safety

When a pedestrian and a car have an accident, the pedestrian does not win. More than 6,000 people die in pedestrian accidents each year. Use the following pedestrian rules every time you take a walk:

- Cross streets only at intersections. Do not jaywalk.
- At intersections with traffic lights, cross only on green, or when there is a "walk" sign lighted.
- Look both ways for cars, and look around the corner before stepping off the curb.



Do not risk your life against the power, weight, and speed of a vehicle—even if you think you have the right-of-way.

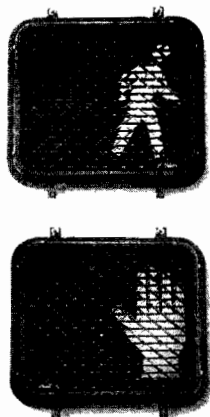

- For added protection and sure footing, walk with closed-toed shoes.
- Cross streets quickly, but do not run. Cross only at designated crosswalks.
- When you are carrying something, hold it so you can still see clearly in front of and on each side of you.
- At night, carry a light or something white. Wear light-colored or reflective clothing.
- If there are no sidewalks, walk on the left side of the street so that you face oncoming traffic. If there is no shoulder on the roadway, it may be safer to walk on the grass or find an alternate route.
- Do not play in the street.
- Stay alert. Do not walk and talk on a mobile phone at the same time. If you wear earphones, be sure you can still hear what is going on around you.

If you are afoot when a loose dog threatens you, stand still and quiet with your arms at your side, then slowly back away. Do not turn and run. If you are knocked down, curl into a ball with your arms protecting your head.

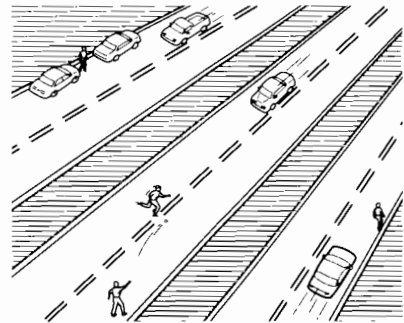
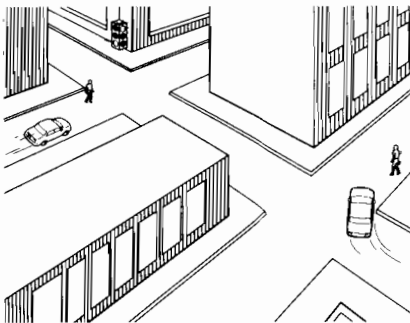

How many unsafe pedestrian acts can you see in these illustrations? How can they be corrected?

Bicycle Safety

Riding a bicycle is fun. Review and follow the Boy Scouts of America Bike Safety Guidelines to keep your peddling fun.

Bike Safety Guidelines

- **Physical Fitness.** Biking is strenuous. Long treks and hill climbing should not be attempted without training and preparation. For Scouting activities, all participants must present evidence of fitness shown by a complete health history: from a physician, parent, or legal guardian. The adult supervisor should adjust all supervision, discipline, and protection to anticipate any potential risks associated with individual health conditions.



- **Helmets and Clothing.** All cyclists must wear a properly sized and fitted helmet approved by either the Snell Memorial Foundation or the American National Standards Institute (ANSI). Layer your clothing for warmth on cool days so you can avoid chilling or overheating. Cover up for sun protection on clear days. Wear footwear that effectively covers and protects your feet.
- **Buddy Up.** When the program activity is a bicycle expedition or trek, the buddy system must be used. When there is program activity emphasizing individual performance skills, one buddy observes while the other takes a turn. In competitive activity where the buddy concept cannot be practically applied, all activity must be directly observed by the adult supervisor. (When biking, apart from Scouting activities, youth members should be encouraged to go with a buddy, and tell someone their route, schedule, and destination before departing.)

Especially if you will be riding at dawn, dusk, or in darkness, be sure you wear clothing that has reflective properties. For added visibility, affix reflective tape on your bike and helmet.

When you are out cycling, protect yourself from a territorial dog by crossing the street or even going around the block. Also stay away from dogs riding in the beds of pickup trucks.

- **Keep Right.** Ride with the traffic flow, as far to the right as possible (or at least 3 feet from traffic). Avoid curbs, tree limbs and shrubs, storm drains, soft or loose gravel on shoulders, and other hazards.
- **Be Smart.** Obey all traffic laws, signs, signals, and street markings. Watch for changes in road conditions. Ride only one (1) a bike. Do not ride after dark. No stunts—trick riding is only for professionals who use special equipment. Yield to motor vehicles even if you think you have the right-of-way. Never hitch a ride on another vehicle. Keep your eyes and ears open, and do not wear headphones while riding.
- **Turns and Intersections.** Look left, right, back, and ahead before turning. Stop and search all directions when entering a street from a driveway, a parking area, a sidewalk, or an alley. Signal all turns using universal hand signals. Walk your bike through or across busy intersections.
- **Ride the Right Bike.** Ride only a bike that fits you. Select a bike that permits you to put both feet on the ground while sitting on the seat. The handgrips should not be higher than your shoulder or lower than your seat. Adjust your seat as necessary.
- **Accessories.** Every bike needs a horn or bell and reflectors (front, back, and sides). Items should be carried only in baskets, saddlebags, or on a rear carrier rack. If you must ride in traffic, a bike- or helmet-mounted mirror is recommended. For long trips, a bike-mounted container for drinking water is a good idea.
- **Maintenance.** Keep your bike clean and well-maintained—especially the brakes, drive chain, and tires.
- **Race Right.** Street racing is dangerous. Race only with supervision on marked courses that have been set up to exclude other vehicle or pedestrian traffic, to eliminate fall hazards and minimize collision risks, and to define clear start and finish points.



- **Planning.** Plan both the route and timing of bike trips to avoid heavy traffic and hazardous conditions. Biking is unsafe on wet pavement and on windy days. Plan for at least hourly rest stops and a maximum of approximately six hours on the bike per day.
- **Discipline.** All participants should know, understand, and follow the rules and procedures for safe biking. All participants should conscientiously and carefully follow all directions from the adult supervisor.



Whenever you are traveling on a motorcycle, always wear a helmet.

Safety on Motorcycles, Scooters, Motorbikes, and Minibikes

Because they are motorized, the same laws that apply to automobiles usually cover these vehicles. There are laws about how old a driver must be, as well as insurance, licensing, and similar regulations. Be aware that there are several hazards posed by such vehicles: They are powerful in relation to their weight, the rider is exposed and has no built-in protection, and they are less stable than cars.

Always wear a safety helmet when you ride one of these vehicles. As with bicycle helmets, choose a motorcycle helmet that meets standards set by the Snell Memorial Foundation or ANSI. Motorcycle helmets save more than 1,000 lives each year.

Check with local law enforcement before you drive a motor scooter or pocket bike on any public road, even if you are a licensed driver. Because of the increased risks in operating these vehicles, they are not recommended modes of transportation for Scout-age youths.

According to the National Highway Traffic Safety Administration, driver distractions are a factor in more than 20 percent of vehicle crashes.



Always use a car seat when transporting a young child in a vehicle. Since 1975, car seats have saved the lives of more than 6,000 children.

Passenger Safety

You might think that passengers are at the mercy of the driver or operator—and in many ways, they are. But there are some important things passengers can do to keep safe. Follow these rules, because the leading killer of Scout-age boys is motor vehicle accidents.

Passenger in a Vehicle

Here are some safety tips for safe riding.

- Always use your safety belt. Talk to your family about making a family rule that the driver does not start the engine until everyone has buckled up.
- Wear your safety belt properly. Never tuck a shoulder belt behind your back or under your shoulder.
- Keep quiet and turn off the radio in a difficult traffic situation. Limit driver distractions by doing things for them like changing radio stations or using the mobile phone or navigation system.

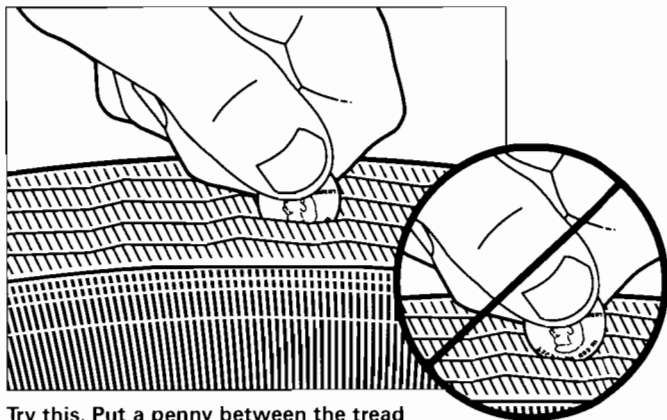

Try this. Put a penny between the tread of a vehicle's tires. If the tread does not reach beyond Lincoln's head, as in this illustration, then the tires do not meet most states' legal required minimum tread of $\frac{2}{32}$ inch. Worn tires are unable to properly grip the road.

When a news report says that a person was "ejected" from the car, it almost always means the person was not wearing a safety belt.

- Talk to the driver when he or she is tired or bored. Doing so will help keep the driver alert and awake.
- Urge the driver to stop every couple hours. Bring a bal. and play catch in a roadside park if you can. The driver needs to stretch and relieve tense muscles.
- Learn to read road maps. You can take strain off the driver by giving good directions and telling the driver where to turn well ahead of time.
- Keep younger children occupied with quiet games and activities. If necessary, ask the driver to pull over to stop quarrels.
- Lock all doors and see that hands, heads, and feet are kept inside the vehicle, even when it is parked. A locked door is less likely to spring open in a crash.

Forty percent of fatal traffic crashes are alcohol related. If your driver appears to be intoxicated, phone for another ride. Do not get in the car if the driver appears to be intoxicated.

Passenger on a Bus or Train

Follow these tips whenever you ride a bus or train.

- In case the vehicle starts or stops abruptly, use the hand-rail to keep your balance.
- Wait for the vehicle to come to a complete stop before you get on or off.
- Cross the street behind a bus, or after it leaves and you can see oncoming traffic. Do not walk in front of a bus unless it is a school bus and the driver motions you across while the bus and traffic are stopped.
- Do not talk to or otherwise disturb a bus driver. (This rule applies for school buses, too.)
- Stay in your seat while the vehicle is moving.

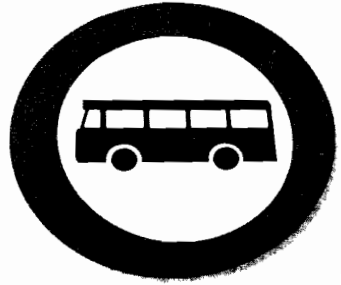

Passenger in an Airplane

Here are a few tips for airline passengers.

- Pay attention to the flight attendant's instructions about exits, oxygen masks, life preservers, and buckling up.
- Use safety seat belts.
- During takeoff and landing, stay in your seat unless the plane is stopped at the gate.
- Keep your feet and luggage out of the aisles. Store your carry-on luggage as directed.

In Case of Emergency

Many people carry mobile phones these days, but not everyone carries details of whom should be called on their behalf in case they are involved in a serious accident. If you add the acronym ICE—for “In Case of Emergency”—as a contact in your mobile phone, paramedics or other rescue workers can quickly find someone to notify about your condition. As a minor, you should choose an ICE contact—probably your parent or guardian—who can give consent for emergency medical treatment.

Fill Her Up!

The fumes from gasoline are highly flammable. Whenever you fuel a vehicle at the pumps, follow these safety guidelines:

- Put the vehicle in park, and turn off the engine.
- Put the keys in a safe place like your pocket. Keys left in the ignition are an easy theft target.
- Make sure people do not light matches, smoke, or use any other ignition source.
- To avoid spillage, use only the refueling latch on the dispenser. If there is none, do not jam something like a gas cap under the refueling latch because it cannot automatically release when the tank is full. Do not leave the nozzle unattended while it is pumping, and do not “top off” or overfill the tank.
- A spark caused by static electricity could ignite gasoline fumes. Before touching the nozzle or fuel door, touch the vehicle door to release any static electricity. Do not reenter the vehicle during fueling because this builds up static electricity.
- While fueling, avoid using battery-powered devices, such as mobile phones, music players, or PDAs.

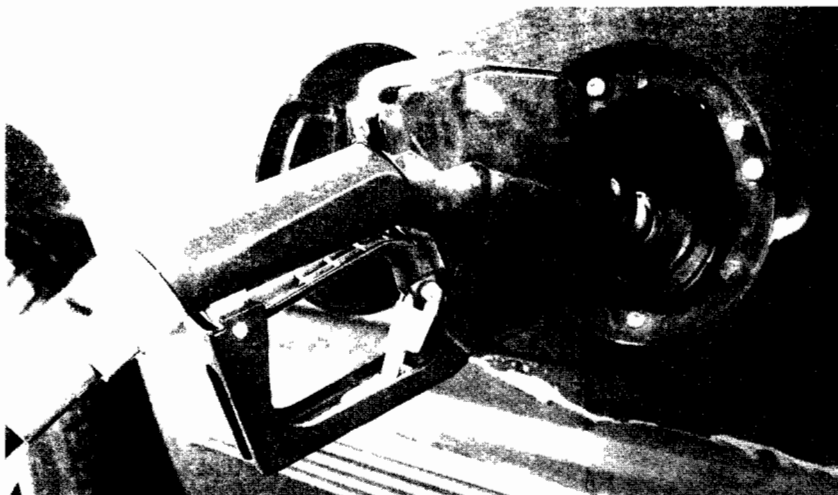

Safety in Your Home

Be aware of the dangers in your home and take steps to fix these problems to keep your home safe.

Accidents at Home

Fixing problems does not mean rebuilding your home to make it safe. Safety can be as simple as good housekeeping and getting rid of hazardous items. A safe home has a place for everything.

Take a close look at the things you can do to help prevent personal home accidents. Use the following Home Safety Checklist. It is a detailed accident-prevention guide for you and your family. If you follow the suggestions, they will soon become safety habits.



Only motor vehicle accidents cause more deaths than accidents at home, such as falling down stairs.

Home Safety Checklist

Check off each item that describes the situation in your home. Each item that gets no checkmark represents a potential hazard.

Stairways, Halls, and Outdoor Steps

- Stairways with three or more steps have a strong handrail and slip-resistant finish.
- Stairways and halls are kept free of boxes, toys, shoes, brooms, tools, and other tripping hazards.
- Gates at the top and bottom of stairs keep children from falling.
- The head and foot of stairs have no small or loose rugs.
- Stair carpeting or covering is securely fastened.
- Stairways and halls have adequate lights, controllable at either end.

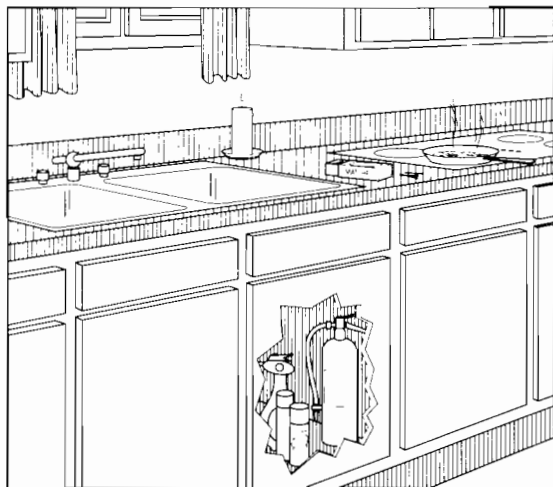

Find the five safety violations in this illustration.

Do not allow young children to operate garbage disposals, trash compactors, blenders, or other potentially hazardous appliances.

Kitchen

- Matches are kept where children cannot get them.
- Emergency numbers are posted next to the telephone, including 911 and poison control.
- Knives and sharp instruments are kept in a special knife drawer or holder, out of children's reach.
- Can openers do not leave sharp edges on cans.
- Lye, disinfectants, and cleaning products are kept out of children's reach.
- Pan handles are turned away from stove edges.
- Spilled grease, water, or bits of food are wiped up immediately.
- Pot holders are located near the stove, within easy reach.
- A dry chemical fire extinguisher is mounted near the stove.



Bathroom

- Tub and shower are equipped with strong handholds.
- Tub floor has a nonslip surface.
- Dangerous chemicals are clearly marked, sealed shut in the original container with adhesive tape, and kept out of children's reach.
- All medicines are out of children's reach and stored in childproof containers.
- All cabinets and drawers that contain medications are locked.
- No one takes medicine in the dark. Lights are turned on and labels read.

Attic and Basement

- Ladder is strong, solid, and sturdily constructed.
- Stairway is sturdy and well-lighted.
- Children keep skates and play gear in a specific place.
- Walls and beams are free from protruding nails.
- Fuses or circuit breakers are the proper size. (See the *Electricity* and *Home Repairs* merit badge pamphlets.)
- Rubbish and flammable materials are kept in covered metal cans until their disposal.
- Wastepaper is stacked neatly in a box or bag and is kept away from the furnace and stairs while awaiting disposal—clear of possible basement seepage.



Newspapers and wastepaper should be kept well away from stoves, fireplaces, furnaces, and heaters.

Living Room and Dining Room

- Furniture is arranged to allow easy passage.
- Before bedtime, furniture placement is checked for orderliness to prevent collisions in the dark.
- Furniture and woodwork are solid, in good repair, and free from splinters and rough spots.
- Fireplace screen fits snugly.
- Rugs are fastened or laid on nonslip pads.
- Rugs are kept from curling at their edges.
- Wax on floors is thoroughly buffed.
- Fire in fireplace is thoroughly extinguished at bedtime.
- Candles are in stable holders. Candles are carefully extinguished after use, before bedtime, or before leaving home. Do not leave a room that has a lit candle.

Bedroom

- Smoke alarm battery has been replaced within the past 12 months or has a secure electrical connection and is tested monthly. When replacing the battery, write the date on it with a permanent marker.
- Carbon monoxide alarm has a fresh battery or secure electrical connection and is tested regularly.
- Furniture is placed to allow clear passage between bed and door to avoid collisions in the dark.
- Light switch or lamp is within easy reach from bed.
- A night-light illuminates the bedroom or hall.
- Dresser drawers are closed when not in use.
- A bar across upper bunk bed helps prevent falls.
- Children are taught not to lean against windows or window screens.
- Low-sill windows have sturdy screens to prevent children from falling out.
- Smoking in bed is prohibited.
- Gas and electric heating devices are turned off at bedtime.

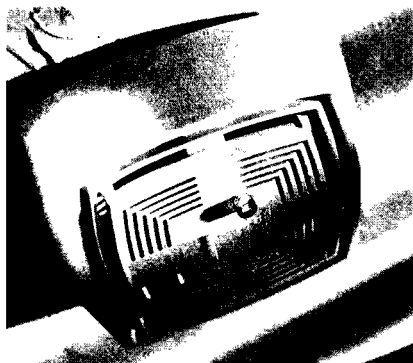

Nursery

- Bars on crib are no more than 2 3/4 inches apart so baby's head cannot slip between them.
- Crib is approved by Consumer Products or a similar consumer safety group.
- Crib is free from sharp edges or corners.
- Sleeping garments and covers keep baby warm without danger of smothering or strangling.
- Pillows are kept out of bassinet or crib.
- No thin, plastic material is in or near the crib.
- No toys or objects in the crib or within reach for any child under age 3 are less than 1 inch in diameter and 2 inches long. No toys or objects have small parts such as eyes that can be removed.
- Children are taught not to give marbles, jacks, or other small toys to children younger than age 3.
- Toys are sturdy, do not come apart easily, and have no sharp edges or points. Toys should have a consumer products group's approval.
- Non-toxic paint is used on baby furniture and toys.
- All houseplants are nonpoisonous.

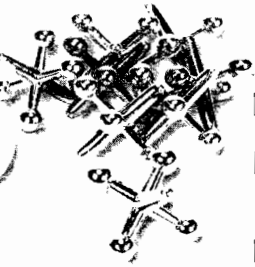

The Child Safety Protection Act of 1994 requires warnings on toys with small parts for children under age 6. Always choose age-appropriate toys without sharp edges or parts that can be swallowed.

Stoves, Furnaces, and Heaters

- Stoves are located away from windows to avoid setting fire to curtains.
- Stove and furnace pipes and flues are inspected and cleaned annually.
- Gas burners are properly adjusted and free from leaks.
- Water heater and all small gas or oil room heaters are equipped with vent pipes or flues to carry combustion gases outside the house.
- Water heater or boiler has a safety valve and is checked annually.
- Water heater temperature is set below 120 degrees Fahrenheit to reduce the risk of serious burns.
- Flames of gas burners are protected from drafts.
- An insulating shield protects woodwork within 18 inches of any furnace, stove, or heater.
- Burnable materials are kept well away from stoves, furnaces, and heaters.
- An appropriate-size crescent wrench is stored near the shutoff valve of the outside gas line.
- The flue is opened before using the fireplace.

Porch, Yard, and Garage

- Railings and banisters are sturdy and inspected periodically.
- Steps and walkways are kept free from ice and snow.
- Yard and play space are free of holes, stones, broken glass, nail-studded boards, tools, and other litter.
- Tools and other dangerous articles are kept out of children's reach.
- Dangerous products and chemicals such as antifreeze, insecticides, cleaning fluid, and lubricants are kept in the original container, locked in storage areas, and used according to the manufacturer's instructions on the container.
- Wires and low fences are brightly painted or marked with cloth strips to make them clearly visible.
- Wells, cisterns, and pits are kept securely covered.
- Disposable materials are not burned outside.
- An area is marked off in the garage for bicycles, wagons, and other small vehicles.
- Lawn mower is equipped with proper safeguards.

If your family has a pool or spa tub, it may be wise to post rules as a reminder for family members and guests to keep safety in mind at all times. Have emergency numbers handy, and make rescue equipment easily accessible (and know how to use these devices, too.)

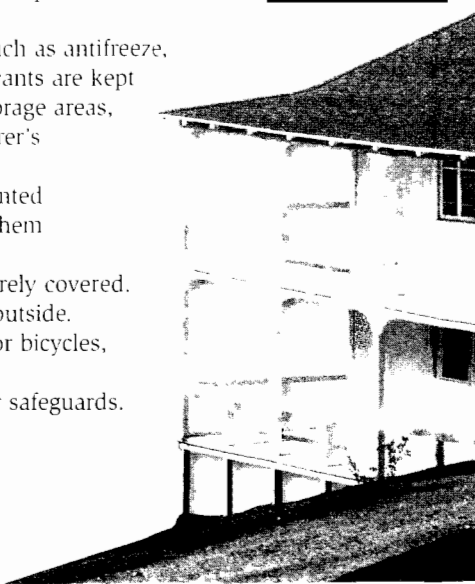

Be sure you have received proper training and have adequate supervision before operating power tools and lawn care equipment.

Workshop and Power Tools

- Safety goggles (or face shield), hearing protection, and appropriate clothing, including shoes, are worn when working with or around power tools. Appropriate eyewash is available.
- Good ventilation exists, especially when sanding or painting. Dust masks or respirators are worn when suggested by the tool or product manufacturer.
- Baking soda is kept handy to neutralize acid burns.
- All electrical tools are either grounded with three-wire plugs or clearly marked as double-insulated.
- Work area is free of clutter, including lumber scraps and oily rags.
- Lighting over work area is adequate.
- All tools and accessories have a place. Tools and accessories are kept in their place except when being used on a project.
- Guards are in place on all power tools.
- A "push stick" is used with table saws. All saw guards and shields are kept in place.
- Tools are unplugged when not in use and before changing blades, servicing, and repairing.



Electrical Devices and Fixtures

(Check for hazards in all rooms where electrical fixtures are located.)

- Electrical fixtures and appliances are located and used beyond arm's length of sink, stove, tub, shower, or other grounded metal objects unless the outlet is protected by a ground-fault circuit interrupter. Ground-fault protected outlets are tested regularly.
- No one touches electrical fixtures or appliances with wet hands or while standing on a wet floor.
- Seldom-used electrical appliances are disconnected when not in use.

- Household appliances are disconnected before repairs or adjustments.
- Light bulbs are installed in all lamp sockets.
- Frayed and worn electrical cords are promptly replaced.
- Long trailing cords are not visible.
- Cords are kept out from under rugs, doors, and movable furniture.
- Extension cords are UL-approved and the proper wire size for the load.
- Children are taught never to touch electrical sockets or fixtures.
- Fuses are adequate for the load and are not bypassed.
- Circuit breakers are labeled and are not overloaded.

General

- Home has a smoke and carbon monoxide alarm system, with at least one alarm in each bedroom and additional alarms in the living room, basement, and garage.
- Everything has a place and is kept there when not in use.
- A strong, rigid stepladder is kept in good repair and stored out of the way.
- Window screens and storm windows are securely fastened.
- Guns are stored unloaded and in locked cases.
- Guns and ammunition are stored separately.
- Children are permitted to use only blunt-end scissors.
- Clothing worn for housework is free from drooping sleeves, sashes, or frills.
- Shoes worn for housework and home repairs have low heels and are in good repair.
- Kerosene, gasoline, paint thinners, and other volatile materials are stored outside in special, clearly marked metal containers.
- Oil mops, dust rags, painting equipment, and other greasy materials are stored in open metal containers.
- Everyone turns on a light before entering a dark room.
- Matches are extinguished before they are discarded.
- Children are never permitted to play with matches.
- Fire extinguishers are readily available and in good working order.
- The house is free of rodents, spiders, and other pests.
- Unwanted paint, chemical, or aerosol containers are promptly discarded in a safe and environmentally sound manner.

Firearms Safety

If your family is among the 50 percent of households in the United States that keeps firearms in the home, help make sure all guns are kept secured, inaccessible to those who should not use them—especially children and your friends who visit. Any ammunition also should be securely and separately stored. If you encounter a firearm, do not touch it. Report it to a responsible adult or law enforcement agent.

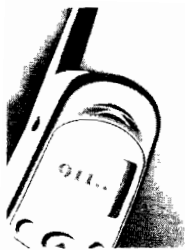

For more information about first aid, see the *First Aid* merit badge pamphlet and the *Boy Scout Handbook*.

For Emergency

- Know the 911 emergency number. (Dial 0 if the 911 emergency system is not available in your area.)
- Know the location of water, gas, and electric shutoffs, and be sure each shutoff is checked at least once a year.
- Have a first-aid kit, approved by your doctor or the American Red Cross, and replenish supplies as needed.
- Know basic first-aid procedures.
- Have a fire escape plan from your home (see later in this chapter).
- Have emergency water supplies stored in your home in case the primary water supply fails.
- Have handheld flashlights readily available for emergency use.
- Know how to get emergency help for any member of your family.

Precautions Against Bloodborne Viruses

Treat all blood as if it were contaminated with blood-borne viruses. Do not use bare hands to stop bleeding. Always use a protective barrier and wash exposed skin areas with hot water and soap immediately after treating a victim. The BSA recommends that the following equipment be included in all first-aid kits. This equipment should be used when rendering first aid to those in need.

- Protective gloves, to be used when stopping bleeding or dressing wounds
- A mouth-barrier device, for rendering rescue breathing or CPR
- Plastic goggles or other eye protection, to prevent a victim's blood from getting into a rescuer's eyes in the event of serious arterial bleeding
- Antiseptic, for sterilizing or cleaning exposed skin areas, particularly if there is no soap or water available



Your chances of escaping from a house fire are greatly improved if your family has an escape plan, including a main escape route and an alternate route.

Your Family Escape Plan

Home fires are deadly. They often happen at night when families are asleep. In the time it takes people to wake up and make their escape, a house fire can become an inferno. Also, deadly poisonous gases can spread throughout the home.

The best way to avoid injury or death in a home fire is to get out quickly. Escaping from a fire in the home sounds easy, but often people get trapped inside. Many fire victims are untouched by flames but are asphyxiated (smothered) by smoke or gases. A fire that never leaves the basement can kill everyone on the second floor because hot air and smoke rise.

The only way to be reasonably sure of escaping a fire is to have a plan. And, in case the fire keeps you from using your main escape route, there should be an alternate procedure. The National Safety Council recommends the following family escape plan. (Because every house and every family are different, use these rules to develop your own family escape plan.)

Having working smoke alarms gives families the warning time they need to make a safe escape.

- **Keep bedroom doors closed at night.** Closed doors will delay the spread of fire and keep out deadly smoke and gases.
- **Draw a floor plan of your home.** Lay out an escape route for each room on each floor. Then choose an alternate route for each room in case the planned escape route is blocked by fire. Give special attention to the bedrooms, because fires at night are usually the most potentially deadly. In an emergency situation, sheetrock walls can be broken using a tool or even kicking to allow you to escape.

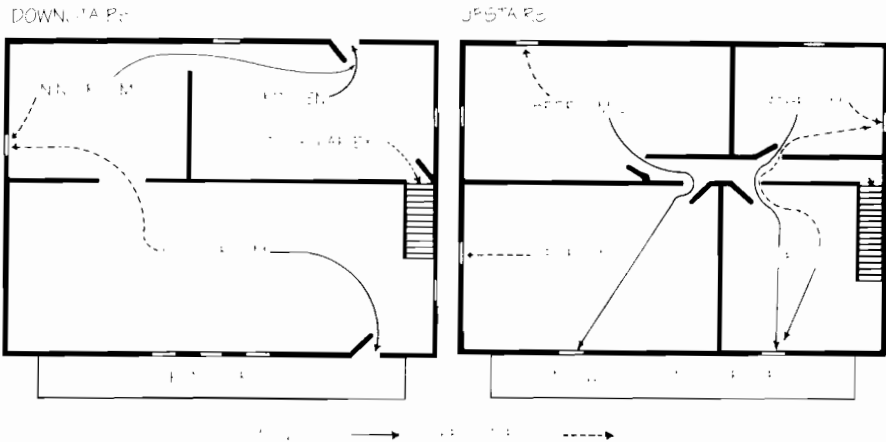

Family escape plan

- **Plan how to help young children and disabled or elderly people to escape.** Children and seniors will need help in any escape plan. You must plan ahead to protect their safety.
- **Have a way for every member of the family to awaken the others.** You do not know who might discover a fire while others are sleeping. You cannot count on being able to reach all bedrooms; some may be blocked. Yelling, pounding on walls, or blowing whistles may arouse others. Whistles are inexpensive—buy one for every bedroom in the house.
- **Teach everyone to escape without wasting time.** Getting dressed or gathering valuables will use up precious time.



Explain to young children that a firefighter with breathing apparatus might look scary, but they must go with the firefighter.

- **Teach everyone how to test a door.** Rub your hand along the door from the bottom to the top. If cool, check the knob. If any part is hot, leave the door closed and take another route.
- **If you must stay in a room, close the door and stay near a slightly opened window.** Stuff door cracks with towels or clothing. If you are trapped, blow your whistle to help a rescuer locate you. In a smoke-filled room, crawl with your head as close to the floor as possible for visibility, heat reduction, and lower smoke toxicity.
- **Decide on a meeting place outside,** like a neighbor's front porch, preferably across the street. When you have all gathered there, you will know that everyone is safe.
- **Activate the emergency response system as soon as you can by calling 911. If your community does not have that service, dial 0.** Do not stop to call 911 from inside a burning building; go to safe area outside. Teach everyone how to use different kinds of phones, including mobile phones. Post family emergency numbers such as poison control, the family doctor, and parents' work and mobile numbers near every telephone in the house. Make copies for everyone to carry with them.

Find out if your local emergency number is able to track your address, as most can today. If you do not have this service,

post your address next to each phone in the house. In a crisis, even adults have been unable to think of their address. On the phone, speak clearly and state your emergency, name, and address. Do not hang up until the other person does.

- **Hold a practice drill.** Repeat the drill from time to time, making changes to allow for a new family member, different sleeping arrangements, or other changes in your family or home.

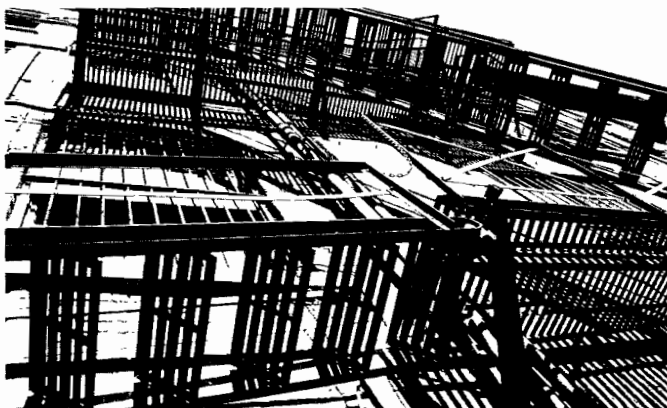

Some Cautions About Your Escape Plan

As you prepare your family escape plan, keep the following cautions in mind:

- Make sure escape windows can be opened—including screens and storm windows.
- Beware of windows that are high, painted shut, or blocked by an air conditioner. These make poor or impossible escape routes.
- Teach everyone how to break a window with a chair or other heavy object and to clear away remaining pieces of glass with a shoe, or cover broken glass with a blanket, pillow, or towel.
- Unless they open onto some area of refuge like a roof or deck, second-story windows need an emergency ladder, rope, or other means of escape. If time allows, bedding can be used in an emergency to aid an escape (by tying sheets together to make a rope) or cushion a fall. If you must jump to save your life, realize that you can recover from broken bones.

Major Disasters

As you read the newspaper or watch TV newscasts, you may see that major disasters can be grouped in the following two ways:

- Things that disrupt your entire community, such as earthquakes or floods
- Accidents, such as a house fire or wind damage, that are centered on your home and do not involve the whole community



During a communitywide disaster such as massive flooding, outside help might not reach you immediately.

Think about what kinds of natural and human-caused disasters and emergencies could occur in your community. What should your family do? If disaster strikes only your home, as in a fire, your home might be destroyed but help from the outside would arrive quickly. During communitywide disasters, such as hurricanes or tornadoes, outside help might take days to arrive. You must be prepared to survive a communitywide disaster using only the resources in your home or an emergency shelter.

Major Disaster Preparedness Items

We all hope to never face a major catastrophe that threatens our survival. But major disasters do happen to ordinary people. Be prepared for them. Plan to store enough supplies for everyone in your household for at least three days. Also, assume you might have no electric power, water, or phone. Store the following items, and periodically inspect perishable, usable items like batteries and medications to ensure that they are current and fresh.



- One gallon of **water** per person per day
- Nonperishable, high-protein **food** items, including energy bars, ready-to-eat soup, peanut butter, and foods that require no refrigeration, cooking, and little or no water
- Food and water** for pets
- First-aid kit** (including supplies of specific medicines used by family members)
- Copies of the **Boy Scout Handbook and Fieldbook** (which describe the procedures for many emergency situations and the proper first aid for many common injuries)
- List of **emergency telephone numbers** (911 may be the only number needed in your area)
- Large **flashlight** with extra **batteries**
- Portable, battery-operated **radio** with extra **batteries**
- Fire extinguisher**
- Tool kit**, including an ax, shovel, broom, screwdriver, pliers, hammer, coil of half-inch rope, coil of baling twine, plastic or

duct tape, knife, razor blades, pen, paper, and adjustable wrench for turning off gas and water

- Simple chart showing where **shutoff valves** are located, including the main electrical switch
- Plastic sheeting** and **garbage bags** with ties
- Portable fire **escape ladder** for homes or buildings of more than one story
- Manual **can opener**
- Cash** (ATMs and credit cards require electricity)
- Wooden **matches**, dipped in liquid wax and stored in a waterproof container (not to be used until it is certain there are no gas or chemical leaks or spills)
- Portable stove** that uses butane or charcoal (used outdoors only because carbon monoxide poisoning is fatal)
- Gloves and cloths** for cleaning up chemical spills
- Covered containers** (capable of being tightly sealed) for storing refuse
- Clothing, sturdy shoes, and gloves** for each member of the household (sealed in plastic to keep them dry)
- Garden hose** kept near an outside faucet at all times
- Medications** (prescription and nonprescription) and **sanitary items** like toilet paper
- Map** of the local area with your evacuation route marked
- Copies of **valuable documents**, like insurance papers, enclosed in a waterproof bag
- Personal identification and a list of medications** needed for all family members

Calling 911

In most communities, dialing 911 will connect you with a dispatcher for fire, police, and ambulance. Usually, the address you are dialing from appears on the emergency dispatcher's screen.

However, an estimated 30 percent of 911 calls come from mobile phones. Unlike a home or business phone, a caller using a mobile phone could be calling from anywhere. Realize that when calling 911 from a mobile phone, the dispatcher will need an address or location description that might include the closest city or road.

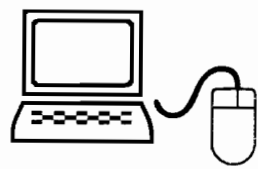
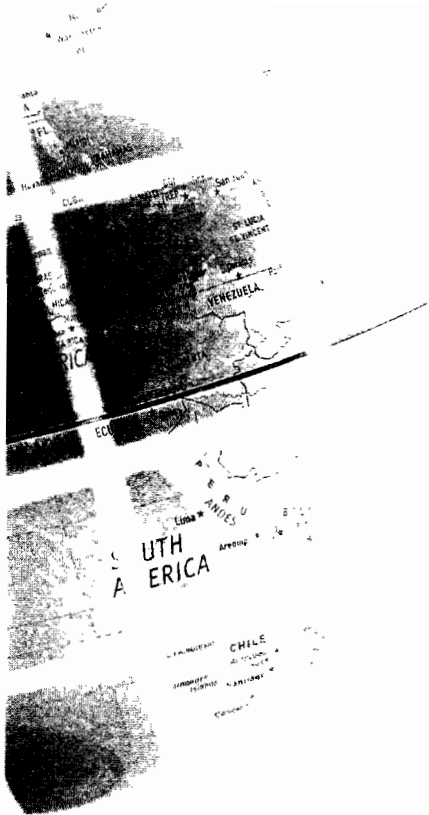

Safety Online

The tips in this section will help you stay safe and protect your identity when surfing the Internet. Before you log on to the Internet, make sure you have your parent's permission. Your parents, counselor, or librarian might discuss other precautions with you.

Besides having an abundance of useful and accurate information, the Internet also has its dark side, including misinformation. Talk with your counselor or other experienced Internet users about ways to tell the difference.



Never give out personal information to anyone you meet online.

- **Follow your family's rules for using the Internet.** Respect any limits on how long and how often you are allowed to be online and what sites you can visit. Your family also can consider installing a software program that helps weed out undesirable sites.

Families should locate their household computer in an open, shared area, never in an isolated place like an attic room.

- **Protect your privacy.** Never exchange electronic pictures of yourself with strangers. Never give out personal information such as your telephone number, address, last name, where you go to school, or where your parents work, without first asking your parent's permission.
- **Do not open e-mails or files you receive from people you do not know or trust.** If you get something suspicious, put it in the trash just as you would any other electronic junk mail, which is known as spam. Many computer viruses are sent via e-mail attachments. You should have updated virus protection software and, especially with cable or DSL connections, a firewall. A firewall will help prevent a hacker from obtaining information from your computer or placing information and viruses on it.
- **If you receive or discover any information that makes you uncomfortable, tell your parents and let them look at it.** Do not respond to any message that is disturbing or hurtful.
- **Never agree to get together with someone you meet online, unless your parents approve of the meeting and go with you.**
- **Never share your Internet password with anyone other than your parents or other responsible adults in your family.** Sometimes a fraudulent e-mail will appear official (like from a company you use) and will request personal information.

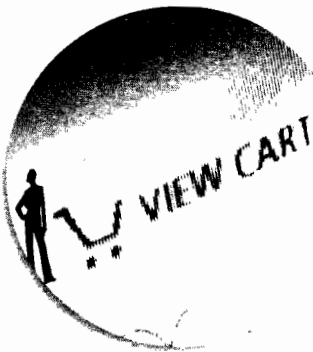

- **Never shop online or offer a credit card number unless you have your parent's permission.**
- **Be a good online citizen.** Do not do anything that harms others or is against the law. Any information you post online, such as notes and personal remarks, can be shared with others. A good rule of thumb is to not post information you do not want others, including strangers, to see.

Identity Theft

Identity theft is the fastest-growing crime in the United States. When a criminal steals someone's personal information to impersonate this person and make legal transactions, it is identity theft.

Online identification. Be careful not to share personal information about you or your family including birth dates, address and phone numbers, your mother's maiden name, and especially Social Security numbers. A criminal can use this information to apply for credit cards that can be sent directly to the criminal's address.

Online purchases. Do not purchase anything online from a merchant unless you have your parents' permission. You also need a secure server. You know you have a secure server when the Web address begins with "https" instead of "http."

The following are common old-fashioned— not online—ways that your identity can be stolen:

Stolen wallets and purses. Encourage your parents to reduce the number of identification and credit cards they carry in their wallet or purse in case of theft. They should especially not carry anything that includes a Social Security number.

Mailbox. Unless your mailbox is locked, you can help protect your family members' identities by promptly removing the daily mail.

Trashy treasure. Criminals rummage through home and business trash for personal information. Personal information, especially credit card applications, should be shredded.

If your parents fall victim to identity theft, tell them they can contact the Federal Trade Commission (FTC) at the toll-free telephone number, 877-IDTHEFT, or online at <http://www.consumer.gov/idtheft>.



Get in the habit of looking for exits in the public places you enter.

Safety in Public Places

Public places include schools, theaters, places of worship, office buildings, and parks—any place outside the home where people gather.

Public places generally are safe. Laws demand that public places undergo regular safety inspections. Public places must be built according to the latest safety codes and have adequate supervision of the facilities. Yet, accidents can still happen. And when accidents happen in public places, they can be very serious.

The Hazard of Panic

Panic is giving in to a sudden, overpowering fear. When people panic, they may feel they must run for their lives. Panic anywhere can be dangerous, especially in a public place.

Imagine that you are in a theater and someone suddenly shouts, "Fire!" Everyone reacts at once. People rush for the door through which they entered the theater. In the madhouse of people trying to escape, some fall and are trampled. Panic attacks have caused serious accidents and even death.

What can you do to avoid these dangers? First, learn how to prevent your own panic. Do not give in to terror, because fear will cloud your judgment. Second, learn how to keep others from panicking or causing panic. Set an example through your own self-confidence in the face of trouble.

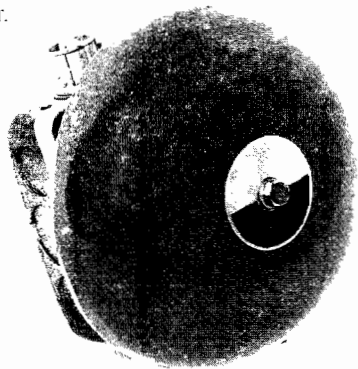

Fire drills at school prepare students to leave the building safely in case of a real fire emergency.

Be prepared before trouble strikes. Get into the habit of looking for exits in any public place you enter. Ask yourself, "How can I get out of this building if there is any trouble? How can I help other people to get out?" Think of at least two ways to exit public buildings you enter. Both should be exits other than the door where you entered. This actually gives you three possible escape routes.

You can help others by encouraging them to leave through exits other than the door they used to enter the building. That door is the most dangerous exit to use in case of panic, because most people will try to get out through that single entrance. As soon as a few start using alternate exits, others will follow.

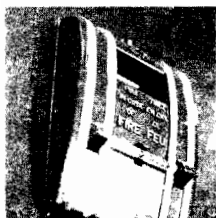

In case of fire in a multistory building, do not use an elevator. During a fire, the elevator shaft becomes a chimney. An elevator may even stop and the doors open automatically where the fire is most intense. Use the stairs and fire escapes to reach safety.

Safety in Recreation

Every type of recreation has its own safety rules. Learn the safety rules for any sport, game, or recreational activity in which you will participate.



Always keep flames well away from tents. No tent material is fireproof.

No Flames in Tents

Camping is a major activity for any Scout. Scouts need to pay special attention to fire safety when camping. Remember that no tent material is fireproof. All tents can burn when exposed to heat or fire. Also, fires give off poisonous carbon monoxide in even a ventilated tent. For safety in tents, use the following rules:

- Never use liquid-fuel stoves, heaters, lanterns, lighted candles, matches, or other flame sources in or near tents. Permit only flashlights and electric lanterns in tents.
- Do not pitch tents near open fire.
- Do not use flammable chemicals near tents, including charcoal lighter fluid, spray paint, bug killer, or insect repellent.
- Be careful when using electricity and lighting in tents.
- Always extinguish cooking and campfires properly.
- Obey all fire laws, ordinances, and regulations.

Safe Swim Defense Plan for Units

The Safe Swim Defense plan has been used successfully for years to help Scouting units swim safely. The plan gives Scouts an understanding of the basic principles of group swimming under adequately supervised, safe conditions. Here are the points of the plan

- 1. Qualified Supervision.** All swimming activity must be supervised by mature and conscientious adults age 21 or older. These adults must accept responsibility for the well-being and safety of youth members in their care. They must be experienced in the water and confident of their ability to respond in the event of an emergency. They must be trained in and committed to compliance with the eight points of BSA Safe Swim Defense. (It is strongly recommended that all units have at least one adult or older youth member currently trained as a BSA Lifeguard to assist in the planning and conduct of all swimming activity.)

For more information about the BSA's Safe Swim Defense, see the *Boy Scout Handbook* and the *Swimming or Lifesaving* merit badge pamphlet.

2. Physical Fitness. Require evidence of fitness for swimming activity with a complete health history from physician, parent, or legal guardian. The adult supervisor should adjust all supervision, discipline, and protection to anticipate any potential risks associated with individual health conditions. In the event of any significant health conditions, the unit leader should require proof of an examination by a physician.

People with physical disabilities can enjoy and benefit from aquatics if the disabilities are known and necessary precautions are taken.



3. Safe Area. When swimming in areas not regularly maintained and used for swimming activity, lifeguards and swimmers should systematically examine the bottom of the swimming area to determine varying depths, deep holes, rocks, and stumps. Mark off the area for three groups:

- No more than 3 feet deep for nonswimmers
- From shallow water to just over the head for beginners
- Deep water not more than 12 feet for swimmers

Participants should not be permitted to swim in areas where they cannot easily recover and maintain their footing. They should avoid areas where they cannot maintain their position on the water, either because of swimming ability or water flow. When setting up a safe swimming area in natural waters, use poles stuck in the bottom or plastic bottles, balloons, or sticks attached to rock anchors with twine for bouy/dary markers. Enclose nonswimmer and beginner areas

with buoy lines (twine and floats) between markers. Mark the outer bounds of the swimmer's area with floats. Be sure that clear-water depth is at least 7 feet before allowing anyone to dive into the water. Diving is prohibited from any height more than 40 inches above the water's surface. Feetfirst entry is prohibited from more than 60 inches above the water. For any entry from more than 18 inches above the water surface, clear-water depth must be 10 to 12 feet. Only surface swimming is permitted in turbid water. Swimming is not permitted in water over 12 feet deep, in turbid water where poor visibility and depth would interfere with emergency recognition or prompt rescue, or in whitewater, unless all participants wear appropriate personal flotation devices. The supervisor must also determine that swimming with personal flotation equipment is safe under the circumstances.

4. Lifeguards on Duty. Swim only where there are lifeguards on duty. For unit swims in areas without stationed lifeguards, the supervisor should designate two capable swimmers as lifeguards. Station them ashore, equipped with a lifeline (a 100-foot length of $\frac{3}{8}$ -inch nylon cord). In an emergency, one carries out the line. The other lifeguard feeds it out from shore, then pulls in his or her partner and the person being helped. In addition, if a boat is available, have two people, preferably capable swimmers, take it out—one rowing and the other equipped with a 10-foot pole or extra oar. Provide one guard for every 10 people in the water. Adjust the number and positioning of guards as needed to protect the particular area and activity.

5. Lookout. Station a lookout on the shore where it is possible to see and hear everything in all areas. The lookout may be the adult in charge of the swim and may give the buddy signals.

6. Ability Groups. Divide participants into three ability groups:

- Nonswimmers
- Beginners
- Swimmers

Keep each group in its own area. Nonswimmers have not passed a swimming test. Beginners must pass this test: Jump feetfirst into water over the head in depth, level off, and swim 25 feet on the surface. Stop, turn sharply, resume

Teens, more than any other age group, suffer from diving injuries, which include paralysis and even death. Think about safety before you jump or let a friend jump.

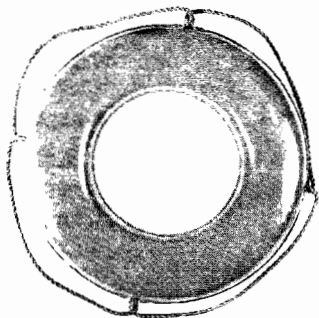

swimming as before and return to the starting place. Swimmers pass this test: Jump feetfirst into water over the head in depth. Level off and swim 75 yards in a strong manner using one or more of the following strokes: sidestroke, breaststroke, trudgen, or crawl (the stroke used in a swim meet freestyle event); then swim 25 yards using an easy resting backstroke. The 100 yards must be completed in one swim without stops and must include at least one sharp turn. After completing the swim, rest by floating. These classification tests should be renewed annually, preferably at the beginning of the season.

Use the buddy system whenever you go swimming.



- 7. Buddy System.** Pair every youth with another in the same ability group. Buddies check in and out of the swimming area together. Emphasize that each buddy lifeguards his or her buddy. Check everyone in the water about every 10 minutes, or as needed, to keep the buddies together. The adult in charge signals for a buddy check with a single blast of a whistle or ring of a bell and a call of "Buddies!" The adult counts slowly to 10 while buddies join and raise hands. They remain still and silent. Guards check all areas and count the pairs. They compare the total with the number of swimmers known to be in the water. Signal two blasts or bells to resume swimming. Signal three blasts or bells for checkout.
- 8. Discipline.** Be sure everyone understands and agrees that swimming is allowed only with proper supervision and use of the complete Safe Swim Defense. The applicable rules should be presented and learned prior to the outing. These rules should be reviewed for all participants at the water's edge just before the swimming activity begins. Scouts should respect and follow all directions and rules of the adult supervisor. When people know the reason for rules and procedures, they are more likely to follow them.



More than 700 people die each year in boating accidents. Their lives might have been saved if they had been wearing life jackets, commonly called PFDs or personal flotation devices.

Safety in Public Swimming Areas

You can use the BSA's Safe Swim Defense plan while swimming with your family or any other group. Do not swim at a public pool or beach unless the management provides a safe area, lifeguards, and lookouts. Make sure to read and follow the posted rules and regulations.

At a public pool or beach, be sensible and keep within the proper area for swimmers of your ability. Always swim with a buddy, regardless of where you are swimming. If a check-in and check-out plan is not provided by the management, make arrangements to provide one for your own immediate group. Your plan could be as simple as a scribbled list of swimmers by buddies, with each name crossed off as the person leaves the pool. Of course, any Scouting group must always obey all the rules posted by the management as well as use the Safe Swim Defense.

Lightning Strikes

Severe thunderstorms can develop quickly, so always be alert to the weather. The National Weather Service says if you can hear thunder, you are close enough to the storm to be struck by lightning. During thunderstorms, take these precautions.

- Avoid open areas and lightning targets such as trees, flagpoles, or wire fences.
- Avoid anything metal, which conducts electricity. Remove and stay away from metal-framed backpacks. In tents, stay away from metal tent poles.
- Water conducts electricity; if you are on or in the water, get to land immediately.
- If you are hiking near mountaintops, which are struck by lightning often during summer, get downhill. If a storm catches you, take shelter in a cave or low spot among the rocks and in an area that is not likely to flood.
- Take shelter in a steel-framed building or hard-topped motor vehicle (not a convertible) if you can. Such places are safe because the charge stays within the building's or vehicle's frame and is conducted safely to ground without endangering the occupants. If you are taking shelter in a car, avoid touching the metal parts.
- When taking shelter in a building, remember that water and metal conduct electricity. Avoid water and anything metal. Do not take a bath or shower or run water. Do not use the telephone or any objects connected to electrical power, such as hair dryers, TVs, and computers.
- If you cannot find shelter, *get small*. Do not lie flat on the ground, which makes you a bigger target than crouching down. If you feel your hair stand on end or your skin get tingly, crouch down immediately. Squat on the balls of your feet, cover your ears with your hands, and put your head between your knees. The less of you that is touching the ground, the better.

Other Scouting Activities

Other Scouting activities that have their own safety rules include things like rifle and shotgun shooting, archery, hiking, canoeing, sailing, skiing, and horseback riding. Set an example in all of your activities by learning and following the rules for each activity that you do.

Learn and follow the safety rules for every activity you do.

Blasting Cap Dangers

Blasting caps are small metal tubes about as big around as a pencil and up to 7 inches long. Blasting caps are essential tools in construction, mining, quarrying, prospecting, and agriculture to set off other explosives.

Only experts should use blasting caps. Occasionally, caps are mislaid or stolen. In inexperienced hands, they can cause serious injury or death. If you find something that might be a blasting cap or a detonating cord, *do not touch it*. Report it promptly to the nearest police, sheriff, fire department, or military unit.

Fireworks

Fireworks also are considered explosives and require special safety tips. Fireworks are not an approved BSA activity. According to the U.S. Eye Injury Registry, approximately 12,000 people are treated annually in the United States for fireworks-related injuries. Nearly half of those injured are bystanders, and about 2,000 of these injuries involve the eye.

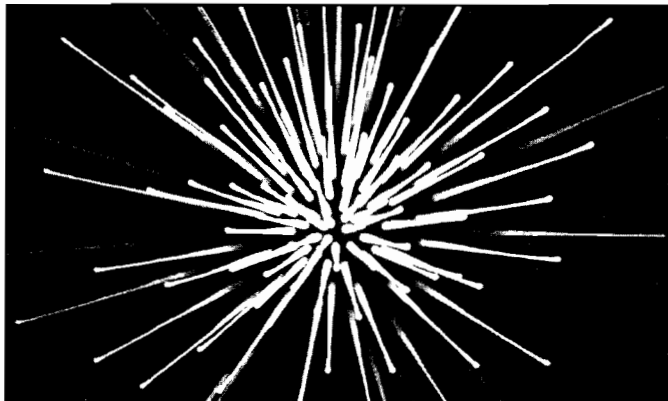



Safety Plans and Projects

To fulfill the last two requirements for the Safety merit badge, you must do some careful accident-prevention planning and complete a safety project.

Accident Prevention Planning

As a young adult, you will need to look out for your own safety more and more. This exercise will help you learn to think like a safety technician by developing an accident prevention plan.



What potential safety hazards could mar this family's fun?

You must have your merit badge counselor's approval before you begin your safety project. Discuss the details with your counselor, who can give you many tips on the types of projects to consider.

Safety Projects

Planning and completing a safety project may take you outside your home and into the community or your place of employment. If you do a project for the whole community, you will also need to involve community leaders. For projects at your workplace, be sure to get proper approval before proceeding.

Your project probably will not be a one-person undertaking. You can involve Scouts who are also working for their Safety merit badges, or any other Scouts who might be interested in this effort. You will do the planning and direct the efforts of other people. In other words, the success of the project will be in your hands.

Any terrorist event in the United States is a federal crime.

The Homeland Security Advisory System

Because of the terrorist attacks on September 11, 2001, President George W. Bush and Congress established the U.S. Department of Homeland Security. This government agency analyzes threat information. Homeland Security uses a color-coded system to communicate the current risk of terrorist attack. If the level of threat changes, state and local governments, industries, and the public—that includes you—need to

know, so that everyone can help protect against terrorist attacks. Know the colors associated with the threat levels so that you can advise others.

With your parents' permission, check the Homeland Security Web site to find out the current level of terrorist risk.

Explore the site to learn how to prepare for, or help prevent, an attack. For more information, see the resources section at the end of this pamphlet.



Homeland Security Advisory System on Risk of Terrorist Attack:
Code Red, severe; Code Orange, high; Code Yellow, elevated;
Code Blue, guarded; Code Green, low

Types of Projects

As you decide what type of project you want to do, consider opportunities in your home and community. One Scout organized a bicycle safety program for his troop. In the Scout's small town, the troop program spread to be a citywide event. Bikes were inspected on weekends. Experts gave instruction in safe riding, and a "safe bike" riding contest was the highlight of the safety campaign.



Your safety project could involve learning about home security—and maybe even sharing what you learned with others.

Another kind of safety project might be more useful or appropriate in your neighborhood or community. The suggestions listed here will get you thinking about specific projects to discuss with your counselor.

- With your Scout leader's permission, stencil "No Flames in Tents" on the flaps of your unit's tents.
- Conduct a safety poster contest, with posters placed in neighborhood store windows.
- Develop an emergency evacuation plan for your troop meeting place.

- Make copies of the Home Safety Checklist in this pamphlet and distribute the copies to homes in your area.
- Keep kids safe during the Halloween season by collecting donated flashlights and reflective tape from local hardware stores and distributing them to parents of small children. The Centers for Disease Control estimates four times as many children between ages 5 to 14 are killed on Halloween than on any other night of the year.



- Order and post in your place of worship a set of safety posters. Be sure to get permission from both your place of worship and parents before you do. Posters may be ordered for free from the Web site of the Church Mutual Insurance. (See the resource section at the end of this pamphlet.)
- Plan and build a safety float for a parade such as a school or community event, or Scoutorama.
- Plan and run a safety booth at a fair.
- Conduct a study of the books and other materials on safety that are available in your local library. Create a list of additional resources that could be added such as books, pamphlets, and videos. Present this list to the librarian and explain that you are working on the Safety merit badge.



- Work with the local police to organize a Neighborhood Watch in your area. For information on organizing a Neighborhood Watch program, see the *Crime Prevention* merit badge pamphlet.
- After using the Home Safety and Home Security checklists, plan and complete a project to update your home in all areas that are shown to be deficient.
- If you live on a farm, you will probably choose a farm safety project. A farm is a good place for a project because there are so many kinds of safety hazards posed by farm machinery, pesticides, flooding, lightning, electricity, and other dangers. See the *Farm Mechanics* merit badge pamphlet or contact the National Safety Council for its material on farm safety.
- With your parent's permission, visit the National Highway Traffic Safety Administration's Web site, <http://www.safercar.gov>. Make a chart or a poster of the safety star ratings for a passenger car, a pickup, an SUV, and a van. Then present what you learned to your counselor, Scout unit, or a Cub Scout pack.

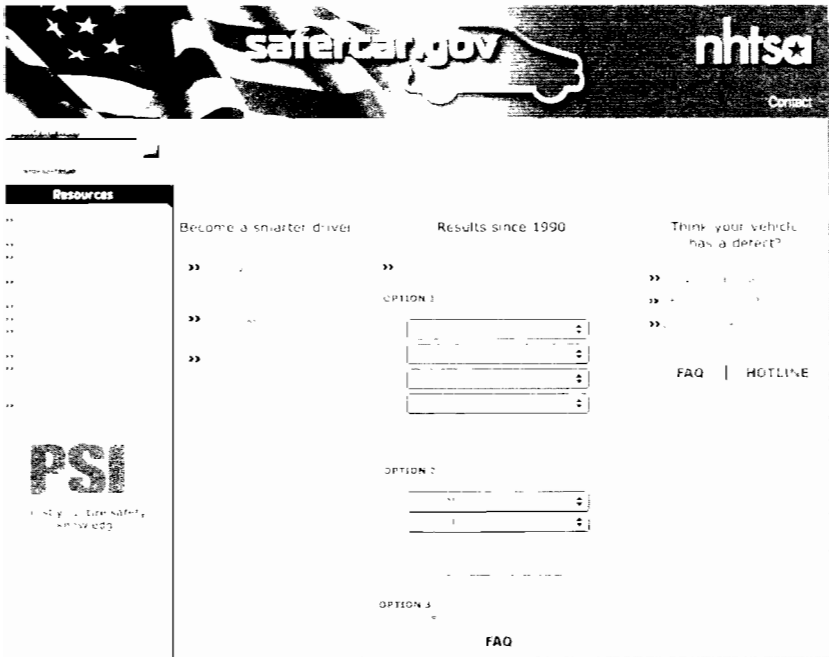



Careers in Safety

Saving and protecting the lives of other people can be a rewarding career. There are many career opportunities in the fire and rescue realm.

Fire and Rescue Service

Firefighters rescue people, but they also raise ladders, hook hoses to water hydrants, and enter burning buildings. Fire inspectors help prevent fires from happening by checking buildings to be sure fire ordinances, laws, and codes are followed. Fire investigators are like detectives. By using clues left after the fire, they determine the starting point and cause of the fire. Fire safety technicians also work to prevent fires by planning fire protection systems like the ceiling sprinkler systems in public buildings.

To be a firefighter, you must have a high school diploma. Fire investigators, inspectors, and safety technicians must have two to four years of college in one of the following programs: fire service, fire protection, fire technology, or fire protection engineering. In addition, a position may require state fire protection certification, paramedic certification, public education specialist certification, or other special qualifications.

In most fire departments, an applicant for a fire inspector, investigator, or technician needs two or more years of experience as a firefighter.

Safety Engineer

A safety engineer is responsible for reducing or minimizing the number of preventable accidents in the workplace by anticipating hazardous conditions. Often this is in a warehouse or a manufacturing, chemical, or oil and gas plant. Educating employees in safe practices and promoting pride in the number of hours worked accident-free also are important parts of a safety engineer's responsibilities.

Several years of experience as either a safety technician or assistant safety engineer are often required to obtain a safety

engineering position. In addition, certification as a safety engineer or safety consultant in the state in which you wish to work is recommended.

A four-year degree in industrial engineering is preferred.

Law Enforcement

A detective needs a memory for detail, good verbal and writing skills, and a curious mind.

Law enforcement agents such as police officers have a wide range of responsibilities to protect the public. They enforce the law, preserve the peace, control crowds, and arrest and stop criminals, among other duties. Detectives obtain information about criminals and their activities through surveillance, interviews, and research.

A high school education is required, but a two- or four-year college degree in law enforcement is preferred. Another option is joining the armed forces, which offer law enforcement training. A detective needs a wide range of knowledge, so a four-year college degree in general studies is preferable.

Candidates must pass a written test that checks for intelligence and the ability to understand police work. Candidates also are checked for character and to verify they have no arrest record. Physical fitness for strength and agility is also an important qualification.

After being hired, a police officer typically must pass special training and then work side-by-side with an experienced officer for several months. Usually only a police officer with at least three years of experience may apply for a detective position.

Other Careers in Safety

Risk Management. Municipalities, insurance companies, research institutes, safety advocacy organizations, and other companies and organizations, including the Boy Scouts of America, have risk managers who assess the safety of activities.

Code Enforcement. Private companies, city governments, trade groups, and other organizations have code enforcement personnel that assess the implications of safety codes on the trades and the consumers.

Fire Marshal Services. All types of municipalities have persons trained in how fires start and the damages that can occur.

Occupational Safety Analysis. Industry and government hire experts in industrial functions and products to anticipate how on-the-job accidents can occur and how they can be prevented.

Safety Advocates. Organizations, companies, and consumer groups employ consultants to advocate safety in the environment, transportation community, and institutions.

Safety Resources

Scouting Literature

Boy Scout Handbook (including *How to Protect Your Children From Child Abuse*), *Safe Swim Defense*, *Safety Afloat*, *Climb On Safely*, and *Fieldbook: Crime Prevention, Emergency Preparedness, Fire Safety, First Aid, Lifesaving, and Wilderness Survival* merit badge pamphlets

Books

American Red Cross. *American Red Cross Community First Aid and Safety*. American Red Cross, 2002.

———. *American Red Cross First Aid: Responding to Emergencies*. Staywell, 2001.

Are You Ready? An In-Depth Guide to Citizen Preparedness (IS-22). FEMA, 2004. Order a free copy at 800-480-2520.

Berardelli, Phil. *Safe Young Drivers: A Guide for Parents and Teens*. Nautilus Communications, 2000.

Brown, Cooling. *Home Emergency Guide*. DK Publishing, 2002.

Heberle, David, and Richard Scutella. *The Complete Guide to Making Your Home Safe*. Betterway Books, 1998.

Lee, Laura. *100 Most Dangerous Things in Ever day Life and What You Can Do About Them*. Broadway Books, 2004.

Morkes, Andrew, ed. *Careers in Focus: Public Safety*. Ferguson Publishing, 2001.

Sharing the Roadway: Motorists and Motorcyclists in Traffic. Motorcycle Safety Foundation Inc., 2004.

Vacca, John R. *Identity Theft*. Prentice Hall, 2003.

Warde, John. *The Healthy Home Handbook: All You Need to Know to Rid Your Home of Health and Safety Hazards*. Three Rivers Press, 1997.

Organizations, Government Agencies, and Web Sites

AAA Foundation for Traffic Safety

607 14th St. NW, Suite 201
Washington, DC 20005
Telephone: 202-638-5944
Web site: <http://www.aaafoundation.org>

American National Standards Institute

1819 L St. NW, 6th floor
Washington, DC 20036
Telephone: 202-293-8020
Web site: <http://www ansi.org>

American Red Cross

2025 E St. NW
Washington, DC 20006
Telephone: 202-303-4498
Web site: <http://www.redcross.org>

**American Society of
Safety Engineers**

1800 E. Oakton St.
Des Plaines, IL 60018-2187
Telephone: 847-699-2929
Web site: <http://www.asse.org>

ASTM International

100 Barr Harbor Drive
P.O. Box C700
West Conshohocken, PA 19428-2959
Telephone: 610-832-9585
Web site: <http://www.astm.org>

Church Mutual Insurance

Web site: http://www.churchmutual.com/index.php/choice/risk/page/rm_posters/id/36

**Federal Emergency
Management Agency**

500 C St., SW
Washington, DC 20472
Toll-free telephone: 800-621-FEMA
Web site: <http://www.fema.gov>

Motorcycle Safety Foundation

2 Jenner St., Suite 150
Irvine, CA 92718-3800
Toll-free telephone: 800-447-4700
Web site: <http://www.msfsa.org>

National Fire Protection Association

1 Batterymarch Park
Quincy, MA 02169-7471
Telephone: 617-770-3000
Web site: <http://www.nfpa.org>

**National Highway Traffic
Safety Administration**

400 Seventh St., SW
Washington, DC 20590
Toll-free telephone: 888-327-4236
Web site: <http://www.nhtsa.dot.gov>

National Safety Council

1121 Spring Lake Drive
Itasca, IL 60143-3201
Telephone: 630-285-1121
Web site: <http://www.nsc.org>

**National Youth Sports
Safety Foundation**

One Beacon St., Suite 3333
Boston, MA 02108
Telephone: 617-367-6677
Web site: <http://www.nyssf.org>

**Occupational Safety and
Health Administration**

200 Constitution Ave., NW
Washington, DC 20210
Toll-free telephone: 800-321-OSHA
Web site: <http://www.osha.gov/>

Recreation Safety Institute

39 Shadyside Ave.
Ronkonkoma, NY 11779
Telephone: 516-883-6399

Safe Kids Worldwide

1301 Pennsylvania Ave. NW, Suite 1000
Washington, DC 20004
Telephone: 202-662-0600
Web site: <http://www.safekids.org>

**Students Against Destructive
Decisions (SADD)**

255 Main St.
Marlborough, MA 01752
Toll-free telephone: 877-SADD-INC
Web site: <http://www.sadd.org>

Underwriters Laboratories Inc. (UL)

333 Pfingsten Road
Northbrook, IL 60062
Telephone: 847-272-8800
Web site: <http://www.ul.com>

U.S. Consumer Product Safety Commission

4330 East-West Highway
Bethesda, MD 20814-4408
Toll-free telephone: 800-638-2772
Web site: <http://www.cpsc.gov>

U.S. Department of Homeland Security

Web site: <http://www.rcadv.gov>

U.S. National Library of Medicine

8600 Rockville Pike
Bethesda, MD 20894
Web site: <http://www.nlm.nih.gov>

Acknowledgments

The Boy Scouts of America is grateful to the following for their assistance in preparing this 2006 edition of the *Safety* merit badge pamphlet.

- Members of the Safety merit badge review committee, in particular Sven Rundman (chair), Norman Butman, Mike Donaghue, Ed Haywood, Glen Henderson; Tom Seymour, and Tom Watson

- Members of the BSA Health and Safety Committee, in particular David Bell, Ph.D.; William W. Forgey, M.D., John E. Hendrickson, American Red Cross National Headquarters; Charles Mitchell, National Rifle Association of America, Arthur H. Mittelstaedt Jr., Ph.D., Recreation Safety Institute; and Paul Young, R.S., M.P.H.
- Bryan Caldwell, retired captain, Hawaii County Fire Department
- Michele Campbell and Kevin Fearn, Research and Statistics Department, National Safety Council
- Ralph W. Russell II, Institute of Electrical and Electronics Engineers

Special thanks to staff members of the Recreation Safety Institute, Ronkonkoma, New York, for providing their assistance, time, and expertise. The BSA also thanks the American Library for its assistance with the resources section of this pamphlet.

For their contributions to the 1997 edition of the *Safety* merit badge pamphlet, upon which this new edition is closely based, the BSA thanks Dr. Dale Brannom, Police Chief William E. May, and the National Safety Council.



TXU

The Boy Scouts of America is grateful to TXU Electric Delivery for providing expertise, photo assistance, time, and other resources in the production of this

new edition of the *Safety* merit badge pamphlet. In particular, thanks to Tom Baker, Gordon Bius, Tim Burke, Gailee Cardwell, Ray Cumpton, John Frentress, Lonnie Green, Jay Greene, Bill Harper, Art Miller, Carol Peters, and Randy Smith.

Additional assistance was provided by Frederick L. Hines and a special committee of the American Society of Safety Engineers, R. B. Wangler, chairman.

Photo and Illustration Credits

Church Mutual Insurance Company,
courtesy—page 72 (*bottom*)

Photos.com—pages 9, 10 (*both*),
15 (*bottom*), 29 (*all*), 36, 38 (*right*),
40 (*top*), 41, 42 (*top*), 43, 46, 49,
50, 52 (*left and center*), 54, 56, 59,
60 (*top*), 74, 75, and 77 (*all*)

safercar.gov/National Highway Traffic
Safety Administration—courtesy—
page 73

Terrorism Research Center,
<http://www.homecloudsecurity.com>,
courtesy—page 70

All other photos and illustrations not mentioned above are the property of or are protected by the Boy Scouts of America.

Dan Brvant—page 52 (*right*)

Darrell Bvers—page 42 (*bottom*)

Daniel Giles—pages 8, 33, 47, 51,
and 67 (*top*)

Roy Jansen—pages 4, 7, 27 (*bottom*),
28, 31, 32, and 55

John McDearmon—pages 20 (*all*),
30 (*both*), 35, and 39

Randy Piland—page 65

Brian Payne—pages 12, 58, and
60 (*bottom*)

Steve Seeger—page 67 (*bottom*)