

MERIT BADGE SERIES



PIONEERING



BOY SCOUTS  OF AMERICA®

HOW TO USE THIS PAMPHLET

The secret to successfully earning a merit badge is for you to use both the pamphlet and the suggestions of your counselor.

Your counselor can be as important to you as a coach is to an athlete. Use all of the resources your counselor can make available to you. This may be the best chance you will have to learn about this particular subject. Make it count.

If you or your counselor feels that any information in this pamphlet is incorrect, please let us know. Please state your source of information.

Merit badge pamphlets are reprinted annually and requirements updated regularly. Your suggestions for improvement are welcome.

Send comments along with a brief statement about yourself to Boy Scout Division • Boy Scouts of America • 1325 West Walnut Hill Lane • P.O. Box 152079 • Irving, TX 75015-2079.

WHO PAYS FOR THIS PAMPHLET?

This merit badge pamphlet is one in a series of more than 100 covering all kinds of hobby and career subjects. It is made available for you to buy as a service of the national and local councils, Boy Scouts of America. The costs of the development, writing, and editing of the merit badge pamphlets are paid for by the Boy Scouts of America in order to bring you the best book at a reasonable price.



BOY SCOUTS OF AMERICA
MERIT BADGE SERIES

PIONEERING



BOY SCOUTS  OF AMERICA®

Note to the Counselor

Because this *Pioneering* merit badge pamphlet will be used throughout the United States, merit badge counselors should understand that not every method can be fully described here. Different parts of the country might use other names for a knot, a method, or a piece of equipment. Counselors may employ other methods described and illustrated in other Scouting literature.

Some pioneering skills or methods called for in the requirements will take practice and time to master. Therefore, having multiple hands-on sessions to earn the merit badge is advisable. The term “demonstrate” in the requirements means just that—the Scout should show that he has learned the skill and can use it.

Keep in mind that, because of equipment availability, parts of some requirements might have to be done at summer camp, at district or council events, or on a troop camp outing. In such cases, *the person conducting the review and approving any partial completion must be approved to do so by the local council.*

The appearance of a finished project or structure is not as important as the correctness of individual knots and lashings. The project should be judged for its structural soundness, to determine if it was built to safely withstand the use for which it was intended. Only the approved designs shown in this pamphlet or other Boy Scouts of America literature are recommended.

In earning this merit badge, the Scout has a chance to learn skills that will be useful in a wide variety of Scouting and non-Scouting activities. These skills should become an ongoing part of a Scout’s advancement and his growing participation in new and challenging adventures. Earning the Pioneering merit badge could equip him to later teach younger Scouts, or could add another dimension to his value as a camp staff member.

Planning ahead, making certain as you go, and ensuring safety go hand in hand with the Scout motto, Be Prepared. In pioneering, discipline is essential. Pioneering is a challenge that can instill long-term habits of doing things right the first time.

Requirements

1. Show that you know first aid for injuries or illness that could occur while working on pioneering projects, including minor cuts and abrasions, bruises, rope burns, blisters, splinters, sprains, heat and cold reactions, dehydration, and insect bites or stings.
2. Do the following:
 - a. Successfully complete Tenderfoot requirements 4a and 4b and First Class requirements 7a, 7b, and 7c. (These are the rope-related requirements.)
 - b. Tie the following: square knot, bowline, sheepshank, sheet bend, and roundturn with two half hitches.
 - c. Demonstrate the following: tripod and round lashings.
3. Explain why it is useful to be able to throw a rope, then demonstrate how to coil and throw a 40-foot length of $\frac{1}{4}$ - or $\frac{3}{8}$ -inch rope. Explain how to improve your throwing distance by adding weight to the end of your rope.
4. Explain the differences between synthetic ropes and natural-fiber ropes. Discuss which types of rope are suitable for pioneering work and why. Include the following in your discussion: breaking strength, safe working loads, and the care and storage of rope.
5. Explain the uses for the back splice, eye splice, and short splice. Using $\frac{1}{4}$ - or $\frac{3}{8}$ -inch three-stranded rope, demonstrate how to form each splice.
6. Using a rope-making device or machine, make a rope at least 6 feet long consisting of three strands, each having three yarns.

7. Build a scale model of a signal tower or a monkey bridge. Correctly anchor the model using either the 1-1-1 anchoring system or the log and stake anchoring method. Describe the design of your project and explain how the anchoring system works.
8. Demonstrate the use of a rope tackle by lifting a weight of 25 pounds and pulling a log at least 6 inches in diameter and 6 feet long with the tackle. Use the tackle to put tension on a line. Explain the advantages and limitations of using a rope tackle. In your explanation, describe the potential damage that friction can do to a rope.
9. By yourself, build an A-trestle OR X-trestle OR H-trestle using square and diagonal lashings. Explain the application of the trestle you build. Demonstrate how to tie two spars together using a shear lashing.
10. With a group of Scouts OR on your own, select a pioneering project and get your counselor's approval before you begin building. With your counselor's guidance, create a rough sketch of the project. Make a list of the ropes and spars needed, then build the project. (Note: This requirement may be done at summer camp, at district or council events, or on a troop camp outing.)

Contents

Pioneering Past and Present	6
Pioneering Safely	9
Rope	17
Knots	28
Splicing Rope	40
Making Rope	46
Anchors and Rope Tackle	53
Lashings	59
Pioneering Projects	71
Pioneering Resources	95



Pioneering Past and Present

Scouting's founders believed that pioneering was an important way for Scouts to gain confidence in their abilities and to be prepared to make the most of outdoor experiences.

Pioneering—the knowledge of ropes, knots, and splices along with the ability to build rustic structures by lashing together poles and spars—is among the oldest and most honored of Scouting's skills. Practicing rope use and completing projects with lashings also allow Scouts to connect with past generations, ancestors who used many of these skills as they sailed the open seas and lived in America's forests and prairies.

Knots, splices, and lashings are formed today the same ways they have been done for a long time. Whether built as models or full-sized structures in the field, the pioneering projects you complete will look very much as they would have at any time in Scouting's history.

Of course, there are a few differences. One important change in pioneering is Scouting's deep commitment to the principles of Leave No Trace. *Where* pioneering projects are built can be every bit as important today as *how* they are built. Protecting the environment, using appropriate materials, and removing all evidence of your activities after an event lie at the heart of responsible Scouting—and pioneering—in the 21st century.



Scouts follow the principles of Leave No Trace wherever they participate in outdoor activities—including pioneering. Planning and preparing will help ensure that you have chosen the right place for your activities and that the materials you use come from environment-friendly sources.

- Select durable surfaces for building pioneering projects to minimize the trampling of vegetation, and arrange for access to toilet facilities.
- Follow all Leave No Trace principles to be certain you are also respecting wildlife that make their homes in your pioneering project area.
- Be considerate of visitors who happen upon pioneering projects. Politely share information about what you are doing and about Scouting. Also give guidance that will help ensure their safety, perhaps by escorting them around a project in progress or by showing them where to stand while they watch.
- Minimize campfire impact by using a camp stove when a pioneering event includes cooking a meal. Where campfires are allowed, manage yours in a way that lets you remove all evidence it was ever there.
- Leave what you find, and leave the area in the same condition you found it. Dismantle structures when you are done with them, and store all building materials.
- Dispose properly of waste, and clean up all bits of rope and other building materials at the end of a pioneering event.

With its rich history and dynamic projects, pioneering pulls together the best features of Scouting. As you plan and build your pioneering project, make it a fun, safe, and positive adventure.

Pioneering the Leave No Trace Way

- Plan ahead and prepare.
- Travel and camp on durable surfaces.
- Dispose of waste properly.
- Leave what you find.
- Minimize campfire impacts.
- Respect wildlife.
- Be considerate of other visitors.

As you plan your pioneering projects, make sure you consult with your merit badge counselor along the way, and get your counselor's approval before you begin building.



Pioneering Safely

Building a scale model of a pioneering project involves few risks. However, constructing full-sized towers and bridges requires a keen eye toward safety. Manage risk during pioneering projects by being alert to your surroundings and by taking action whenever you notice a potential hazard. Doing so will help prevent accidents, avert emergencies, and ensure a fun, safe time.

Pioneering Safety Guidelines

Follow these guidelines whenever building and using pioneering structures.

- Dress for the weather. When necessary, wear gloves to protect your hands.
- Use ropes and materials that are in good condition and appropriate for the project.
- Coil and store ropes when they are not in use.
- Avoid wrapping a rope around your arm or waist when dragging or lifting a load.
- Do pioneering work only when it is nice outside, never during rainy weather or in wet conditions that can make ropes and spars slippery.
- Practice good body mechanics when lifting and hauling. Lift no more weight than you can handle safely.
- Use flagging tape to mark anchor lines, ropes stretched between trees, hanging loops of rope, and cords or ropes that could trip or entangle someone.
- Stand clear of any weight suspended by a rope.
- Stay off to the side of a rope that is *tensioned* (under strain from a load). A tensioned rope may snap back if it breaks, a knot comes loose, or an anchor gives way.

Managing risk includes being prepared to handle emergencies that might occur during pioneering.

Whenever you go pioneering, you and your group should have a first-aid kit onsite and know how to use it. In advance, discuss how to summon medical assistance in case of an emergency (usually by calling 911).

First-Aid Preparedness

Pioneering calls for knowledge of first aid. Make it a point to know how to respond in an emergency. Being prepared helps ensure that you and your pioneering friends will have glitch-free fun.

Cold- and Hot-Weather Factors

Hypothermia occurs when the body's core temperature drops so low that it can no longer keep warm. Hypothermia can happen in relatively mild weather, but cool, windy, and rainy weather are particularly dangerous. Prevent hypothermia by staying warm and dry and eating plenty of energy foods (nuts, dried fruits, peanut butter). Do not push yourself to a dangerous point of fatigue. Early signs of hypothermia include bluish lips and shivering. As the victim becomes colder, the shivering will stop. Other symptoms may include fatigue, irritability, and disorientation. Begin treatment for hypothermia by removing damp clothing and warming the person. Prevent further heat loss; move the victim to a shelter and cover the head for warmth. If the victim is able to swallow, offer hot drinks and food. Severe hypothermia requires immediate medical attention.



If you suspect hypothermia because someone is acting strangely, challenge the person to walk, heel to toe, a 30-foot line scratched on the ground. If the person shows unsteadiness, loss of balance, or other signs of disorientation, take immediate action to get the victim warm and dry.

Dehydration, or lack of water in the body, can occur at any temperature if a person is sweating profusely and/or not drinking enough liquids. Avoid dehydration by drinking plenty of fluids and eating enough throughout the day. Do not wait to drink until you feel thirsty. If someone in your group becomes weary or confused, or develops a headache or body aches, have the person rest in the shade and sip water until the symptoms subside.

Heat exhaustion is one result of dehydration. The body becomes overheated because its cooling methods fail. Watch for these signs: elevated body temperature (between 98.6 and 102 degrees); pale, clammy skin—even cool to the touch; heavy sweating; nausea, dizziness, and fainting; pronounced weakness and tiredness; headache; muscle cramps. To treat heat exhaustion, have the victim lie down in a shady, cool spot with the feet raised. Loosen the clothing. Apply cool, damp cloths to the skin, or use a fan. Have the victim sip water.

Heatstroke (sunstroke) is far more serious than heat exhaustion. Watch for these signs: body temperature above 102 degrees (often above 105 degrees); red, hot, and dry skin; no sweating; extremely rapid pulse; confusion or disorientation; fainting or unconsciousness; convulsions. The skyrocketing body temperature of heatstroke is life-threatening. Cool the victim immediately. Place the person in a cool, shaded spot face-up with head and shoulders raised. Remove outer clothing, sponge the bare skin with cold water, and soak underclothing with cool water. Apply cold packs, use a fan, or place the victim in a tub of cold water. Dry the skin after the body temperature drops to 101 degrees. Obtain medical help immediately.

Sunburn is a common but potentially serious result of overexposure to the sun. Long-term exposure can result in skin damage and skin cancer. To prevent sunburn, limit your exposure to the sun, wear loose-fitting clothing that covers the arms and legs, and wear a broad-brimmed hat to shade the neck and face. To protect exposed skin, apply sunscreen with a sun protection factor (SPF) of at least 15. Reapply sunscreen often and as needed.

The Boy Scout Handbook, Fieldbook, and First Aid merit

badge pamphlet give more detailed information about first aid.



Don't forget the ears and back of the neck when applying sunscreen.

Minor Injuries

Most minor injuries can be treated on the spot, without complications.

Minor cuts and abrasions usually require only cleaning and disinfecting with soap and water. Leave them to heal in the air, or cover lightly with a dry, sterile dressing or bandage to help prevent infection. Unless a cut is serious, bleeding probably will stop on its own or with slight pressure on the wound.

If a wound is so severe that it does not stop bleeding readily, apply direct and firm pressure using a sterile dressing or compress. It may help to raise the injured limb (if no bones are broken) above heart level. Apply pressure to the local artery. If the bleeding is prolonged, treat for shock and seek medical attention immediately.

Bruises bleed under the skin. Applying an ice pack to a bruise will reduce pain and swelling.

Rope burns, or friction burns, can happen when a rope slides too quickly through your hands or when any part of the body encounters a fast-moving rope. A rope burn leaves skin raw, red, and sometimes blistered. The best protection against rope burns on the hands is, of course, to wear protective gloves. If a burn does occur, clean the area with mild soap and water to help prevent infection.

A pioneering first-aid kit should include basic items for treating minor injuries and to provide initial care should a more serious emergency arise. Include a few adhesive bandages, two 3-by-3-inch sterile gauze pads, a small roll of adhesive tape, scissors, tweezers, one 3-by-6-inch moleskin, a small bar of soap, a small tube of antiseptic, a tube of 0.5 percent hydrocortisone cream, moleskin or molefoam for blisters, one roller bandage, a pair of latex gloves, plastic goggles or other eye protection, a mouth-barrier device (for rescue breathing or CPR), and a pencil and paper. This can all fit in a resealable plastic bag.

Always consider blood to be a potential source of infection; never touch someone else's blood with bare skin. Always use a protective barrier such as disposable gloves, and wash thoroughly afterward with soap and water.

Blisters form when skin is irritated, usually by friction or heat. A hot spot signals the beginning of a blister. Stop immediately and protect the tender area by cutting a piece of moleskin or molefoam and covering the affected area. If a blister forms, build up several layers of moleskin or molefoam, as needed, to take off the pressure. Blisters are best left unbroken. Treat a broken blister as you would a minor cut.

Remove **splinters** with tweezers. Encourage the wound to bleed to flush out foreign matter. Then wash with soap and water, and apply antiseptic. Cover with an adhesive bandage.

A **sprain** from twisting or wrenching a joint is usually quite painful and may swell. To treat a sprain, raise the injured area, apply cold compresses, and keep the victim still. For severe or persistent pain, seek medical attention.

Stings and Bites

No matter how much insect repellent you apply, insects will sting and bite, so pay attention where you walk and stand. Treat **ordinary insect stings** by scraping the stinger out with the blade of a knife. Do not try to squeeze it out; that will force more venom into the skin. Raise the affected part, gently wash the area, and apply hydrocortisone cream if available.

Fire ant stings can be extremely painful and—in some cases—cause a severe allergic reaction. You can spot fire ants by their distinctive loose mounds of dirt. When disturbed, these aggressive ants will swarm and attack as a group and sting repeatedly. Their stings form tiny blisters; take care not to break the blisters. Wash the injured area well with antiseptic or soap and water, then cover with a sterile bandage.

The stings of the **common scorpion** usually are not as dangerous as bee stings. The stings often cause severe, sharp pain, swelling, and discoloration, but generally leave no lasting ill effects. To relieve itching and pain from a common scorpion sting, apply ice packs or a cold compress if you have it. An over-the-counter antihistamine also can be given. If the victim has a history of allergic reactions to insect stings or shows signs of illness (persistent pain and swelling, numbness, breathing difficulties), and does not respond to the prescribed antidote, get medical help as soon as possible.

If you have it, apply 0.5 percent hydrocortisone cream to help soothe insect stings and bites.



Scorpion

Rarely, you might encounter a **venomous spider or scorpion**. Of particular concern are the bites of the black widow spider (identified by a red hourglass on the underside of its abdomen) and the brown recluse spider (recognizable by the fiddle-shaped mark on its back). Less common are stings from the venomous scorpions found in the desert areas of Arizona, California, and New Mexico. To treat a bite or a sting from one of these creatures, ice the area. Have the victim lie still and, if possible, keep the area lower than the heart. Tie a constricting band (loose enough to slip a finger between it and the skin) between the bite or sting and the heart. Treat for shock, and watch for difficulty in breathing; give rescue breathing if required. Seek immediate medical attention.

Ticks can carry diseases such as Lyme disease and Rocky Mountain spotted fever. Remove a tick as soon as it is discovered by grasping its head as close to the skin as possible with tweezers or gloved fingertips; gently tease the creature from the wound. Don't squeeze, twist, or jerk the tick; that could break off the mouthparts, leaving them in the skin. Wash the wound area carefully with soap and water or an alcohol swab, and apply antiseptic. After handling a tick, wash your hands thoroughly.



Always avoid direct contact with a tick because disease can be transmitted by finger contact.

Wasp, hornet, bee, or fire ant stings can cause severe **allergic reactions** in some people. Those people should take a field treatment kit with them on all outings, and their companions should be familiar with its use. If a sting reaction on an arm or leg is particularly severe, isolate its effect by tying a constricting band between the sting and the heart. The band must be loose enough for a finger to slide under it. Cool the wound with water (or ice, if available). Monitor the victim's breathing and do rescue breathing if necessary. Seek medical help.



Snakebite

If you are bitten by a snake, assume that it is venomous unless it can be positively identified. Learn to recognize venomous varieties to know when there's danger and what action to take.

Two types of venomous snakes are found in the United States. Pit vipers (rattlesnakes, copperheads, cottonmouths) have triangular-shaped heads with pits on each side in front of the eyes. Coral snakes have black snouts and bands of red and yellow separated by bands of black. Coral snakes inject a powerful venom that works on the victim's nervous system; pit viper venom affects the circulatory system.

Suspect a pit viper bite if there are puncture marks, pain and swelling (possibly severe), skin discoloration, nausea and vomiting, shallow breathing, blurred vision, and shock. A coral snake bite is marked by a slowing of physical and mental reactions, sleepiness, nausea, shortness of breath, convulsions, shock, and coma.

Get immediate medical help for the snakebite victim. While doing so, it is important to limit the spread of the venom and to maintain vital signs. Keep the victim still and the wound below the level of the heart. Tie a broad constricting band an inch or wider between the bite and the victim's heart (2 to 4 inches above the bite). Do not use constriction bands on fingers, toes, the head, the neck, or the trunk. Swelling may cause watchbands, rings, clothing, and shoes to restrict circulation; remove these items from the bite area. Treat for shock. Do not apply ice or give alcohol, sedatives, or aspirin.



Rattlesnake

Weather-Related Dangers

You should always remain aware of the weather, especially if lightning is in the area or is forecast. The weather doesn't have to be stormy or rainy for lightning to strike. Even if you don't see lightning, it can strike suddenly from gray, low clouds that could be rain clouds. Do not seek shelter under a tree or under an open shelter, and stay away from water. If a severe, sudden storm strikes, seek immediate shelter in a ravine, if possible. Before pioneering, always check the weather forecast. If severe weather is forecast, you may want to work on your scale model instead.



**Steps in whipping
the end of a rope**





Rope

Rope is among our oldest tools. Ancient peoples made useful lines by twisting or braiding roots, reeds, plant fibers, or strips of leather and used them to haul loads and harness animals. With rope, they could lash together tools, fishing nets, and shelters.

Rope is still important for work and for play. Without it, pioneering projects would be impossible. When choosing a rope for a pioneering task, consider how strong it is, how much it stretches, how easily it handles, and how well it resists mildew, rot, and exposure to sunlight. You will also want to note whether it is made of natural fibers or of synthetics.

Natural-Fiber Rope

Rope makers have settled on a handful of plants as the best producers of natural fibers for manufacturing ropes. Each has its advantages. The fibers most often used are manila, sisal, cotton, and coir.

Just as in prehistoric days, natural-fiber rope is still produced from plants. Fibers taken from stalks or leaves are twisted together to form thin *yarn*. Lengths of yarn are then twisted together in the opposite direction to form a thicker *strand*. Next, groupings of strands are twisted together, again in the original direction, to make a small rope. Finally, three of these small ropes are twisted together the opposite way to form the finished rope. The *lay* of the rope—the shape that results from alternating the directions for twisting the yarn, strands, and small ropes—allows a rope to hold its shape and resist unraveling.

To better understand the anatomy of a rope, take apart a short piece of three-strand natural-fiber rope. As you unravel the rope, notice how the smaller ropes, the strands, and the yarn have been twisted. Finally, unravel a single bit of yarn and you will find plant fibers—the raw material from which natural-fiber ropes are made.

Manila. Manila rope is made of fibers harvested from the leaf stems of the abaca plant (*Musa textilis*), a native of the Philippines. It takes its name from the city of Manila, the Philippine capital. Fibers can grow 10 feet long, making them ideal for constructing rope. Manila rope is easy to handle and, when new, has a smooth, silky feel. It is strong, does not stretch much, and is fairly resistant to the damaging effects of sunlight. For tying knots and making splices and lashings, quarter-inch manila rope is a good choice.

Sisal. Sisal fiber comes from a plant in the cactus family, *Agave sisalana*, found in arid regions of East Africa, Central America, and Mexico. (The name *sisal* comes from a small town in the fiber-growing region of Mexico's Yucatan peninsula.) Because the fibers are shorter than those of manila rope, sisal rope has only about two-thirds the strength of manila. Sisal fibers also have a tendency to splinter. This rope is not as flexible as manila and so is not as practical for lashings and for practicing knots. If knots in sisal rope become wet, kinks may remain in the rope after the knots are untied.

Cotton. The same cotton plant fibers used to make clothing can also be twisted or braided to form rope. Cotton rope is not very strong, but it is soft and easy to handle. It is ideal for clotheslines, tying up packages, and other uses that don't require it to bear much weight. Cotton rope is not useful for pioneering structures.

Coir. Originating in the islands of the Pacific, coir rope is made of fibers taken from coconut husks. It is a coarse rope, light in weight, that will float and is not harmed by salt water. The chief disadvantage of coir rope—and it is a big one—is that its very short fibers make it the weakest of major natural-fiber ropes. It is not recommended for use in pioneering projects, especially those that will bear weight.



Binder twine is made from loosely twisted fibers of sisal or jute that have been treated with chemicals during the manufacturing process. Its principal use is for tying bales of hay as they are formed in the field by baling machines.

The single-strand construction of binder twine gives it none of the strength that comes from twisting strands together to form the lay of a rope. Binder twine has a breaking strength of only a hundred pounds or less. It should *never* be used for pioneering projects except when lashing together camp gadgets that will bear little weight (such as a stand for a washbasin), and for making rope (see the “Making Rope” section later in this pamphlet).

Synthetic Rope

Synthetic rope is manufactured by twisting or braiding together fibers made from synthetic (mainly petroleum-based) materials, giving a variety of rope types that can be produced in almost any color and matched to many uses. Some synthetic ropes can be more vulnerable to sunlight than natural-fiber ropes. However, they generally resist rot and mildew better than natural-fiber ropes and, in many cases, are stronger.

Polyester. Polyester rope usually is found in braided, rather than twisted, form. This strong, durable rope handles well and doesn't stretch much. It is less affected by sunlight than most other synthetic fibers. Polyester rope is excellent for practicing knot tying and for use in pioneering work.

Nylon. Modern nylon rope is more than twice as strong as manila rope of the same diameter. It is available in braided form and twisted strands. Nylon rope has more stretch than other synthetic or natural-fiber ropes, but it recovers its original shape after tension from a load has been released. Nylon rope a quarter-inch in diameter works well for practicing knot tying and making lashings.



Parachute cord. A core of nylon strands covered with a braided nylon sheath, this cord takes its name from the role it plays with parachute rigging. It has a thousand uses around camp, from tent guylines to tying gear onto packs to hoisting food bags into trees as bear hangs. However, for pioneering projects, parachute cord can be used only for small projects (camp table, rack for drying clothes). The relatively low breaking strength of parachute cord (generally 200 to 500 pounds) means it should never be used for full-sized towers, bridges, or other weight-bearing pioneering projects.

Rope that will be used for climbing and rappelling—set aside at a Scout camp climbing program area or a Project COPE course, for example—must *never* be used for pioneering projects.

Polypropylene. Polypropylene rope will float, making it a good rope for waterfront activities and in wet conditions. Polypropylene rope handles well, but its slippery finish makes it unreliable for holding knots or forming secure lashings, especially when the rope is new. While polypropylene has about twice the strength of manila rope of equal diameter, it also stretches more. This rope can be used in pioneering projects as a line for pulling towers into position, as guy ropes anchoring structures in place, and as hand lines for monkey bridges. Its strength makes it suitable for anchoring systems and for any uses involving heavy strain. Its slippery surface reduces the friction of rope tackle systems.

Polyethylene. Polyethylene is an inexpensive braided rope. Knots and lashings will leave kinks in polyethylene rope that has been under tension, which makes it unsuitable for most pioneering projects. Polyethylene (also known as Dacron®) does float, giving it limited use at waterfronts, for example as towropes for water-skiers.

Kernmantle. Today, the only rope approved for BSA climbing and rappelling activities is nylon *kernmantle* rope. This strong rope has a core of parallel or braided nylon strands (the kern) surrounded by a woven nylon sheath (the mantle).

Breaking Strength and Safe Working Loads

New rope will have breaking strength and safe working load information printed on its packaging or included with the rope as a tag or pamphlet. The *breaking strength* of a rope indicates how many pounds of strain it will take before failing. The *working load strength* of a rope, usually less than 20 percent of its breaking strength, indicates the load the manufacturer recommends should not be exceeded.

A typical comparison of safe working loads and breaking strengths for new ropes of various kinds—in this case, ropes of $\frac{3}{8}$ -inch diameter—looks like this.

$\frac{3}{8}$ -Inch Rope	Approximate Safe Working Load*	Approximate Breaking Strength
Manila	122 pounds	1,220 pounds
Sisal	108 pounds	1,080 pounds
Cotton	90 pounds	900 pounds
Coir	65 pounds	337 pounds
Polyester	334 pounds	3,340 pounds
Nylon	278 pounds	3,340 pounds
Polypropylene	340 pounds	2,440 pounds
Polyethylene	410 pounds	3,725 pounds

*For exact load limits of a particular rope, see the manufacturer's information printed on spools or packages of new rope.

A rope's safe working load will diminish as it is used. Tension placed on the rope, exposure to the elements, and the effects of knots, lashings, and *drop loading* (using a rope to suddenly stop a moving weight) can all reduce rope strength.



Care of Rope

Construct pioneering projects only with rope that is safe to use.

Inspect the full length of a rope before and after a pioneering event to ensure there are no cuts or abrasions. Any rope that has cuts, abrasions, or more than a few broken fibers might need to be retired. The same is true if rope fibers have lost their luster and appear dry and brittle. Feel for lumps in braided rope and look for internal fiber puffing through the weave of the braid. A section of line that seems thinner than the rest of the rope can be another sign of a weak spot.

Twist open the lay of a natural-fiber rope in several places and inspect the interior fibers. Light-colored fibers suggest the rope probably is in good shape. A rope with a dark or spotted interior, or that smells bad, might not be safe to use.

Prolong a rope's useful life by taking care of it. The following guidelines will help you prevent rope from being damaged.



Damaged—and therefore unusable—rope

- Always step over a rope, never on it. Avoid dragging it along the ground where grit might get into the fibers.
- Protect rope from abrasion by using layers of canvas or tarp to shield it from sharp edges such as a cliff.
- Protect rope from heat, chemicals, petroleum products, and prolonged exposure to sunlight.
- Keep a rope under tension only as long as is necessary.
- Allow wet rope to air-dry completely before putting it into storage.

Storing Rope

Store rope the right way and it will be ready the next time you need it. Start by making sure the rope is clean and dry. Coil and hang pieces of cord and short lengths of rope on pegs, or stow them in clean cloth bags. For long ropes or ropes of large diameter, either coil the rope and hang the coil on a smooth round peg in a gear room, or loosely stuff the rope into a clean canvas duffle bag.

Drying Rope

Rope must be dry before it is stored. Damp or wet rope may develop mildew and rot. If a rope has become muddy and wet, rinse it off with a hose. Loosely coil the rope, hang it outdoors, and allow it to dry completely. Hasten drying by leaving space between the coils.

COILING A ROPE FOR STORAGE OR THROWING

Ropes can be coiled for storage or in preparation for throwing one end across a stream or over a tree branch. Begin every coil by removing any knots and hardware from the rope.

Coiling a thick rope for storage. Starting about 10 feet in from one end, drape lengths of the rope over the back of your neck so the loops hang down below your waist. When you are about 10 feet from the other end, remove the loops from your neck, grasp the two ends of the rope, and wrap them several times around the coil. Thread a bend of the remaining rope lengths through the coil, then pass the ends through the bend and pull it snug.

Coiling a thin rope or a cord for storage. Lengths of cord and ropes of small diameter can be coiled by laying loops of equal size in one hand. When only a few feet of rope or cord are left, use your other hand to wrap the remainder around the coil four or five times. Finish by passing a bend of the cord or rope through the coil, then run the end of the line through the bend and pull the end to snug the bend against the coil.

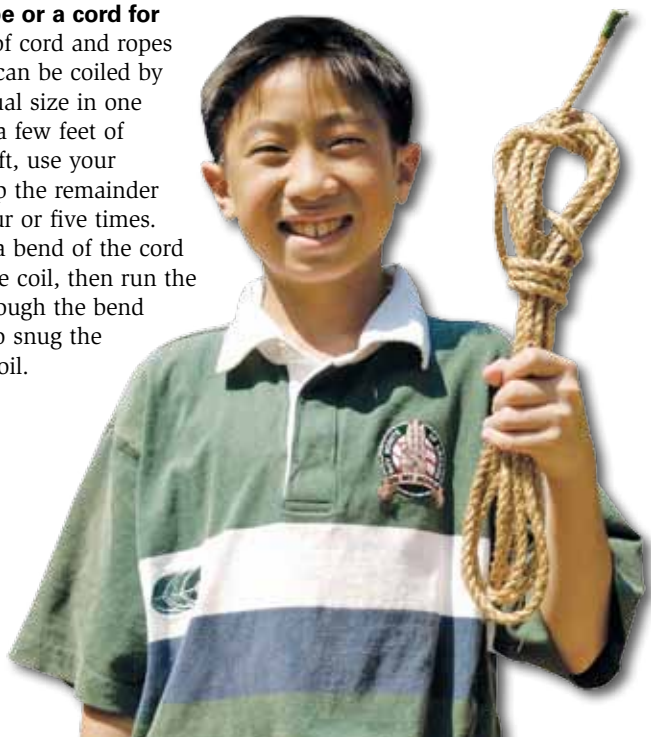



Coiling a rope for throwing. Tossing a rope over a tree limb or throwing a line across a creek is a challenging and fun skill. It can be important for setting up a bear hang to protect food in camp, for beginning a monkey bridge, for rigging a guyline on a signal tower, and for many other uses.

Secure one end of the rope so it doesn't take off when you throw the coil. Have a partner hang onto it, or tie it around a tree.

If the end of the rope is weighted, neatly coil the rope in your non-throwing hand. Place the coils next to one another so that when the rope is thrown, the coils run out smoothly without tangling. Throw the weighted sock or stuff sack either underhanded or overhanded toward the target.

If there is no weight on the rope, coil it neatly and hold it in your throwing hand. Swing the coil in an underhand motion, releasing all the rope at once and allowing it to uncoil as it moves toward the target.

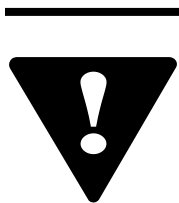

Never tie the rope to your wrist or around your waist. You may need to get rid of your end of the rope without becoming entangled in it.

Throwing a parachute cord or a rope with a diameter less than a quarter-inch might require adding a weight to one end. A sock or small stuff sack filled with sand works well. Attach it to the line with a clove hitch.

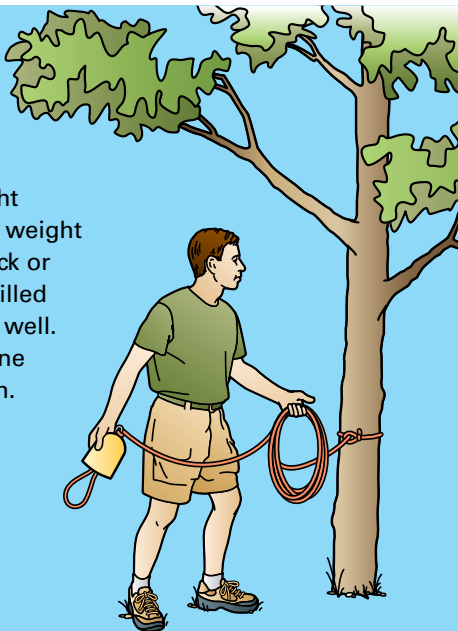

Fusing Rope Ends

Part of caring for rope includes preventing the ends from unraveling. For synthetic rope, that means fusing them. For natural-fiber rope, that means whipping the ends. The ends of three-strand ropes also can be protected with back splices.

Rope and cord made of synthetic materials will melt under high heat. An electric blade cutter, often found in stores that sell rope, is the safest means of neatly fusing rope ends. You can also use a match, butane lighter, or candle to fuse a rope. Working in a well-ventilated area, melt and fuse the strands by holding each rope end a few inches above the open flame.

Melted rope will be hot and sticky. Don't touch the end until it has cooled.

For instructions on making a back splice, see "Splicing Rope" later in this pamphlet.

Whipping Rope Ends

Because natural fibers burn rather than melt, the ends of manila, sisal, cotton, or other natural-fiber ropes are protected by whipping. Whipping keeps rope ends from fraying or unraveling by tightly binding them with strong cord. Among the styles of whipping are basic, West Country, and the sailmaker's.

Basic whipping. Every Tenderfoot Scout knows how to make a basic whipping to protect the end of a rope from unraveling. First, cut off any of the rope that has already unraveled.

Step 1—Using a piece of strong cord at least 2 feet long, form a loop. Lay the loop near one end of the rope.

Step 2—Tightly wrap, or *whip*, the cord around the rope.

Step 3—When the whipping is at least as wide as the rope is thick, slip the end through the loop and pull hard on the free ends to tighten the cord. Trim excess cord, then whip the rope's other end.

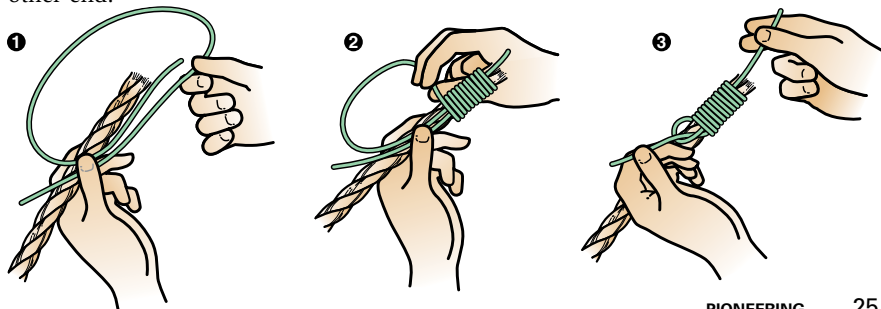
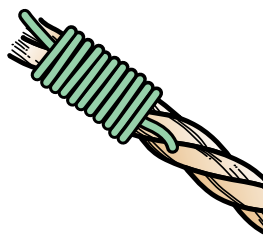

West Country whipping. Famous for seafaring traditions, the counties west of Bristol, England, lend the name West Country to a form of whipping that works well on any type of rope. The success of West Country whipping depends on the tightness and neatness of the knots formed with the whipping cord. To make the West Country whipping, start with about 14 inches of waxed flax cord.

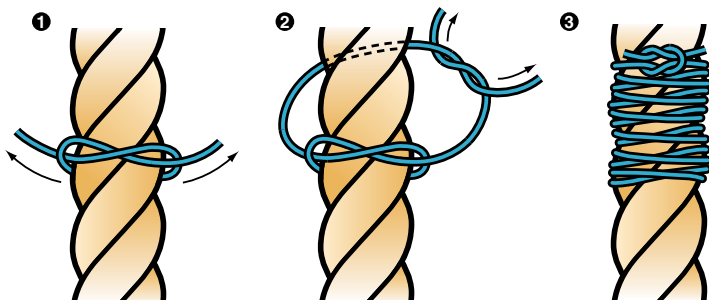

The best cord to use for whipping is waxed flax cord that can be purchased at leathercraft stores and shoe repair shops.

Step 1—Bring the cord around the rope near one end and secure the cord with an overhand knot.

Step 2—Take the two ends of the whipping cord around to the back of the rope (away from you), and tie another overhand knot.

Step 3—Continue to tie overhand knots, alternating them between the front and back of the rope, until the whipping has been formed. As a rule, make the whipping at least as long as the diameter of the rope.

Always tie each overhand knot the same way (for example, right over left, or left over right) so that the knots lie tightly together to form a smooth whipping. Finish the whipping with a square knot and trim the excess cord.

Ropes securing a ship's sails snapping in the wind can quickly fray if the ends have not been protected. The sailmakers of old knew that spending a little extra effort whipping rope ends would make their work much easier in the long run.

Sailmaker's whipping. The sailmaker's whipping can be used on three-strand rope. It differs from basic whipping in that the cord is secured around one of the rope strands before the whipping begins. That will help keep the whipping from coming off even if the rope is heavily used. Here is how to make the sailmaker's whipping.

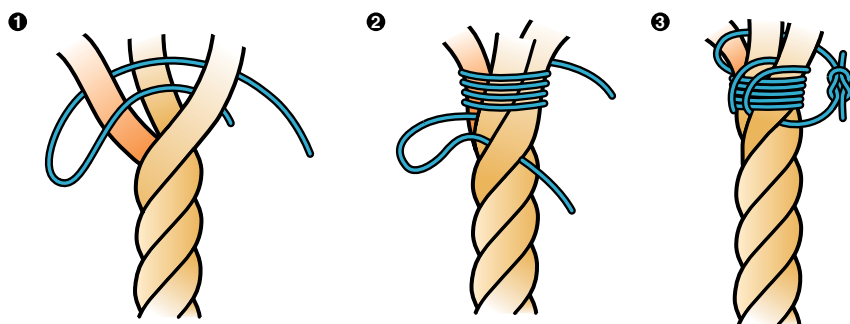

Step 1—Unlay the three strands for about 1 inch from the end of the rope. Form a bight near the end of a 16-inch length of cord and slip it over one rope strand, allowing several inches of the bight to remain. Lay the running ends of the cord between the other two strands of the rope.

Step 2—Twist the strands of the rope back together. Using the longer end of the cord, make wraps around the rope. Keep the wraps tight against each other.

Step 3—After completing the wraps, loop the bight over the end of the same strand around which it began. Run the longer end of the cord through the bight, then pull the two ends of the cord to tighten the bight against the whipping. Finish by tying the ends of the cord with a square knot and trimming the excess cord.

Fuse the ends
of three-strand
synthetic rope
before whipping.

Knots

Three tests of
a good knot:

- It is easy to tie.
- It stays tied.
- It is easy
to untie.

Most knots used today have been around for centuries. They have endured because the way they're formed—their architecture—has proven to be ideal for certain uses.

Knots and Rope Strength

Tying knots in a rope causes bends and loops that place uneven strain on the fibers. That can reduce the strength of the rope and decrease its breaking strength. Also, the effects that knots and splices have on a rope vary according to the condition of the rope and the nature of the knot or splice. For instance, knots such as the square knot that create tight bends weaken a rope more than knots with wide bends such as the timber hitch and bowline.

This list shows the approximate percentage of strength left in a rope tied or spliced in certain ways.

Full strength of dry rope	100 percent
Eye splice	90 percent
Short splice	80 percent
Timber hitch, roundturn, half hitch	65 percent
Bowline, slip knot, clove hitch	60 percent
Square knot, sheet bend	50 percent
Overhand knot	45 percent

The Language of Knots

A little terminology can help you learn how to tie knots and understand their advantages.

running end. The end of the rope that is used to tie a knot. This end is also called the *working end*.

standing part. All of a rope that is not the running end.

overhand loop. Formed when a loop is made so that the running end of the rope is on top of the standing part.

underhand loop. Formed when the running end of the rope is placed under the standing part of the rope.

bight. Formed by doubling back a length of the rope against itself to form a U. The running end of the rope does not cross the standing part. (If that happens, the shape it forms is a loop, not a bight.)

turn. To *take a turn*, wrap the rope once around a spar or a stake. The friction created by the turn can help you control a line that has tension on it, especially if you are letting out line or taking it in.

roundturn. Make a *roundturn* by wrapping the rope once around a spar or stake and then halfway around again so that the running end of the rope is going back toward the standing part. A roundturn creates additional friction for controlling a line under strain.

hitch. A knot that secures a rope to a spar or other stationary object.

dress a knot. To adjust a new knot so that everything is in its place. Dressing a knot ensures that the knot will perform as expected.



Overhand loop



Underhand loop



Bight

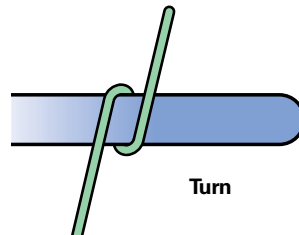

Turn

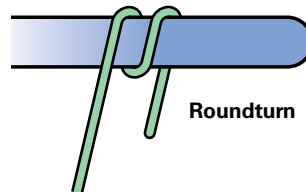

Roundturn

Basic Knots

The knots listed here are important basic knots for use in pioneering and other Scouting activities. These are the knots important to rank advancement. A Scout earning the Pioneering merit badge should be able to tie each of these knots quickly and well.

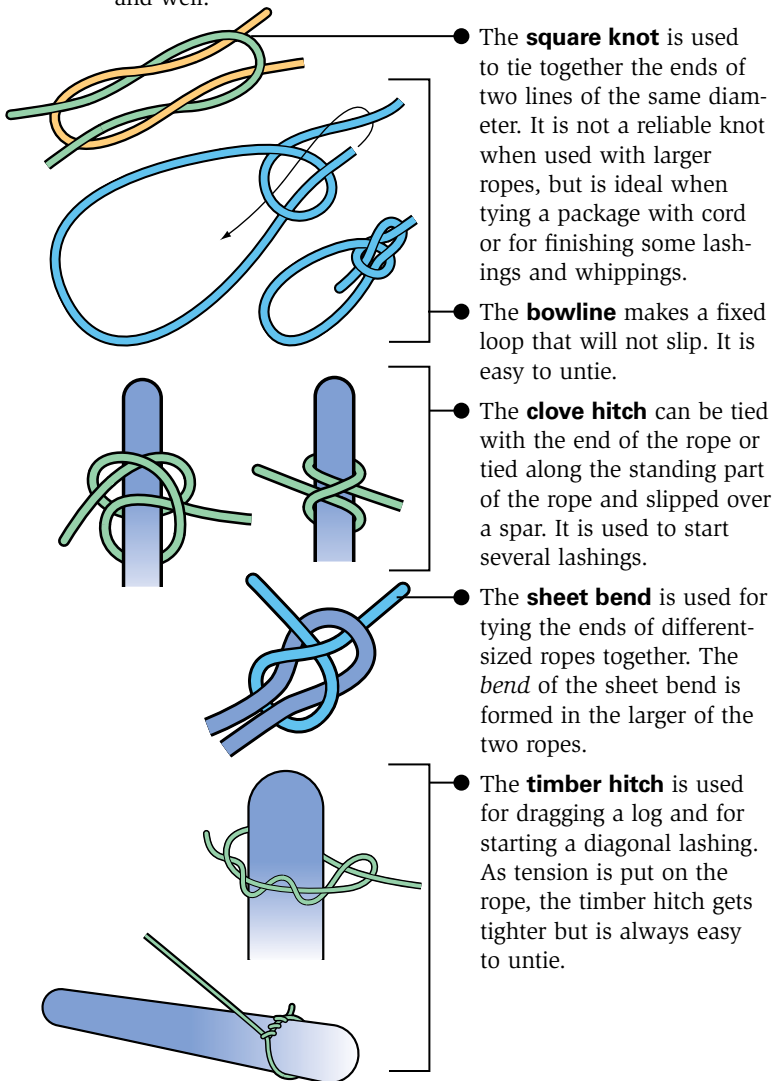

Other Useful Pioneering Knots

For pioneering projects, you will need to add these additional knots to your repertoire.

Roundturn With Two Half Hitches. Use the roundturn with two half hitches to secure the ends of foot ropes and hand ropes for a monkey bridge, and to tie off guylines. If desired, you can secure the running ends with safety knots. This knot is especially useful because it is secure and is easy to tie and untie when adjustments are needed. To make a roundturn, take the running end of the rope around a spar. That will allow you to hold tension on a line while you complete the two half hitches.

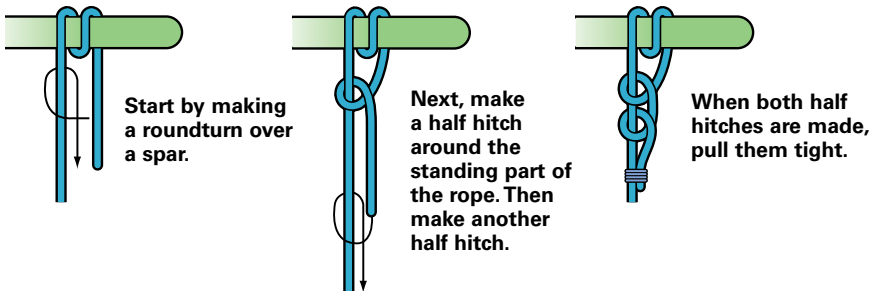

Safety Knot

A safety knot (also known as a *stopper knot*), added to a knot such as the roundturn with two half hitches and the figure eight follow-through, will help keep the free end of the rope from working itself loose. The most effective safety knot goes by several names—*barrel knot*, *one-sided grapevine knot*, and *half a double fisherman's knot*. Form it by loosely looping the tail of the rope twice around the standing part, then running the end up through the two loops thus formed. (This is exactly the same method you use to tie the first portion of the double fisherman's knot, described later in this chapter.) Work out any slack from the safety knot so that it lies snug against the knot it is protecting.

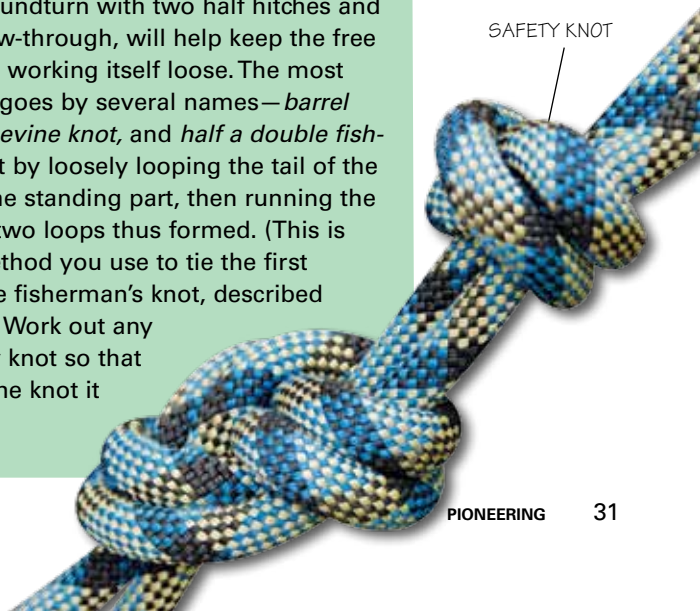

Sheepshank. Use the sheepshank to temporarily shorten a rope's length or to bypass a weak spot in the rope. To begin, take up the slack to shorten the line. This forms two long bights next to each other (1). Secure one bight by forming an overhand loop in the standing part of the rope ahead of the bight and slip it over the end of the bight (2). Form another overhand loop ahead of the second bight and use it to hold that bight in place (3).

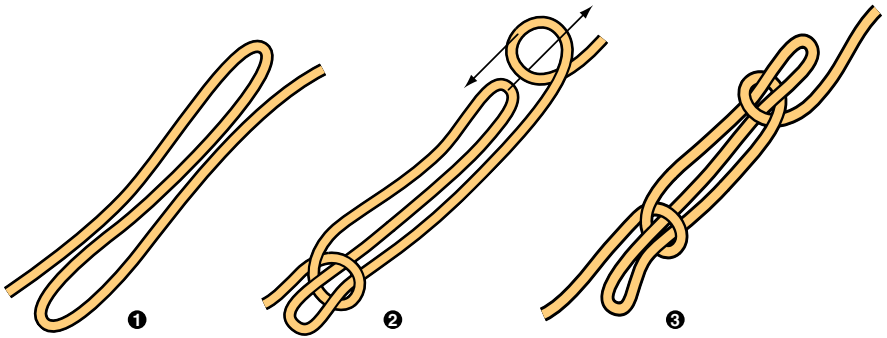

More Pioneering Knots

The following knots are useful in many pioneering projects. Although you do not need to know how to tie them all to meet the requirements for this merit badge, it is a good idea to become familiar with each of them. Knowing these knots will enhance your skill, increase your knowledge, and provide plenty of enjoyment and satisfaction.

Figure Eight on a Bight.

Forming a bight (a bend) in a rope and then tying a figure-eight knot with it results in a loop that will not slip or come loose.

When this knot is tied in the end of a rope, back it up with a safety knot.

Figure Eight Follow-Through.

This is the same knot as the figure eight on a bight, except when it is made, it can be tied around a tree or stake or through an anchor ring. Begin by tying a simple figure-eight knot in a rope. Run the end of the rope around an anchor or through the ring to which you want to attach it (1). Then trace the end of the rope back through the figure-eight knot (the “follow through”) (2). Back it up with a safety knot (3).

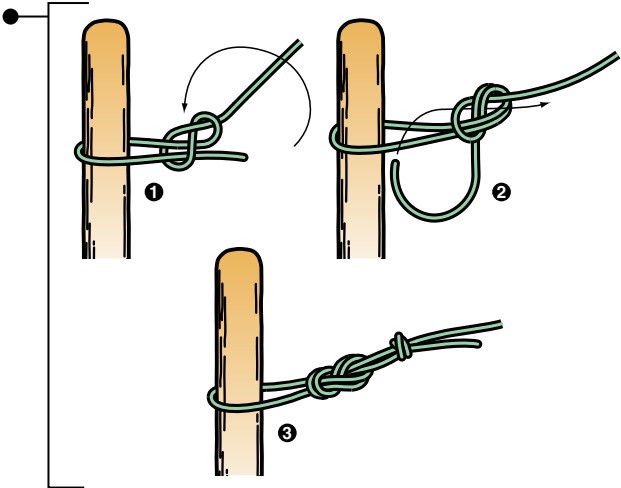
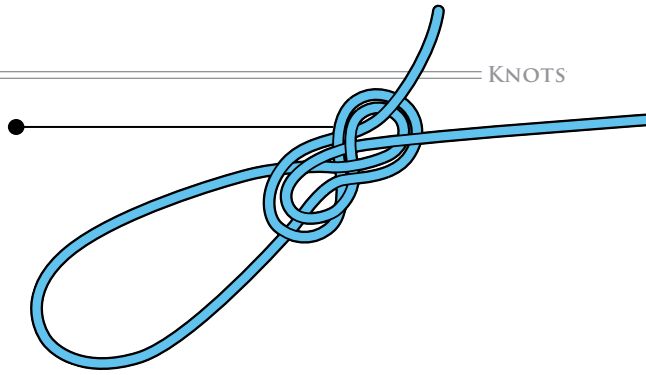
**Double Sheet Bend.**

The double sheet bend has more holding power than a simple sheet bend. It comes in handy when tying together two ropes that vary widely in diameter. It also works well for tying together wet or slippery ropes. Tie it as you would a regular sheet bend, but make two or more turns around the bight.

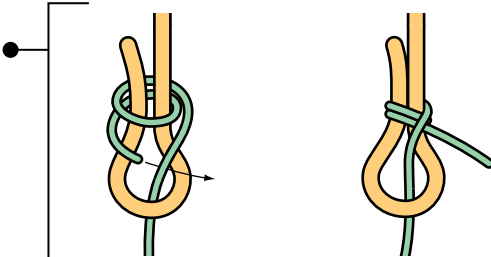

Form a bight in the larger rope. Then wrap the smaller rope around the bight at least twice. Use more wraps if needed to hold it tight.

To finish off the knot, tuck the running end under the standing part of the small rope.

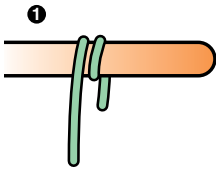

Start the rolling hitch by making a roundturn around a spar.

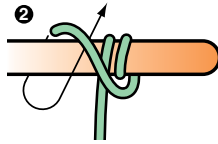

Cross the running end over and make a round turn. Then tuck the end under the turn.

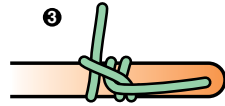

Strain can be applied either parallel or perpendicular to the spar to tighten the hitch.

Rolling Hitch. The rolling hitch has many uses, such as tying a rope to a stake or a spar, or forming a hand or shoulder loop to pull a spar. Essentially it is a clove hitch tied around a spar with an extra turn. Pull can be exerted on a rolling hitch either perpendicular to or parallel with the spar.

It will untie easily. When you need extra gripping power, make additional turns as you tie the hitch.

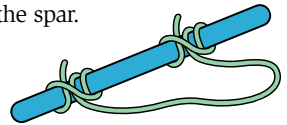

To form shoulder or hand loops for pulling a spar, tie two rolling hitches, one at each end of a short length of rope.

—————
 To tie up horses or anchor canoes on shore, tie a series of the butterfly knot in a picket line, one for each horse or canoe.

Butterfly Knot. This knot creates a fixed loop anywhere along the standing part of a rope. The butterfly is secure, easy to untie, and can withstand tension from any direction. When using a rope to pull a heavy object (such as a log), tie a series of butterfly knots to form loops for each person's hand or shoulder. When climbing a rope, tie a series of the knots to form loops for your hands and feet. This knot also is used when forming a trucker's hitch. (See the "Rope Tackle" section later in this pamphlet.)

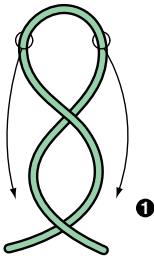

Start a butterfly knot with an overhand loop. Then twist the rope to form a second overhand loop. Drop the upper loop down in back.

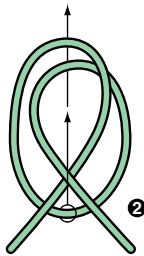

When the upper loop is dropped down, pull it under the two crossed standing parts of the rope. Then pull it up through the top loops to complete the knot.

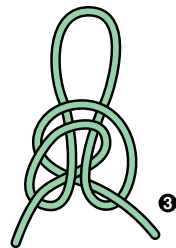

To pull the butterfly knot tight, pull the upper loop while holding the standing parts of the rope at the bottom.

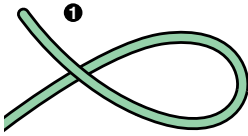

Start a carrick bend by making an overhand loop at the end of one rope.

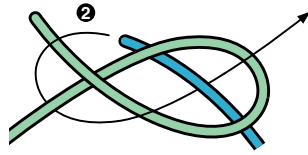

Bring the end of the other rope under the overhand loop. Then complete the knot as shown, weaving over and under as you go.

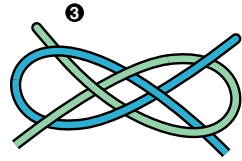

The carrick bend looks symmetrical when first tied and still loose. But pulled tight, it looks quite different.

Carrick Bend. Use this knot for tying together two large-diameter ropes, especially if there will be a heavy strain on the rope. The knot will tighten under strain but won't slip and is usually easy to untie. It works well with wet or slippery ropes. The carrick bend looks symmetrical as it is being tied, but pulling it tight greatly changes its appearance.

The term *carrick* comes from an old word, *carrack*, the name given to certain ships of the 14th, 15th, and 16th centuries.

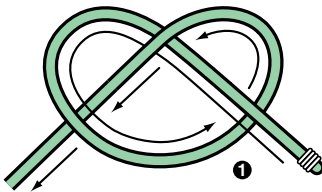

To tie a water knot, begin with a loose overhand knot in one end of the rope or webbing, leaving at least a 6-inch tail.

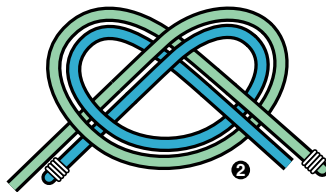

With the other end of the rope or webbing, trace the first end all the way back through the overhand knot, again leaving at least a 6-inch tail. Straighten the knot (dress it), then pull it as tight as possible. Tie safety knots with the remaining tails.

Water Knot. Use this knot to tie together the ends of a piece of rope (such as a flagpole rope) or nylon webbing to make a sling for using with anchoring systems. The water knot won't slip once it has been tightened and is almost impossible to untie—a good thing when used with anchor slings. Back up the water knot with safety knots.

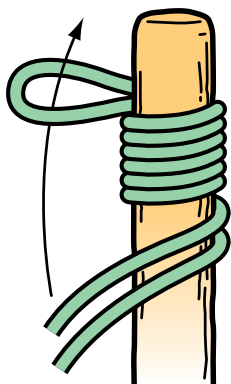

Pipe Hitch. A pipe hitch creates enough friction to keep a rope from slipping and gives considerable grip as you pull on a pipe or spar, or pull a stake or post out of the ground. Tie the pipe hitch with four, five, or six turns; add more turns to get the friction you need. Draw the turns snug as you make them so that you get the full effect of their friction.

To make a pipe hitch, form a bight in the rope and wrap it around the spar. Use at least four wraps, more for more gripping power. Finish the knot by pulling the standing end of the rope through the bight.

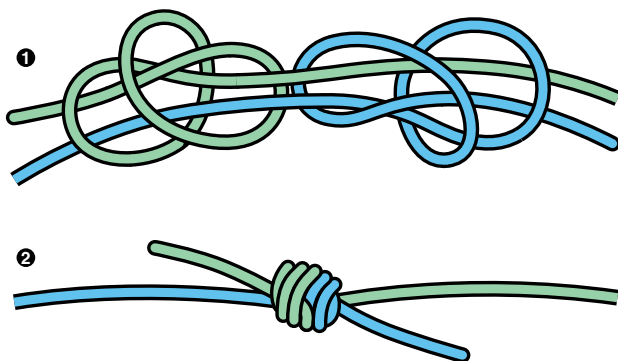

Begin the double fisherman's knot by laying about 2 feet of the ends of two ropes alongside each other, ends opposite. Loosely loop one rope end twice around the other, then thread the end of that rope through the loops. Repeat the process with the second rope end. Carefully tighten the two parts of the knot, then slide them against each other. If they don't fit together neatly, the knot is incorrectly tied.

Double Fisherman's Knot (Grapevine Knot). For tying together the ends of two ropes of equal diameter (especially ropes made of synthetic materials that tend to slip easily), this is the most reliable knot. It also can be used to secure the ends of a rope or cord to form a fixed loop (grommet), which is particularly useful with braided rope that cannot be spliced.

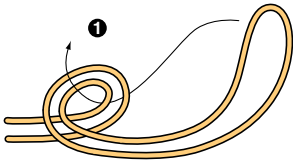

To form a bowline on a bight, first form an overhand loop with a long bight in the rope. Make the bight large enough for the two loops you need.

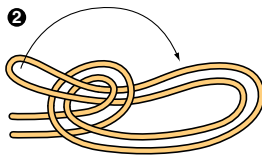

Bring the bight up through the overhand loop.

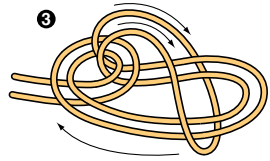

Slip the bight over the bowline loops and up to the standing part of the rope.

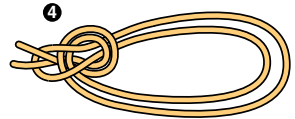

The completed bowline on a bight has two loops that can be adjusted in size before pulling it up tight.

Bowline on a Bight. The bowline on a bight creates two loops anywhere along a rope that you can slip over one or more stakes. It can provide hand and shoulder loops for heavy pulls, and form loops for tying in other lines. Make a bight long enough so that the two loops formed are the sizes you need. Adjust the loop lengths before tightening.

Used by cowboys, the honda forms the loop in a lariat for roping cattle and horses.

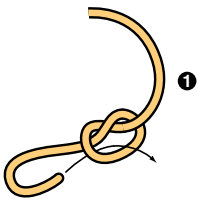

To begin the honda, tie an overhand knot about 12 inches from the running end of the rope, and pass the running end up through the overhand knot from the back.

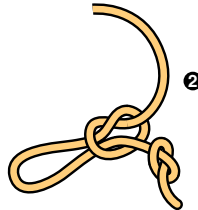

Tie another overhand knot in the running end. Pull the two overhand knots tight to form the fixed honda loop.

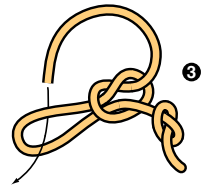

To form a running loop that will tighten as you pull, bring the standing part of the rope through the honda loop.

Honda. The honda knot forms a fixed loop in the end of a rope to put over a stake or spar. It may also form a running loop when you want the knot to tighten as you pull. The knot consists of two overhand knots snugged tightly together to form a fixed loop with a diameter of about 3 inches. The standing part of the rope, passed through the fixed loop, forms the large running loop that will be thrown at a target. Tension on the rope can make the honda almost impossible to untie.

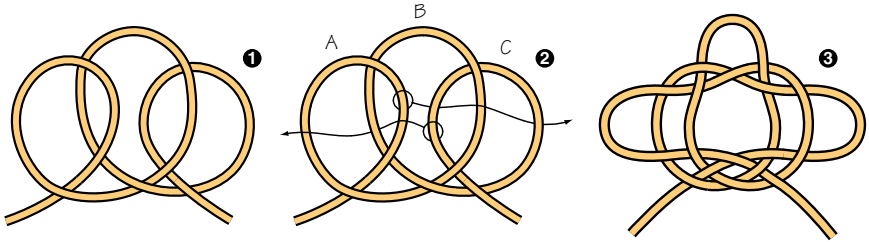

Start the masthead knot by making three overhand loops, laying the second under the first, and the third under the second.

Hold the top of loop B in place while pulling loops A and C over and under as the arrows show.

Add a fourth loop to the finished knot by tying the running ends with a square knot. Secure the ends with safety knots.

Masthead (Jury) Knot. Use this knot when erecting a vertical spar that must be held in position with guylines, or when attaching guylines at the top of a pole. The masthead or jury knot provides four loops for the four guylines. It should be tied with a rope that has a larger diameter than the guylines secured to it. The knot itself creates only three loops. You form the fourth loop by tying the two running ends together with a square knot. Be sure to secure the ends of the square knot with safety knots.

The masthead knot does not cinch tightly around the spar. It must be supported with cleats attached to the spar to prevent it from sliding down.

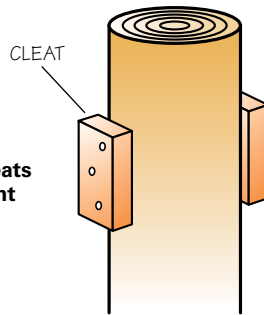

Learning the Ropes

In the days of large sailing ships, a thorough knowledge of handling ropes was important to the safety and success of a voyage. Sailors who had mastered the skills of using knots, splices, ropes, and rigging systems were said to have *learned the ropes*.

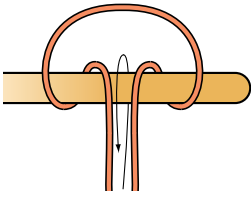

To tie a Prusik, first make a grommet (fixed loop).

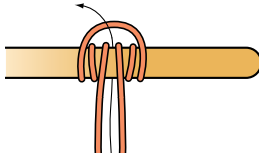

Wrap the grommet around the spar or large rope, making two complete wraps.

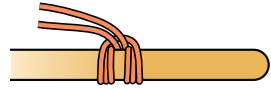

The Prusik can be used on a heavy rope to form a foot- or handhold.

Prusik Knot. Use this knot to make hand and foot loops for climbing another rope or vertical spar, or to make hand and shoulder loops as an aid to hauling a log. A Prusik provides grip and a loop to tie into another line with a sheet bend. It may also serve as a safety brake against back-slipping on a load-lifting line. The Prusik's multiple turns provide friction and create a bend in the standing part of the larger rope, allowing the knot to hold when it bears weight, but to slide on the larger rope when the weight is released.

The Prusik is widely used by mountain climbers to attach a loop (sling) made from a smaller rope to a larger rope to form a hand- or foothold.

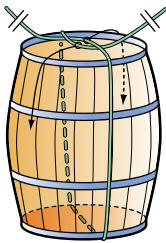

To begin the barrel hitch, stand the barrel centered on the rope and tie an overhand knot at the top of the barrel.

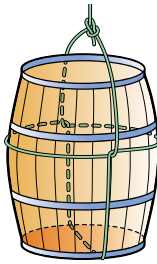

Spread the two sides of the knot down over the sides of the barrel. If a single rope is used for tying and hoisting (as shown here), the running end of the rope is tied into the standing part using a bowline.

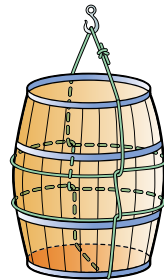

A second overhand knot may be used if needed, and slipped down over the barrel. If a separate rope is used to tie the barrel hitch (as shown here), tie the ends with a square knot and slip it over a hook.

Barrel Hitch. A barrel turned on its side can be secured with a rope sling for hoisting. If a barrel must remain upright while being lifted, use the barrel hitch. Adding a second loop will help stabilize the barrel and keep it upright.

Splicing Rope

Each of the three splices (back, eye, short) begins in a special way. Once a splice has been started, the rest of the process is identical for all three.

Splicing is a means of weaving the strands of any natural-fiber or synthetic three-strand rope to protect a rope end from unraveling, to form a secure loop in a rope end, or to join together two rope ends. Though splices can take longer to form than knots, they have several advantages. They are permanent, reliable, and less bulky than knots, and they reduce a rope's strength much less than knots that serve the same purpose.

Splicing takes practice. It is easiest to learn if you can sit down with someone who can help you master each step of weaving the strands together. Three-strand manila rope with a 1/4-inch diameter works well for learning to splice.



Back Splice

The back splice permanently prevents the end of a rope from unraveling. Because splicing increases the diameter of a rope end more than whipping does, tying knots in back-spliced rope can be more awkward than when using rope protected with whipping.

Step 1—Unlay rope strands about five twists. Bend strand A back between strands B and C and hold it against the standing part of the rope. Allow the bend in strand A to extend upward about an inch.

Step 2—Wrap strand B around the base of the loop formed by strand A.

Step 3—Bring strand C through the loop formed by strand A.

Step 4—Tighten the strands, gently tugging on them to snug them neatly against one another. Doing so makes the *crown knot* symmetrical, with all three strands identically positioned.

Step 5—Pass one strand *over* the strand directly below it and then tuck it *under* the strand alongside that one. (You will need to twist open the lay of the rope to make the tuck.)

Step 6—Continue by passing each strand in turn over the strand directly below it, then tucking it under the strand alongside that one. Repeat this process two more times, going in order with the strands.

After making three tucks with all the strands, cut away half the fibers of each strand. Make a fourth tuck with the reduced strands to taper the splice. Trim the remaining fibers.

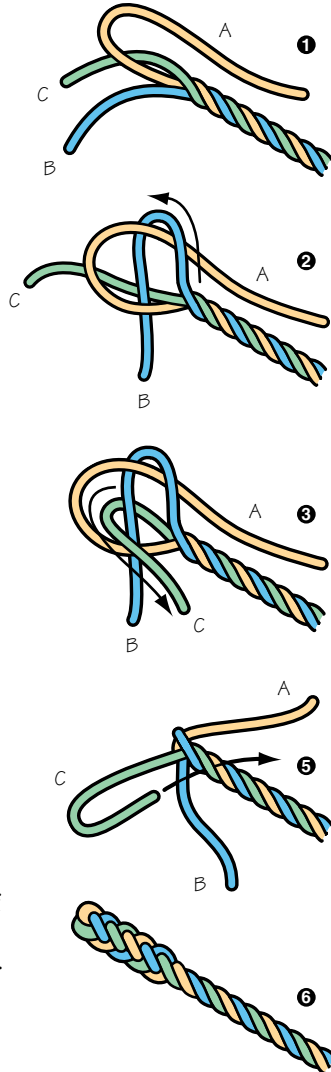

Use the eye splice to splice a rope into an eyebolt at the bow of a canoe, or to splice the throwing line into a ring buoy at the waterfront.

Eye Splice

The eye splice creates a fixed loop at the end of the rope. Use this splice to make a fixed loop in the end of a guyline or to splice a rope into the grommet of a tent or dining fly, or to splice eyes into the ends of a rope to be used as an anchor sling.

Step 1—Use a square knot to tie a piece of whipping cord around the rope about 6 inches from the end. Unlay strands A, B, and C back to the cord and spread them apart. Bend the rope to form an eye of the size you want.

Step 2—Twist open the lay of the rope and tuck center strand B under a strand on the standing part of the rope.

Step 3—Pass strand A over that strand, then tuck strand A under the strand beside it.

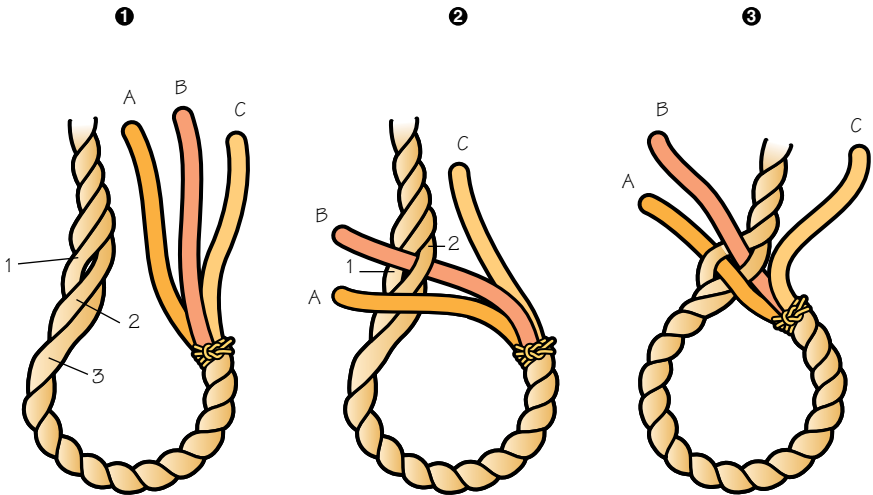

Step 4—Turn the eye over.

Step 5—Find the strand next to the one with strand A tucked under it. Twist open the lay of the rope and tuck the end of strand C beneath that strand. At this point, the eye will be formed and the three strand ends will be symmetrical.

Step 6—Complete the splice as you would a back splice:

- Pass strand A *over* the strand directly below it and then tuck it *under* the strand alongside that one.
- Pass strand B over the strand directly below it, then tuck it under the strand alongside that one.
- Do the same with strand C, going over the strand directly below it and then under the next one.
- Repeat the process twice more, going in order with strands A, B, and then C.
- For a tapered finish, reduce the diameter of the strands and make a fourth tuck.

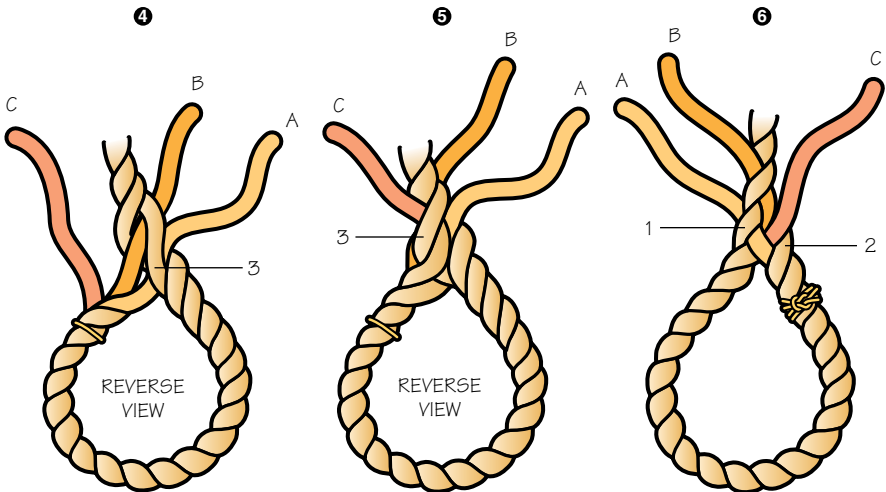

Short Splice

A short splice is used to join two rope ends together. It can be used to join several shorter ropes to form a longer line, or to rejoin a rope that has been cut to remove a damaged section. It may also be used to splice the ends of a short length of rope to form a fixed loop that can be used as an anchor sling (also known as a *grommet* or a *strop*) for anchoring pioneering projects.

Step 1—Unlay the two rope ends 5 to 6 inches. Interlace the strands of one rope end with those of the other. Use whipping cord to secure the strands in place at the point where they meet.

Step 2—Pass strand A *over* the strand directly below it and then tuck it *under* the strand alongside that one. (To make the tuck, first twist open the lay of the rope.)

Step 3—Roll the splice toward you. Pass strand B *over* the strand directly below it, then tuck it under the strand alongside that one. (Strand B will be tucked under the strand lying next to the strand with A tucked under it.)

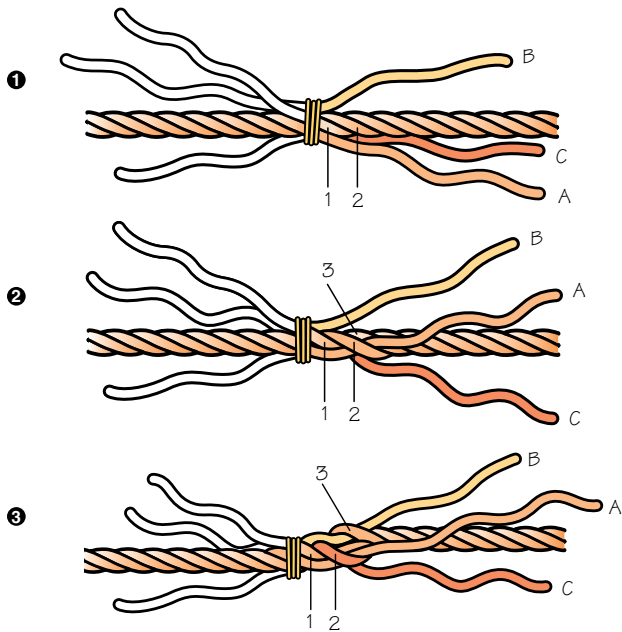

Step 4—Again roll the splice toward you. Pass strand C over the strand directly below it and then under the next one. (Strand C will be tucked under the strand lying next to the strand with B tucked under it.)

Step 5—Continue the splice as you would complete a back splice or an eye splice.

- Pass strand A over the strand directly below it and then tuck it under the strand alongside that one.
- Pass strand B over the strand directly below it, then tuck it under the strand alongside that one.
- Do the same with strand C, going over the strand directly below it and then under the next one.
- Repeat the process twice more, going in order with strands A, B, and then C.
- For a tapered finish, reduce the diameter of the strands and make a fourth tuck.

Step 6—Remove the whipping cord from the splice. With the remaining three strands, complete the splice on the other side by following steps 2 through 5.

Three-strand synthetic rope can be spliced the same way as natural-fiber rope. Since nylon, polypropylene, and other synthetic ropes can be slippery, add extra security by making at least four full tucks with each strand.

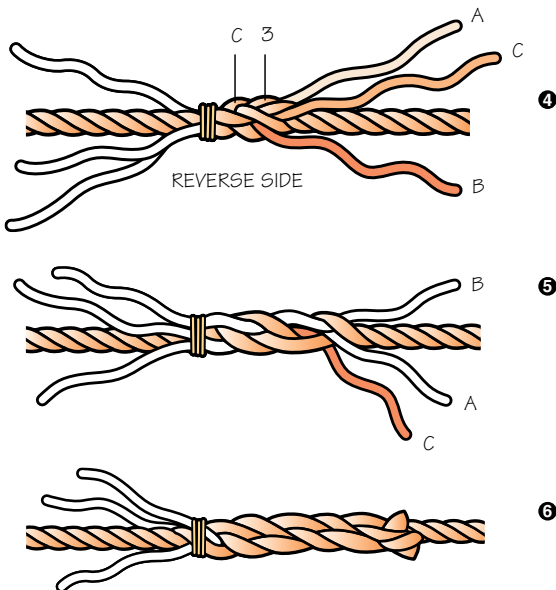

Making Rope

To better understand the structure of rope, make your own. The basic process of making rope consists of twisting fibers to form strands, then twisting the strands together to form rope. You can use either a rope spinner or a ropemaker.

You will need to use a coping saw to make your rope spinner. To make a cutout in a piece of wood, first bore a hole, $\frac{1}{4}$ inch or larger, just inside the shape you want to cut out. Remove the blade of the coping saw, slip the blade through the bored hole, and replace the blade in the saw frame. With the blade thus “inside” the wood, saw along the cutting line. Use the coping saw only under direct supervision of a knowledgeable adult. For more information, see the *Woodwork* merit badge pamphlet.

Making a Rope Spinner

A thousand years ago, American Indians living in what is now Arizona used a *rope spinner* to make rope from the fibers of cactus plants. Using binder twine instead of cactus fibers, Scouts today can make rope the same way. To make a rope spinner, start with a 12-inch piece of 2-by-4-inch construction lumber.



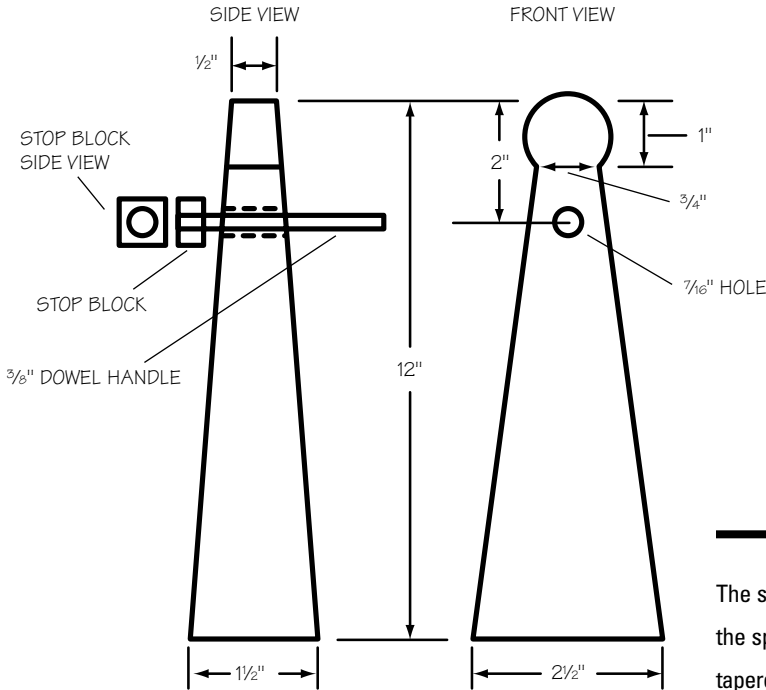

The sides of the spinner are tapered to produce a shape with more weight at the bottom to aid in spinning. The knob at the top is shaped to hold twine and strands in place.

Step 1—Draw the outline of the spinner on the face of the wood, then cut it out using a coping saw.

Step 2—Drill a $\frac{7}{16}$ -inch-diameter hole, positioning it 2 inches from the top of the spinner. The hole will be fitted with the handle.

Step 3—For a spinner handle, use a wooden dowel $\frac{3}{8}$ inch in diameter and about 10 inches long. Make a stop block for the handle from a piece of wood about $\frac{3}{4}$ inch square. Drill a $\frac{3}{8}$ -inch-diameter hole through the center of the block, and glue the dowel end into the hole.

Step 4—Assemble the rope spinner by slipping the handle into the hole in the spinner.

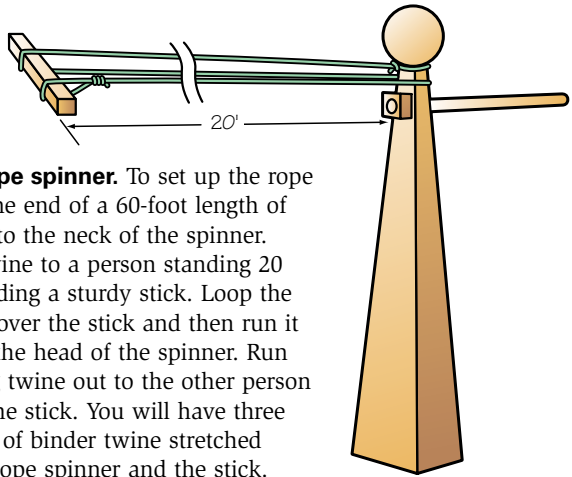

Using the rope spinner. To set up the rope spinner, tie one end of a 60-foot length of binder twine to the neck of the spinner. Extend the twine to a person standing 20 feet away holding a sturdy stick. Loop the binder twine over the stick and then run it back around the head of the spinner. Run the remaining twine out to the other person and tie it to the stick. You will have three equal lengths of binder twine stretched between the rope spinner and the stick.

Spinning a strand. Holding the handle, twirl the spinner clockwise, twisting the three lengths of binder twine into a single strand. A little practice will tell you how tightly to spin the strand.

Spinning a rope. Follow these steps to spin your rope.

Step 1—Leave the newly twisted strand stretched between the spinner and the stick. As the person holding the stick moves forward, loop the strand over the stick and loop it around the neck of the spinner so that you have three lengths of the strand, each about 7 feet long, stretched between the spinner and the stick.

Step 2—Now twirl the spinner *counterclockwise*, twisting the three strands together to form a rope.

Step 3—Temporarily secure each end of the new rope by tying a piece of twine around it. Remove the rope from the stick and the spinner. Whip each end to prevent unraveling, and you will be the proud owner of a rope you made yourself.

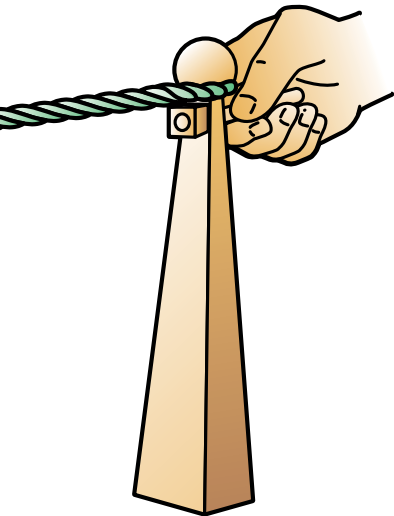

Making a Ropemaker

Farmers a hundred years ago used binder twine with their hay balers. With a little ingenuity, those farmers devised hand-cranked machines to twist the twine into rope. The pieces for the ropemaker are cut from two pieces of $\frac{3}{4}$ -inch-thick plywood about 4 inches wide, one about 20 inches long and another about 15 inches long.

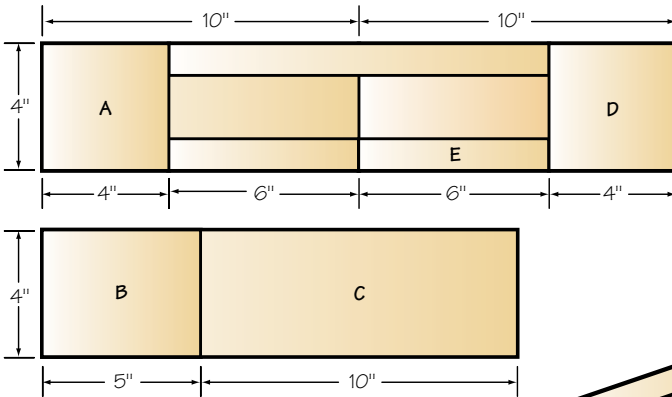

Step 1—Cut piece A, the handle, to shape. (Do not drill the holes yet.)

Step 2—Cut pieces B and C. Glue and screw them together to form the base.

Step 3—Cut piece D, the separator paddle, to the same shape as the handle. (Do not cut out the notches yet.)

Step 4—Mark holes in the handle. First draw a $3\frac{1}{2}$ -inch-diameter circle ($1\frac{3}{4}$ -inch radius) on the handle. The center of this circle should be 2 inches from the end of the handle. The edge of the circle will be $\frac{1}{4}$ inch from each of three edges of the handle. Then, using a protractor, mark the positions of the three holes for the turning hooks. Mark the holes on the circle at 60-degree intervals—the 3 o'clock, 7 o'clock, and 11 o'clock positions.

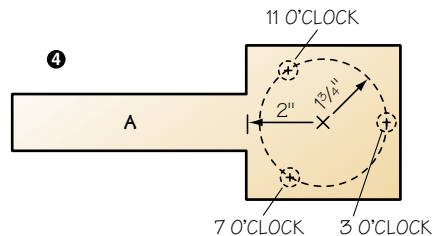
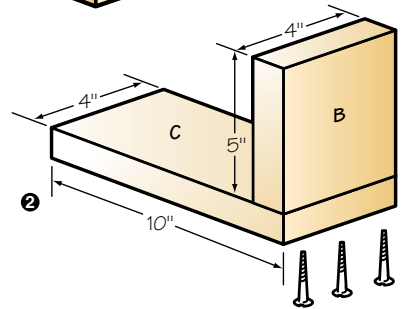
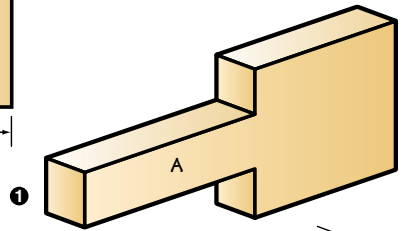

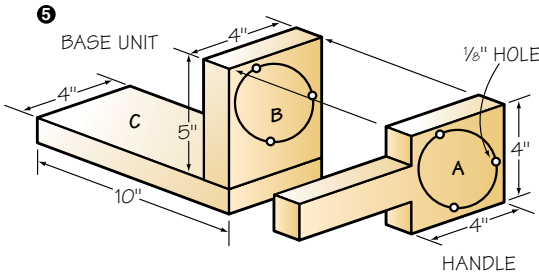

Step 5—Drill the holes. Clamp the handle and the base unit together, as shown. Using a 1/8-inch bit, drill the three holes through both pieces of wood.

Step 6—Make the hooks. Cut three pieces of coat-hanger wire about 8 inches long. Use pliers to make two bends in each wire to form an L-shaped end. Each bend should be about 1 1/2 inches in length.

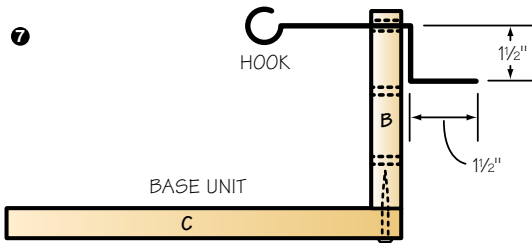

Step 7—Insert the three wires through the holes in the upright piece of the base, then bend the straight end of each wire into a hook.

Step 8—Notch the separator paddle. The separator paddle will be used to keep the strands separated as they are being

twisted into rope. To position the notches, place the handle (A) directly on top of the paddle (D). Push a nail through the holes in the handle and press down on the nail to mark the positions on the paddle. Remove the nail. Sketch the shape of notches that will touch the nail marks on the paddle. Using a coping saw, cut out the notches.

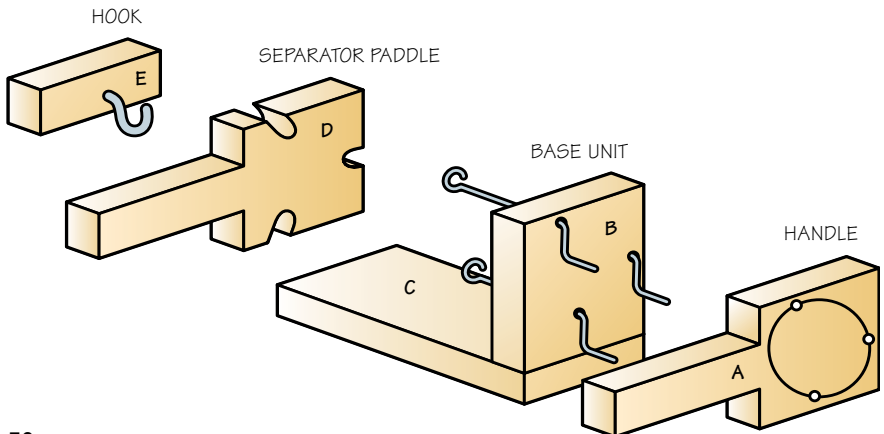

Step 9—Make the end hook. Screw a 3-inch-long screw hook into the center of a piece of wood. (You can use a piece of scrap wood left over from making the handle.)

Practice will help you determine how fast to turn the handle and how quickly to move the separator paddle to make a good piece of rope. Too few turns will produce rope that is loose. Too many turns will produce rope that is twisted too tight and might be hard to use.

Using the ropemaker. Follow these steps to use your ropemaker.

Step 1—Clamp the base unit of the ropemaker to a table or a bench. Tie one end of a 60-foot length of binder twine to one of the turning hooks.

Step 2—Ask another Scout to hold the end hook about 6 feet in front of the base unit. Run the binder twine around the end hook, back to the first turning hook, and then back to the end hook. There will be three strands extending from the first turning hook to the end hook.

Step 3—Continue threading the twine back and forth until you have three lengths of binder twine going from each turning hook to the end hook. Keep enough tension on the end hook to remove any slack from the twine.

Step 4—Ask a third Scout to stand just in front of the end hook and fit the lengths of twine coming off each turning hook into the notches of the separator paddle. As the rope is turned, the Scout holding the separator paddle should move the paddle toward the base unit, making sure the strands do not become fouled.

Step 5—Start turning the handle so that the hooks turn clockwise. As you turn the handle, the binder twine will begin to form into twisted strands, and these strands will also twist to form rope.

Step 6—Temporarily secure each end of the new rope by tying a piece of twine around it. Finish the project by whipping the ends.

Sixty feet of twine will produce a rope 6 feet long.



Anchors and Rope Tackle

Building pioneering projects often requires reliable anchor points for attaching guylines and for both ends of a monkey bridge. You also need secure anchoring when using rope tackle to move or hoist loads.

Anchors

A sturdy tree or a large, immovable rock might be just right for use as an anchor. Otherwise, pioneering stakes driven into the ground can serve as anchors.

Stakes

When nature does not provide a solution, anchors can be constructed using stout pioneering stakes. Ideally, pioneering stakes are made of hardwood. The most common size of stake for the projects shown in this pamphlet is 2 to 3 inches in diameter and about 24 to 30 inches long. After cutting the stake to size, use an ax to shape a point on one end. Bevel the top of the stake to prevent it from mushrooming or splitting when the stake is driven into the ground. Don't use tent pegs as pioneering stakes—they are not long enough or strong enough to make a secure anchor.

Before using an ax, you must earn the Totin' Chip, which grants you the right to carry and use woods tools. See the *Boy Scout Handbook* for details.

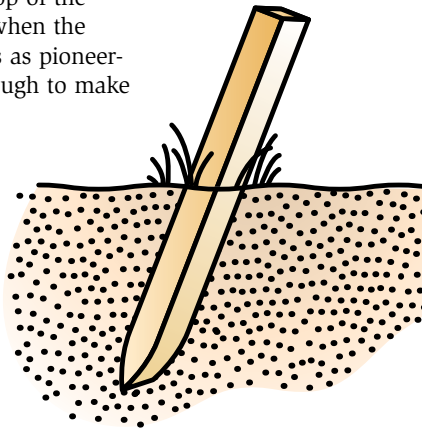

Make a Mallet

Using a sledgehammer to drive a stake into the ground might damage the stake. A better choice is a heavy wooden mallet. You can make your own. Form the head from an 11-inch length of hardwood about 4 inches in diameter. Drill a 1-inch-diameter hole through the head. Shape the mallet handle from a 24-inch length of hardwood; use a sharp knife to whittle one end of the handle to fit the hole in the mallet head.

Saw a slot into the whittled end of the handle. Drive the handle all the way into the hole, then secure the handle in place with a wedge driven into the slot.

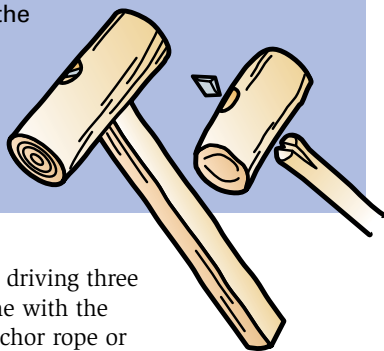

Depending on the load an anchor will bear and the stability of the soil, you can add stakes to the anchor in configurations such as 2-1-1 or 3-2-1.

1-1-1 Anchor

The 1-1-1 anchor is made by driving three stakes in a row directly in line with the direction of the pull of an anchor rope or guyline. Secure a loop of rope between each pair of anchor stakes, then use a stick to twist the rope tight. Push the end of the stick into the ground to keep the rope from unwinding.

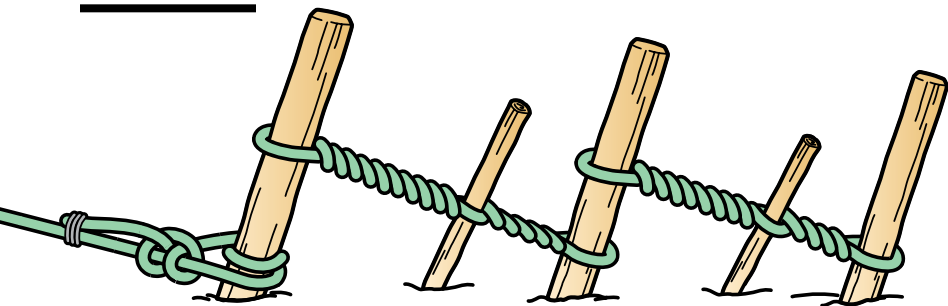

Log and Stake Anchoring System

The log and stake anchoring system relies on a log staked to the ground. Discuss the anchoring needs with your merit badge counselor to determine how large the log needs to be—probably at least 5 feet long and 4 to 6 inches in diameter.

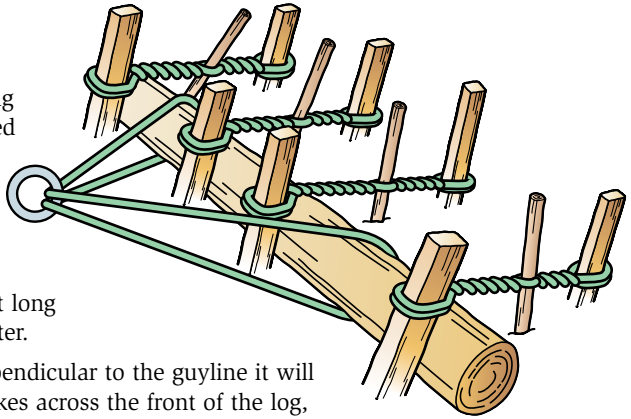

Step 1—Place the log perpendicular to the guyline it will anchor, then drive four stakes across the front of the log, leaning them backward at a 45-degree angle.

Step 2—Position a rope sling around the log. A carabiner (see the *Climbing* merit badge pamphlet) or steel ring secured to the sling will provide a point to tie the guyline.

Step 3—Drive another set of stakes 24 to 36 inches behind the first. Place a loop of rope between each pair of front and back stakes, then tighten by twisting the loop with a stick.

The sling you use should be made of a larger-diameter rope than the guyline it will anchor to avoid creating a weak link in the anchoring system.

Rope Sling

A rope sling (also known as a grommet) is often used as part of an anchoring system. To make a sling from a 10-foot length of 1/2-inch manila or polypropylene rope, splice the ends together with a short splice, or tie them with a water knot or double fisherman's knot. (Use safety knots or lashings to secure the rope ends.)

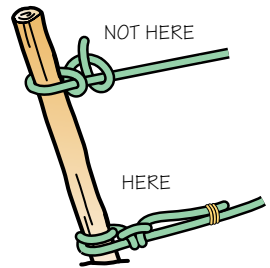
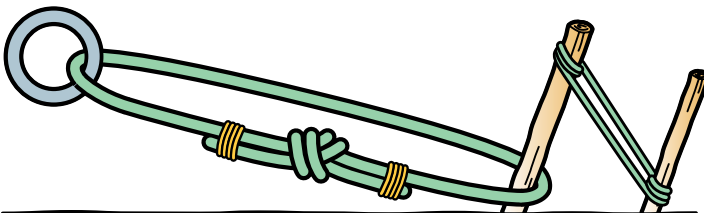

Place an anchor sling or guyline around the stake close to the ground. A line higher on the stake might have enough leverage to pull the stake loose.

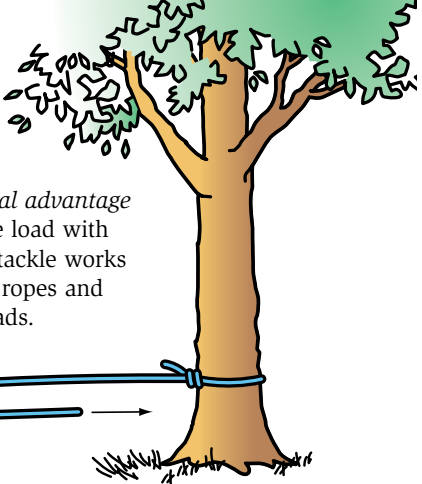

Rope Tackle

Rope tackle creates a *mechanical advantage* that allows you to move a large load with a small amount of force. Rope tackle works on the same principle as using ropes and pulleys for lifting or hauling loads.

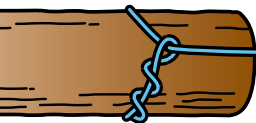

The principles of mechanical advantage can be demonstrated with rope tackle set up to move a log. The type of rope you choose for a rope tackle should have a low stretch factor, such as manila rope. Some synthetic ropes have a slick surface that helps reduce friction, but they might also stretch a lot, lessening the effectiveness of rope tackle. (For applying mechanical advantage to tent and dining fly guylines, parachute cord can be ideal.)

Step 1—Tie one end of your rope to a tree or other secure anchor.

Step 2—Tie one end of a shorter rope around the log with a timber hitch. Form an eye in the other end of the short rope by making an eye splice or by tying a bowline or figure eight on a bight.

Step 3—Pass the running end of the long rope through the eye in the short rope. Pull the slack out of the long rope.

Step 4—Check that the anchor is secure, the timber hitch is well-tied, and the eye in the short rope is correctly formed.

Step 5—Move the log by pulling on the running end of the long line. The mechanical advantage of the system is 2:1; for every 2 feet of rope you pull through the system, the log will move 1 foot. The effort required to move the log is only half what it would be to pull the log with a rope that was not formed into tackle.

Have everyone not involved in moving the log stand well clear of the rope tackle. To reduce friction on the ropes and thus increase the mechanical advantage, snap a carabiner into the loop on the short rope and pass the running end of the long rope through that.

Also known as blocks, pulleys are metal or wooden shells holding wheels over which the rope, known as tackle, can run.

Trucker's Hitch

A useful form of rope tackle is the trucker's hitch. Use it to put tension on lines stretched between two trees, to lift a weight, to tie down and secure your equipment on a trailer or truck, and to tighten guylines on tents and rain flies.



The mechanical advantage created by rope tackle can double the strain placed on a rope. It also can concentrate the tension on loops and knots. Rope moving through a loop causes friction that can generate heat and added strain. Over-loading and heat from friction can damage rope fibers and reduce the efficiency and safety of rope tackle.

Stay within safe working limits by using rope tackle only for loads that can easily be managed with the kind and diameter of rope available. While tackle is in use, keep an eye on all knots and anchors to ensure that they remain secure. Ropes used to make the tackle should be inspected regularly for damaged fibers.

Step 1—Tie one end of the rope to a tent grommet, a tree, or a trailer or truck hook on the far side of a load.

Step 2—Use a butterfly knot to form a loop in the standing part of the rope.

Step 3—Bring the free end of the rope around a stake, a hook on a trailer or truck, or other anchor, and pass the free end of the rope through the loop.

Step 4—Put tension on the rope by pulling the free end, then tie off the rope.

To maintain the tension created by rope tackle (securing a tent guyline, for example), form a bight in the hauling end of the rope and tie it off with a tight half hitch snugged up against the loop formed by the butterfly knot.

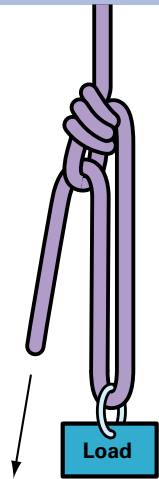

Trucker's hitch



Lashings

Lashing is a way of using rope to securely join spars. Lashings, like knots, have been a part of human knowledge for thousands of years. In fact, the lashings formed today are practically identical to those made by Scouts since Scouting's earliest days.

The Language of Lashings

The following terms will help you understand how to make lashings.

wrap. A wrap is a turn made *around* the two spars to hold the spars tightly together. Usually three wraps are made to form a square lashing. Other lashings might require more wraps.

frap. A frap is a turn made *between* the spars. It goes around the wraps to pull the wraps tighter. Usually two frapping turns are made on a lashing.

spar. A spar is a pole or staff, usually made of wood. Spars are used as the structural members of pioneering projects.

Scouts who have earned First Class rank will be familiar with using square, shear, and diagonal lashings to join two or more poles or staves together.



Square Lashing

Use a square lashing for binding together two spars that are at, or close to, right angles with each other. The spars are *square* with each other; thus the name for the lashing.

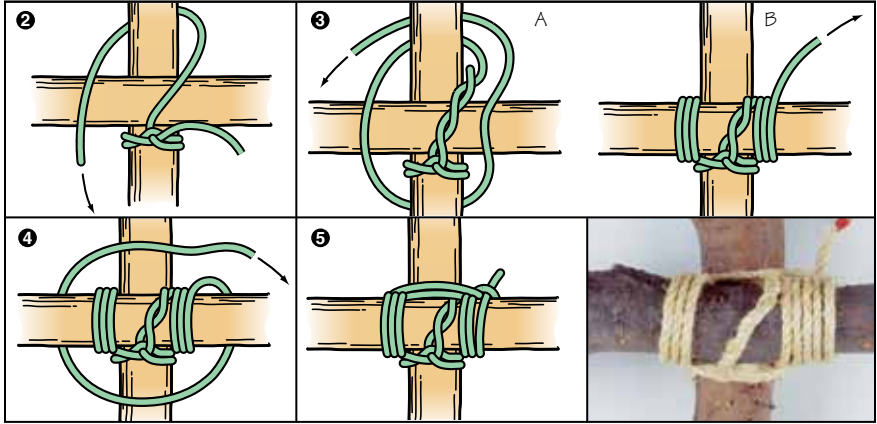

Step 1—Place the spars in position.

Step 2—Tie a clove hitch around the bottom spar near the crosspiece.

Step 3—Make three tight *wraps* around both spars, securing the end of the clove hitch as you would a timber hitch. As you form the wraps, lay the rope on the *outside* of each previous turn around the top spar, and on the *inside* of each previous turn around the bottom spar.

Step 4—Make two *fraps* around the wraps, pulling the rope very tight.

Step 5—Finish with a clove hitch around the top spar.

Rope for Lashing

In most cases, $\frac{1}{4}$ -inch-diameter manila rope is fine for lashing together two spars when the combined diameter of both spars is 6 inches or less. When the combined diameter exceeds 6 inches, use rope that is $\frac{3}{8}$ inch in diameter. To ensure the full strength of a lashing, use enough rope to make the required number of wraps and fraps. Dress the lashing after completing it by wrapping any extra rope around a spar and securing it with an additional clove hitch.

VARIATIONS OF THE SQUARE LASHING

Here are two variations on the basic square lashing.

Modified Square Lashing. Tying a clove hitch to complete a square lashing can be difficult. The modified square lashing eliminates the ending clove hitch.

Step 1—Begin with a clove hitch, but leave a tail of about 12 inches and let it hang free.

Step 2—Complete three wraps and two fraps to form a traditional square lashing, but instead of finishing with a clove hitch, bring up the tail of the rope and tie a square knot in the standing part of the rope.

Japanese Mark II Square Lashing. The Japanese Mark II square lashing is a straightforward approach for lashing two spars together.

Step 1—Begin by folding the lashing rope in half. Place the bend around the vertical spar and beneath the horizontal spar.

Step 2—Working both ends of the rope at the same time, make three wraps around the spars.

Step 3—Bring the rope ends up between the spars in opposite directions to make the frapping turns around the wraps.

Step 4—Pull the frapping turns tight, and complete the lashing by tying the two ends with a square knot.

The advantage of this variation is that you work both ends of the rope at the same time. That can make forming the lashing quicker since each hand has less rope to pull through. The drawback is that it can be more difficult to keep both rope ends pulled tightly than when lashing with a single rope end.

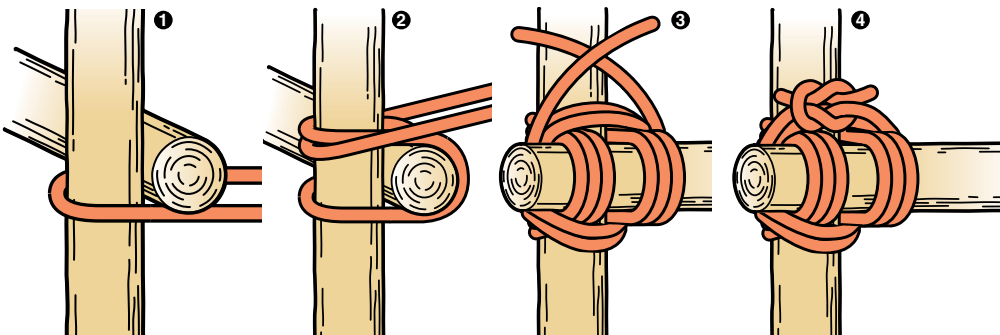
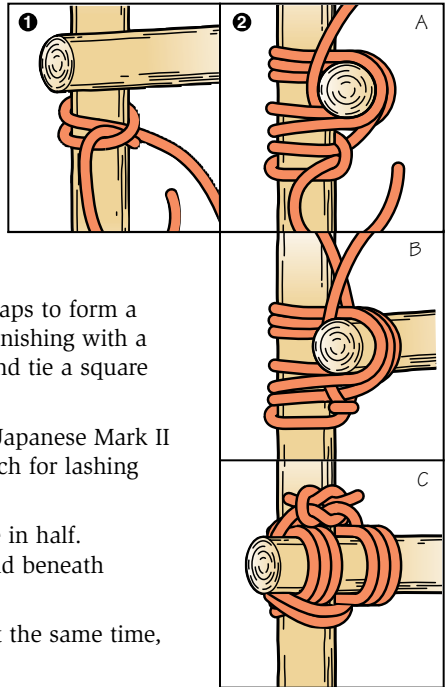

Shear Lashing

Spars secured with a shear lashing can be raised as an A-frame.

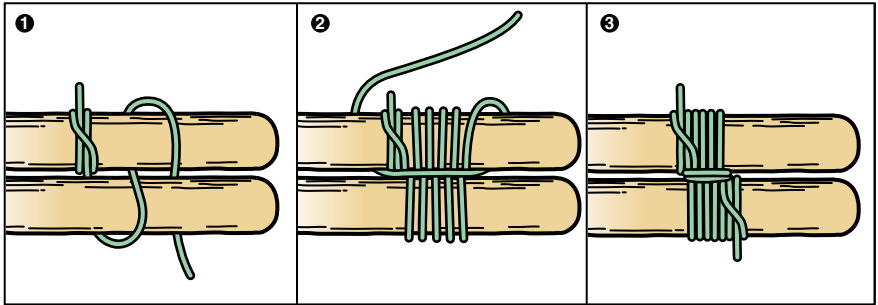

Step 1—Lay two spars side by side and tie a clove hitch to one of them.

Step 2—Make three or four loose wraps around the spars, and then put two loose fraps between them.

Step 3—Finish with a clove hitch around the other spar, then spread the ends of the spars to form the shape you need. Redo the lashing if it is too tight or too loose.



Diagonal Lashing

To bind spars at an angle other than a right angle, use a diagonal lashing.

Step 1—Tie a timber hitch around both spars and pull it snug.

Step 2—Make three tight vertical wraps around the spars, laying the wraps neatly alongside the timber hitch, then make three horizontal wraps across the spars.

Step 3—Cinch down the wraps with two fraps around the lashing, pulling the rope tight.

Step 4—Tie off the rope with a clove hitch.

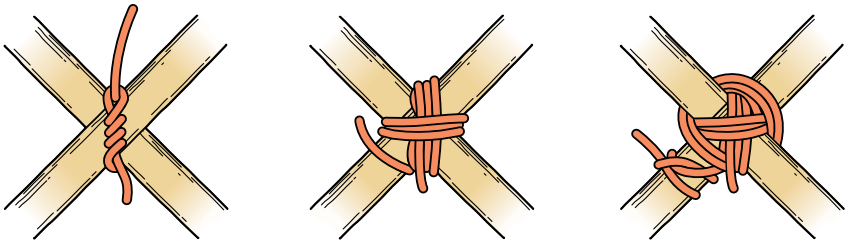

Round Lashing

Round lashings bind two spars side by side.

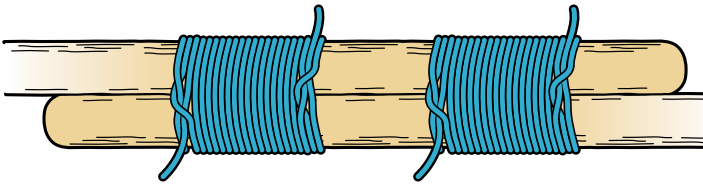

Step 1—Position the spars alongside each other and tie them together with a clove hitch.

Step 2—Make seven or eight very tight, neat wraps around the spars.

Step 3—Finish the lashing with another clove hitch around both spars.

A round lashing has no fraps. The wraps must do all the work, so pull them as tight as you can. Make a second round lashing farther along the spars to keep them from twisting out of line.

When very smooth synthetic rope or very smooth spars are used, the round lashing can be made more secure by adding several additional half hitches to each of the clove hitches.

Other Lashings

A few additional lashings will allow you to build special structures or put the finishing touches on a table, tower, or other project.

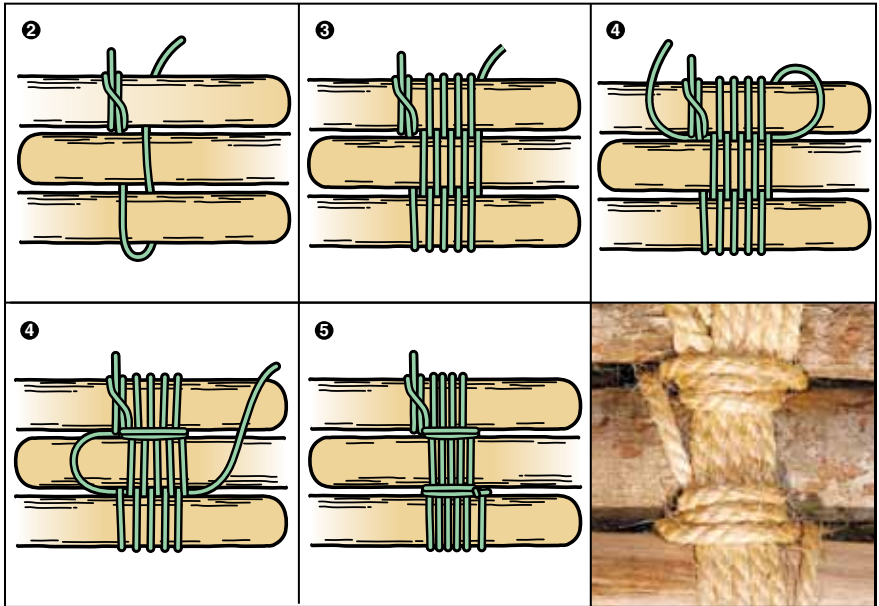

Tripod Lashing. A close relative of the shear lashing, the tripod lashing is the one to use for making a tripod or for joining together the first three poles of a tepee.

Step 1—Lay three poles alongside each other with the top of the center pole pointing the direction opposite that of the outside poles.

Step 2—Tie a clove hitch around one outside pole.

Step 3—Loosely wrap the poles five or six times, laying the turns of rope neatly alongside one another.

Step 4—Make two loose fraps on both sides of the center pole.

Step 5—End with a clove hitch around an outside pole. Spread the legs of the tripod into position. If you have made the wraps or fraps too tight, you may need to start over.

Floor Lashing. The floor lashing will secure the top of a table, the deck of a raft, the floor of a signal tower, or the walkway of a bridge.

Step 1—Lay the poles side by side on top of the *stringers*—the logs or poles on which your platform will rest.

Step 2—Tie a clove hitch around one stringer.

Step 3—Bend the standing part of the rope over the first pole. Pull the bend of rope under the stringer and cast it over the second pole. You may need to lift the end of the pole to get the rope over it.

Step 4—Pull the rope tight, then bend it over the third pole. Continue until all the poles are bound to the stringer.

Step 5—Finish with a clove hitch, then repeat the procedure to lash the other ends of the poles to the other stringer.

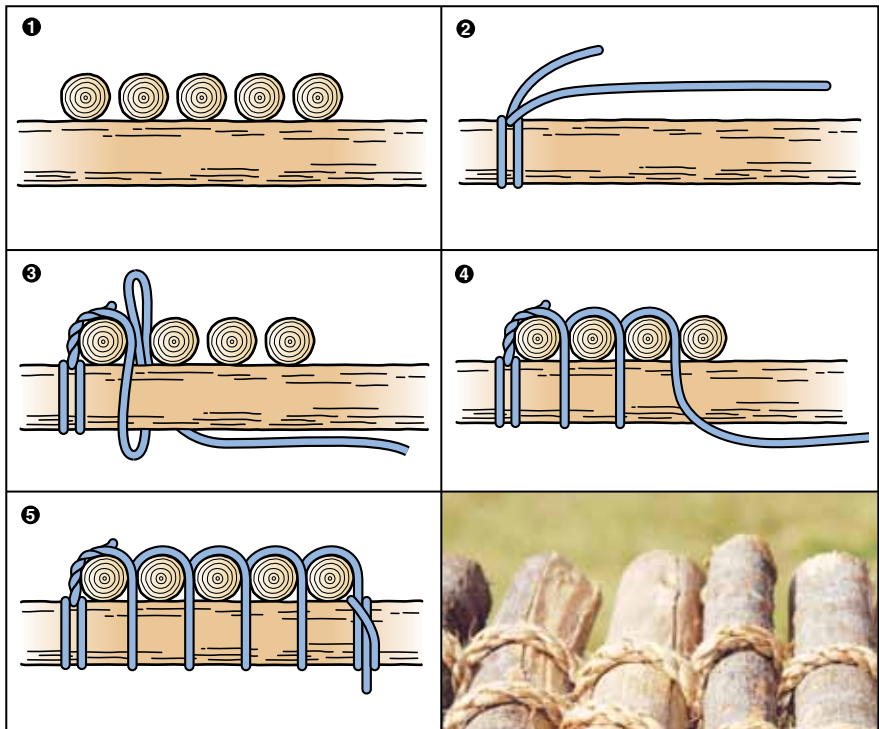

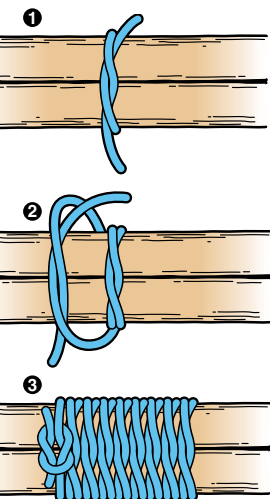

West Country Shear Lashing. Use this lashing in pairs to hold together two spars. The steps for forming it are similar to those for a West Country whipping. The primary difference is that the whipping is used to prevent a rope end from unraveling, while the lashing is used to hold spars together.

Step 1—Lay the spars side by side. Tie the midpoint of the lashing rope around the spars with an overhand knot.

Step 2—Take the two ends of the lashing rope behind the spars and tie another overhand knot.

Step 3—Continue to tie overhand knots, alternating them between the front and back of the spars, until the lashing has been formed.

Always tie each overhand knot the same way (“right over left” or “left over right”) so the knots lie together neatly. Finish the West Country shear lashing with a tight square knot.

If the spars will stay side by side, keep them from twisting out of position by making a second two-spar shear lashing further along the spars.

Two-Spar Shear Lashing. You can use the two-spar shear lashing to extend the length of one spar by lashing another spar to it. This is also a good lashing to use when spar legs will be spread apart to form an A-frame trestle. (See “Lashing Together a Trestle,” later in this section.)

To extend a spar, make two lashings where the spars overlap. The diameter and length of the spars determine the amount of overlap. Place the lashings as far apart as possible to maintain the strength needed.

Step 1—Start with a clove hitch on one spar.

Step 2—Wrap the excess part of the short running end around the standing part of the rope.

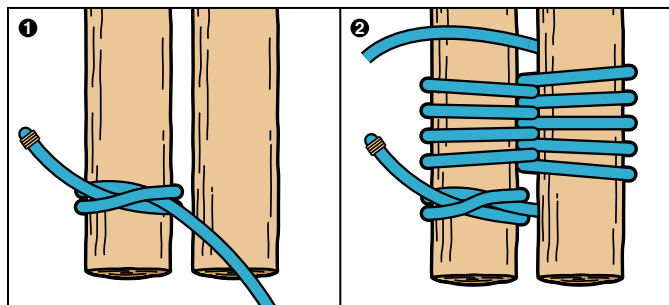

Step 3—Make eight to 10 loose wraps around the spars, then tighten the wraps with two frapping turns between the spars.

Step 4—Finish the lashing by tying a clove hitch on the other spar.

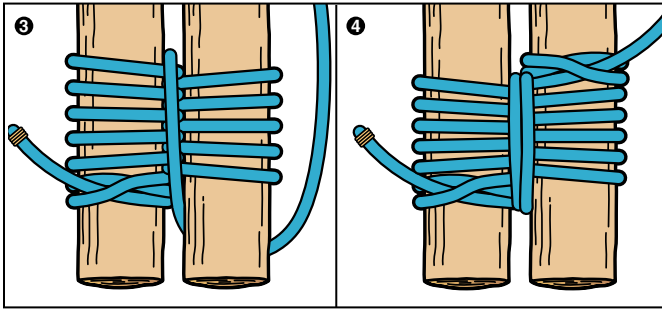

To make an A-frame trestle, place the spars next to each other and form a loose two-spar shear lashing about a foot from the top ends of the spars. Spread apart the other ends to form the A-frame, and tighten the lashing. See “A-Trestle,” later in this section.

Strop Lashing. Sometimes all you need to hold two small spars together are a few wraps with a rope or cord. Finish with a square knot or clove hitch and you have a strop lashing. Essentially it is a shear lashing formed without any fraps. Strop lashings can be used to secure a short stave to a stake, to join walkway sections to a rustic bridge, or to lash the ends of bridge walkways to stakes.

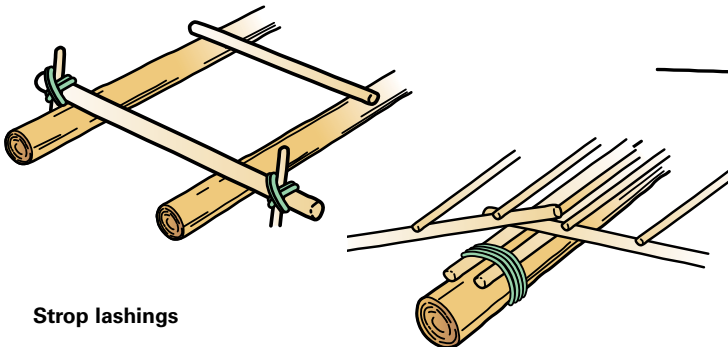

Strop lashings

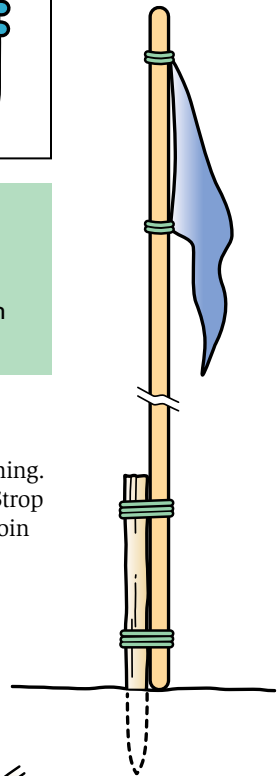

Lashing Together a Trestle

A *trestle* is the main supporting framework for building a rustic tower, bridge, or other pioneering structure. It is made with spars as the primary weight-bearing legs, and braces (including horizontal *ledgers* and *transoms*) providing stability. Three trestle designs are the H-trestle, X-trestle, and A-trestle, each named for the shape of the letter it resembles.

H-Trestle

H-trestles are used in tower designs and for certain bridges. All of the lashings on an H-trestle are square lashings except for the diagonal lashing used to secure the cross braces to one another. Here is how to build an H-trestle.

Step 1—Lay the two legs on the ground with the butt ends (the larger-diameter ends) of the spars at the same end and even with one another. Secure the horizontal ledgers in place with square lashings.

Step 2—Add the cross braces. The cross braces (spars usually 2 inches in diameter) are lashed to the legs in a particular sequence.

- Position one cross brace so that it is on the side of the spars opposite the ledgers. (It might help to flip the trestle over.) Lash the cross brace to the spars with square lashings.

- Position the second cross brace so that one end is on the same side of the spars as the ledgers, but the other end is on the opposite side. Lash the second cross brace to the spars with square lashings. There will be a slight gap between the cross braces where they cross one another.

Step 3—Stand the trestle up. Make sure the legs, ledgers, and cross braces are all properly positioned and secure. If everything looks good, use a diagonal lashing to pull together the two cross braces where they are closest to each other. That will add tremendous stability to the trestle and complete the structure. If adjustments must be made, lay the trestle down and get everything in order before making the diagonal lashing.

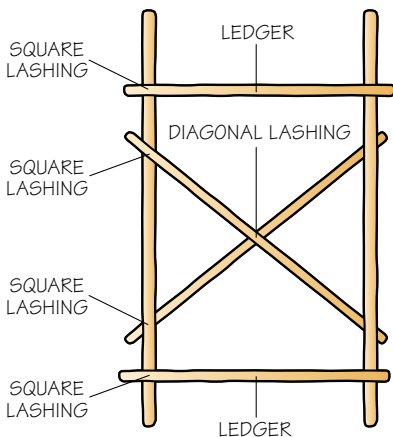

The triangle shapes formed by lashing together spars and braces are among the most basic ways to keep a structure from wobbling.

X-Trestle

Two X-trestles provide the standards at each end of a monkey bridge. Here is how to build an X-trestle.

Step 1—Lay the two legs on the ground side by side with the butt ends (the larger-diameter ends) of the spars at the same end and even with one another. With a loose shear lashing, secure them at the halfway point of their length.

Step 2—Form the X by spreading apart the butt ends of the spars.

Step 3—Create stability by lashing a horizontal ledger in place with square lashings.

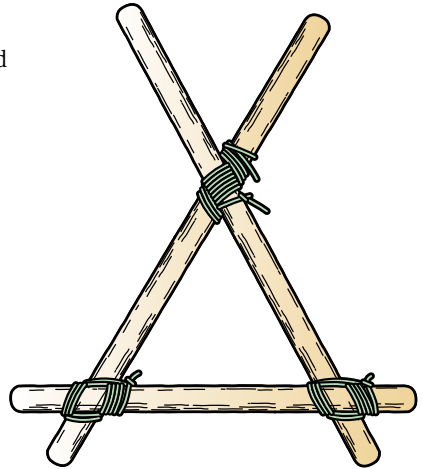

A-Trestle

This design forms an A-shaped trestle that can be used for a variety of bridge plans. Here is how to build an A-trestle.

Step 1—Lay the two legs on the ground side by side with the butt ends (the larger-diameter ends) of the spars at the same end and even with one another. Form a loose shear lashing a foot from the narrower ends of the spars.

Step 2—Spread apart the butt ends of the spars to form the A shape.

Step 3—Use square lashings to add two ledgers (bottom ledger and top transom) to the legs.

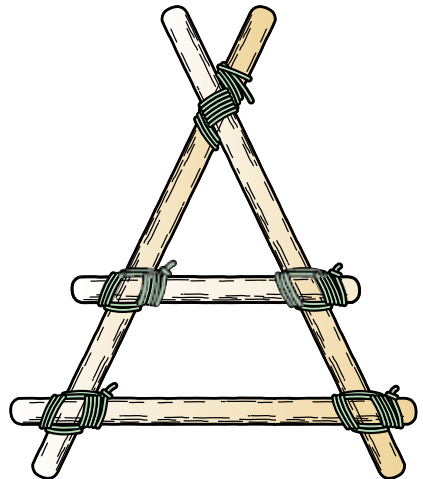



Pioneering Projects

Build a signal tower? You bet. Rig a monkey bridge to cross a stream? There is no better way to spend the day. Lash together a table for your patrol campsite? Perfect.

Project construction brings together all the skills of pioneering. You will need to make a plan, create a design, and develop a list of materials. When everything is ready and you have your counselor's approval, you can use your best skills for making lashings and tying knots. Before long you will have a structure that you'll be glad to call your own.

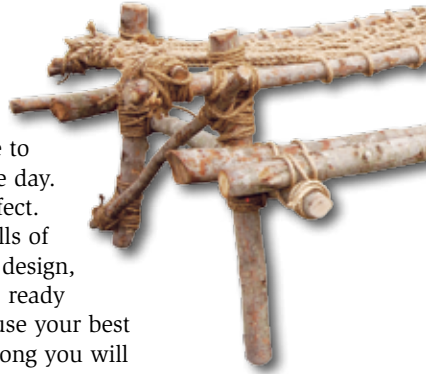

Building Scale Models

With straight sticks and strong string you can lash together models of any rustic structure. A signal tower could be only 2 feet high. A bridge might have a span of just 24 inches but be perfect in every detail. Build your models as authentic as you can, using the correct knots and lashings. When you have the chance to build the real thing, you will know just what to do.

A scale of 1 inch = 1 foot is a good standard for most models. It will mean, for example, that the model of a 24-foot bridge will be 24 inches long. Models built to this scale are easy to manage and large enough to show all the details.

For a permanent model, consider building on a piece of plywood. You could even use plastic foam shaped and painted to represent terrain features—the banks of a stream, for instance. See the *Model Design and Building* merit badge pamphlet for more information on model building.

For “spars,” you may be able to get permission from a landowner to cut lengths of willows or other straight, durable branches. Dowels from building supply stores are useful, too. Strong cotton string or flax cord can be used to make lashings and anchors.



SCALE-MODEL MONKEY BRIDGE

Here is a simple plan for building a scale model of a monkey bridge.

Materials Needed

- 4 ¼-inch (or ⅜-inch) dowels, 12 inches long, for spars
- 2 ¼-inch (or ⅜-inch) dowels, 4 inches long, for crosspieces (ledgers)
- Cotton string or flax cord for lashings (4 strings of about 18 inches each)
- 1 4-foot cord for foot rope
- 2 4-foot cords for hand ropes
- 7 9-inch cords for stringer ropes
- 4 strings for guylines
- 10 toothpicks for stakes (three for each 1-1-1 anchor, four for guylines)
- 2 fabric scraps to use as rope pads
- Block of heavy plastic foam for the base
- Ruler

Step 1—Build two X-trestles. For the spars of each trestle, use two $\frac{1}{4}$ -inch (or $\frac{3}{8}$ -inch) wooden dowels, 12 inches long. Lash them together 5 inches from the top with a shear lashing. Spread the spars apart. Place a 4-inch crosspiece on each trestle, 2 inches from the bottom ends of the long spars, and lash the crosspieces in place using square lashings.

Step 2—Lay out the foot rope and the two hand ropes parallel to each other and about 4 inches apart. Tie a 9-inch-long stringer rope to the midpoint of one hand rope. Make a roundturn with the stringer rope around the foot rope, then tie the running end to the other hand rope. Repeat with the other stringer ropes at 3-inch intervals along the middle 20 inches of the hand and foot ropes. (Leave both ends of the foot and hand ropes free—not joined by stringers. The ends will be secured to anchors.)

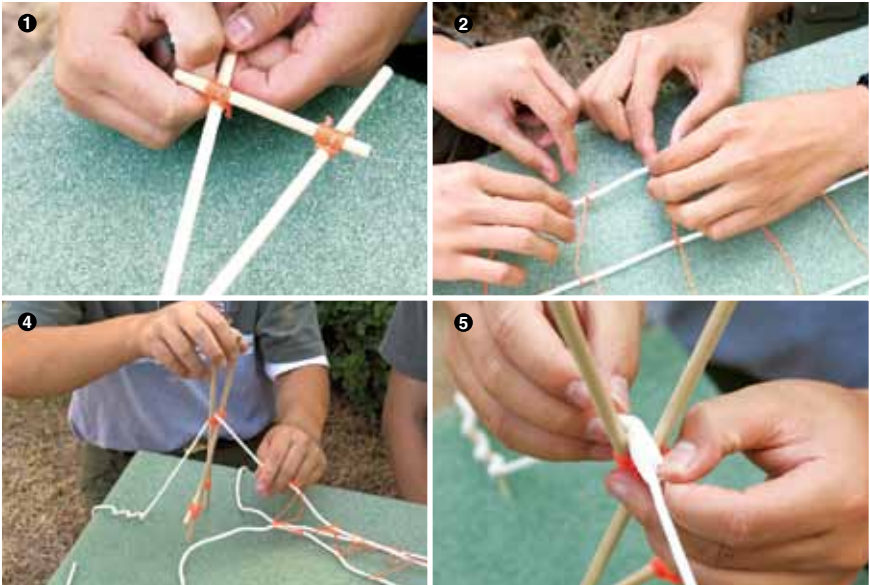

Step 3—Make a 1-1-1 anchor at each end of the bridge. Drive the stakes (toothpicks) into the base so they are aligned with the bridge.

Step 4—Secure the rope assembly temporarily to the anchors. Raise the X-trestles into position. Tie guylines to the trestles and anchor the lines at a 45-degree angle from the direction of the foot rope.

Step 5—Make a pad by folding over a scrap of fabric. Place the pad above the shear lashing of one X-trestle and position the foot rope on the pad. Do the same for the second trestle.

Step 6—Retie each end of the foot rope to its anchor with a roundturn and two half hitches. Tighten the rope to lift the foot rope into position.

Step 7—Secure the hand ropes by forming clove hitches and tightening them near the tops of the X-trestle spars. Anchor the running ends of the hand ropes to stakes (toothpicks) in line with the hand ropes or attached to the 1-1-1 anchor also used to tie the foot rope.

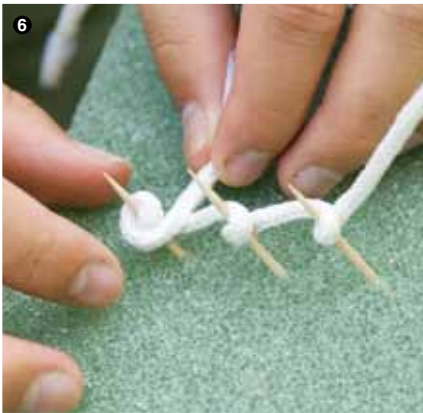

Step 8—Adjust the tightness of all of the ropes and check the knots and lashings to ensure that everything is in order.

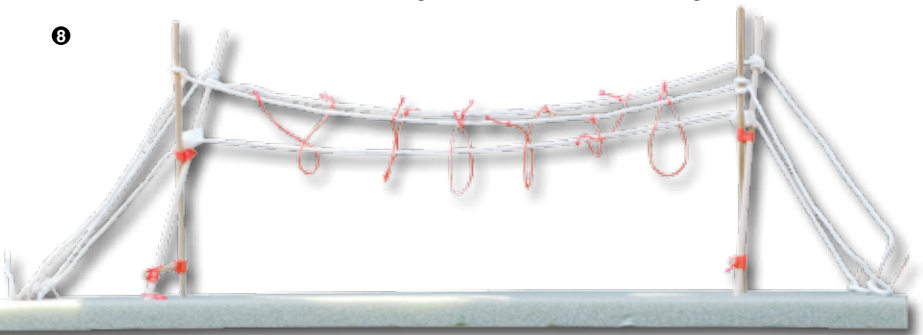

Building a scale model allows you to see firsthand the mechanics of a pioneering project but in a less demanding and less physically challenging setting.

Pioneering Kit

A troop, a district, or a council camp might want to assemble a pioneering kit that contains the ropes and spars needed for a variety of pioneering projects. The materials in the kit can be used at Scouting events, reused many times and replaced as necessary, then neatly stored until the next time they are needed.

Rope can be purchased in spools of 600 feet or more. Manila rope $\frac{1}{4}$ inch in diameter is ideal for most pioneering projects. Cut the rope into lengths of 10, 15, 20, 30, and 50 feet. Whip the ends of each length to help prevent fraying or unraveling. For easy identification, color code the rope lengths by dipping the ends in paint of various colors.

Spars are available from various sources including lumberyards and farm supply stores. Sometimes they can be harvested during timber-thinning operations at Scout camps or on private tree farms. Remove the bark to limit damage from insects and to provide a good surface for securing lashings. As with ropes, spars can be painted on the ends to color-code their lengths.



Treat spars with care so they can be reused and will last a long time. When spars are not in use, store them in a dry, sheltered, and well-ventilated area. Keep the spars off the ground by stacking them on top of several perpendicular logs or timbers.

A typical pioneering kit contains the following spars:

Quantity	Butt Diameter	Length
50	2 to 2½ inches	2 feet
30	2 to 2½ inches	3 feet
20	2 to 2½ inches	3½ feet
15	2 inches	4 feet
10	3 inches	4 feet
10	2 to 2½ inches	6 feet
8	3 inches	6 feet
15	2½ inches	8 feet
10	3 inches	8 feet
10	2½ inches	10 feet
20	3½ inches	10 feet
8	4 inches	10 feet
10	3½ inches	12 feet
6	4 inches	12 feet
6	4 inches	14 feet
4	5 inches	14 feet
<i>Rope for bridge handrails:</i>		
8	1½ inches	12 feet



Other Equipment

Besides spars and ropes, your pioneering kit should contain some basic equipment needed for building projects.

- 2 shovels
- 2 wooden mallets
- 1 hand ax
- 1 bow saw
- 4 spools of parachute cord
- 4 boxes of binder twine
- 10 wooden cleats and nails (for use with masthead knot)
- 50 anchor stakes
- Carabiners, steel rings, and/or screw pin shackles
- Tape measure

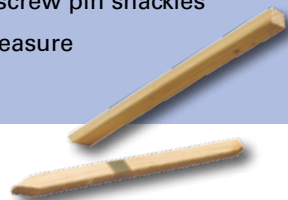

Steps in Building Your Pioneering Project

The pioneering basics—tying knots, making lashings, constructing anchors, and using rope tackle—can be learned and practiced at home and at troop meetings. The projects and structures shown in this pamphlet can usually be constructed with materials available at summer camp or at council camping events.

Step 1—Decide on the type of project you want to build. Consider the equipment, the number of people needed, and the time required to build it.

Step 2—Check the project site. Are there natural anchors (mature trees, large rocks) for securing guylines? If a bridge will cross a stream, how long must the span be, and how high? What safety issues must be addressed before pioneering work can begin?

Step 3—Make a rough sketch of the project. Develop a list of materials that includes all the spars, ropes, and other items you will need.

Step 4—Gather the materials.

Step 5—Review the plans with your crew members and counselor. Perhaps the project can be built as several trestles that can then be lashed together. Several Scouts can be assigned to build each trestle or other subassembly of the project.

Remember, whether you build a project with a group of Scouts or on your own, you will need your counselor's approval before you begin. Your counselor can help you create a rough sketch of the project and make a list of the materials you will need.

When you are ready to begin building, be sure you do so only under the supervision of a Pioneering merit badge counselor.

It is not necessary for your project to be picture perfect, but make it structurally sound. If one or two spars are a bit longer than required, that is fine as long as the lashings are in the proper location for strength and the diameter of the spars will carry the load.

As you build, monitor the progress of the work to make sure everyone involved keeps safety in mind at all times.

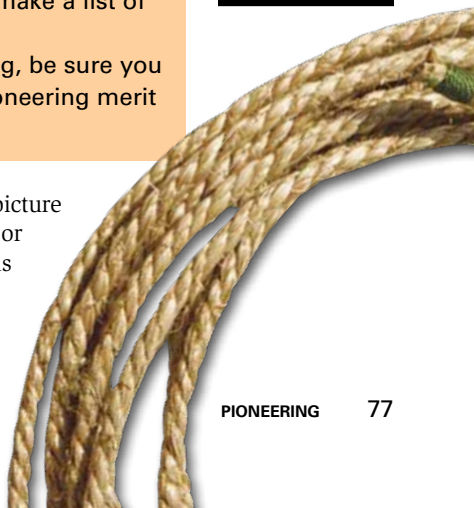

All pioneering projects are temporary in nature. Towers, bridges, and other structures that have been lashed together must be dismantled when they are no longer being used. This is both a matter of safety and a part of BSA's Leave No Trace ethic.

Towers

The double-ladder tower, the traditional signal tower, and the hourglass tower (pyramid tower) present interesting challenges. Each can be constructed as several trestles and then assembled and lifted into position.

DOUBLE-LADDER TOWER

A double-ladder tower requires fewer long spars than do other tower designs. It relies on guylines and a secure anchoring system to remain upright.

Materials Needed

- 4 4-inch-by-14-foot ladder legs
- 10 2-inch-by-3-foot climbing ladder rungs
- 3 2-inch-by-3-foot supporting ladder spreaders
- 2 2-inch-by-3-foot platform handrails
- 2 2½-inch-by-6-foot base spreaders
- 2 2½-inch-by-6-foot platform supporting spars
- 2 2-inch-by-6-foot platform long handrails
- 4 2½-inch-by-10-foot side cross braces
- 2 2½-inch-by-8-foot platform cross braces
- 18 2-inch-by-3½-foot platform floor slats
- 8 stakes for four 1-1 anchors
- 4 ⅜-inch manila or polypropylene guy ropes
- 2 hoisting lines
- 1 brake line

Construct two ladders—a climbing ladder and a supporting ladder.

Step 1—Lay out two pairs of 14-foot spars on the ground for the legs of the ladders. Be sure the butt ends are even at the bottom so the tower will stand up straight. Before you begin any lashing, mark the positions where the spars that will hold the top platform are to be lashed onto the legs—a point about 4 feet from the top ends of the legs.

Step 2—To make the climbing ladder, lash 10 rungs on one pair of legs at about 1-foot intervals. The top rung should be lashed on where you marked the position of the platform, 4 feet from the top. Complete the climbing ladder by lashing the 3-foot handrail in place near the top of the spars.

Step 3—To make the supporting ladder, lash three crosspieces on the other set of legs to serve as the bottom, center, and top spreaders. The top spreader should be lashed at the point marked for the platform, 4 feet from the top. Finish by lashing on a top handrail, as on the climbing ladder.

Lash the ladders together.

Step 1—Position the two ladders on their sides, parallel and approximately 6 feet apart. Make sure the butt ends of the long spars are even. Now lash on a spar (6-foot base spreader) to join together the bottoms of the two ladders.

Step 2—Lash on the platform supporting spar just above the top rung and top spreader on the ladders. Before proceeding, check the measurements from the bottoms of the legs to the platform supporting spar to make sure the legs are equal and the platform is level. Then lash on the top long handrail.

Step 3—Position the two 10-foot side diagonal braces. Use square lashings to lash the ends to the tower legs. Use a diagonal lashing to pull the braces together where they cross and to secure them to each other.

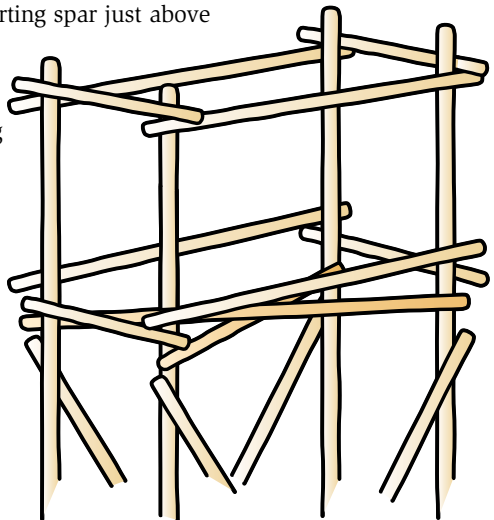

Step 4—With the crew’s help, roll the tower 180 degrees, then lash the spars and braces to the other side of the structure. Begin with the spreader at the base of the ladder legs, then lash on the platform supporting spar, followed by the two diagonal braces. Finish with the top long handrail.

Step 5—Lash on two platform cross braces, diagonally across the legs just under the platform to help the tower resist racking. Use square lashings to lash the cross braces to the legs and a diagonal lashing where they cross.

Step 6—Before standing the tower upright, use a floor lashing to tie the spars (slats) for the tower platform in place.

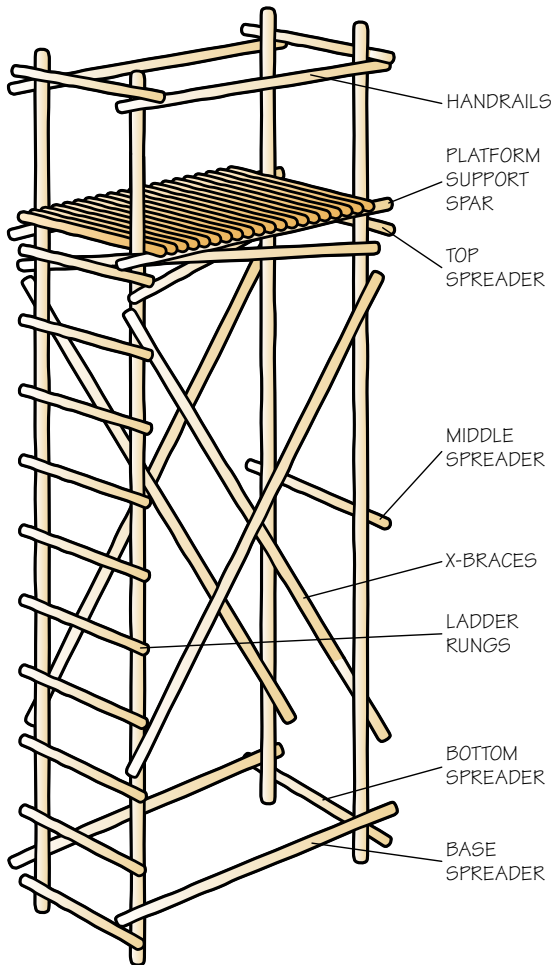

Anchor the tower.

Step 1—Determine where the four anchors for the guylines will be placed to steady the tower. If the tower will use a natural anchor such as a tree or boulder, use a rope sling for attaching the guylines. Use pioneering stakes for all other anchors. At a minimum, you will need well-constructed 1-1 anchors at all four corners.

Step 2—Before hoisting the tower, use a bowline knot or a roundturn and two half hitches to secure the four guylines to the tower legs just above the platform. For the guylines, use at least $\frac{3}{8}$ -inch-diameter manila or polypropylene rope.

Hoist the tower.

Step 1—Tie two hoisting lines to the long spars just above the platform on the side of the tower to be lifted. Tie a brake line on the opposite side to prevent the tower from tipping too far as it is raised.

Step 2—Gather everyone in your crew to assist with the hoisting. Assign one person as a safety officer to stand where he can observe the operation and alert others to any safety concerns. That Scout also can be the signal caller who says when and how fast to pull on the hoisting ropes and when to stop pulling. Post two or more Scouts at each hoisting rope. Assign two or more Scouts to manage the brake rope.

Step 3—When everyone is in position, have the signal caller direct the Scouts on the hoisting ropes to hoist the tower into position. As soon as it up, instruct Scouts to pull out the four guylines and secure them to the anchors with a roundturn and two half hitches, or with a rope tackle (a trucker's hitch is a good choice).

Step 4—Gradually apply tension to the guylines to straighten and stabilize the tower, then tie off the lines.

Test the tower. Before opening the tower to general use, make a test climb while the safety officer and the whole crew observe all lashings and anchors to ensure they are secure.

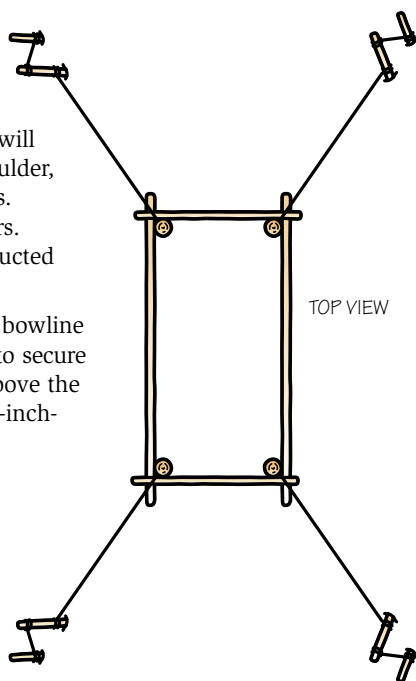

For more on anchors, see the “Anchors and Rope Tackle” chapter.

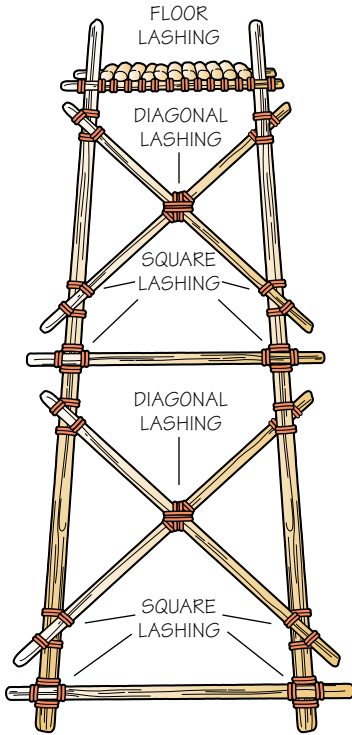

TRADITIONAL SIGNAL TOWER

The square base and narrowing top of a traditional signal tower is a highly stable design.

Step 1—Build two identical trestles. Position the trestles next to each other and lash them together with spars.

Step 2—Raise the tower. Use guy-lines both for pulling the tower upright and for controlling its motion so that it doesn't go too far over. It may be necessary to dig in the butt ends of the vertical spars to keep them in place while the tower is being lifted.



HOURGLASS TOWER

For stability, anchor all towers with guylines.



The hourglass tower, also known as a pyramid tower, uses spars to form triangles that are then lashed together. Building a scale model of the pyramid tower will help you understand how the triangles fit together to form an hourglass shape.

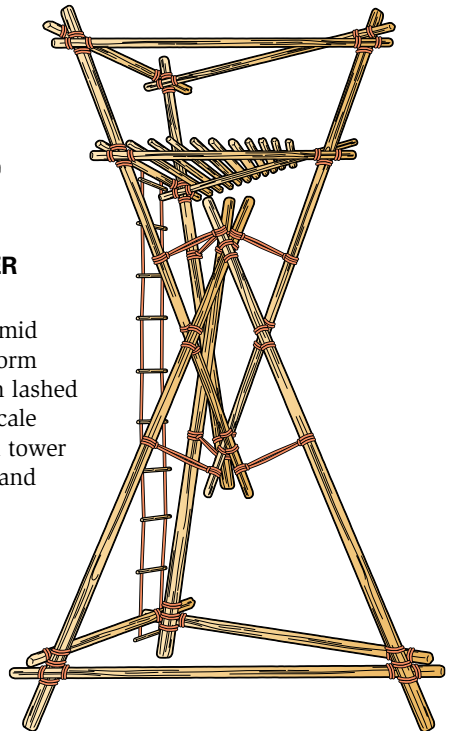

Bridges

Pioneering bridges can be constructed to cross small streams or gullies. Building a bridge for fun and for practice on flat, dry ground can be just as satisfying.

MONKEY BRIDGE

Solid bridges can be built with trestles and walkways. Rope bridges include the monkey bridge.

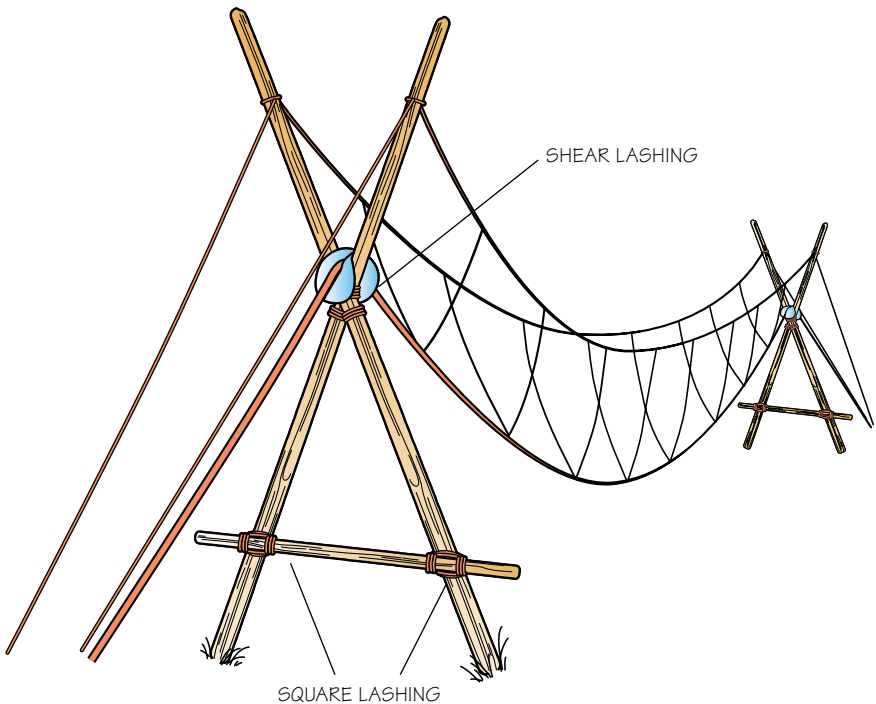

Using 50-foot hand and foot ropes, the maximum span for a bridge is 20 feet. The extra 30 feet of rope allows 15 feet at each end for the proper distance from the X-trestles to the anchors (10 feet), and for making the knots at the anchors (5 feet).

Materials Needed

- 4 12-foot spars, 4 inches diameter at the butt end
- 2 2-inch-by-4-foot crosspieces
- 1 ¾-inch- or 1-inch-diameter foot rope (length of span, plus 30 feet for anchoring)
- 2 ½-inch-diameter hand ropes (length of span, plus 30 feet for anchoring)
- ¼-inch-by-9-foot stringer ropes (divide the length of the bridge span by three to get the number of stringer ropes needed; for example, a 20-foot span will take seven stringer ropes)
- 4 guylines
- 10 stakes (three for each 1-1-1 anchor, four for guylines)
- 2 burlap pads
- 4 lengths of 18-foot rope (for trestle lashings)



Step 1—Begin building two X-trestles by tightly securing two spars, 5 feet from the top, with a shear lashing. Spread the legs apart and place a 4-foot crosspiece on each trestle, 2 feet from the butt ends of the long spars. Tightly secure the crosspiece to the spars using square lashings.



Step 2—Lay out the foot rope and the two hand ropes parallel to each other and about 4 feet apart. Tie a 9-inch-long stringer rope to one hand rope using a double half hitch. Make a round-turn with the stringer rope around the foot rope, then tie the running end to the other hand rope. Repeat with the other stringer ropes at 3-foot intervals along the hand and foot ropes.

Step 3—Make a 1-1-1 anchor at each end of the bridge. Drive the stakes in line with the bridge.

Step 4—Put the rope assembly in place and secure it temporarily to the anchors. Raise the X-trestles straight up and into position, with the butt ends in shallow holes to help prevent shifting. Increase the stability of the trestles by tying them to guylines and anchoring the lines at a 45-degree angle from the direction of the foot rope.

Step 5—Make a pad by folding over a piece of burlap. Place it above the shear lashing of one X-trestle and position the foot rope on the pad. Do the same for the second trestle.

Step 6—Retie each end of the foot rope to its anchor with a roundturn and two half hitches. Tighten the rope to lift the foot rope into position.

Step 7—Secure the hand ropes by forming clove hitches and tightening them to the tops of the X-trestle spars. Anchor the running ends of the hand ropes to stakes driven into the ground in line with the hand ropes or attached to the 1-1-1 anchor also used to tie the foot rope. Using a trucker’s hitch will let you adjust tension on the hand ropes.

Step 8—Tighten all the ropes as much as possible and check the knots and lashings to ensure that everything is in order.



When constructing monkey bridges, observe these safety rules.



- Construct monkey bridges no higher than 5 feet above flat-surfaced ground and no longer than 25 feet.
- Check every rope, especially those carrying a load, each day before using.
- Station Scouts at each end to control access to the bridge. Allow only one person at a time on the bridge. Never allow unaccompanied children on the bridge.
- Shut down the bridge when any repairs are being made. Do not reopen the bridge until the adult leader has approved the repairs.

Any activity on monkey bridges, rope swings, slide-for-life, or similar devices that are located over water must comply with Safe Swim Defense. See the *Guide to Safe Scouting* for more information.

DOUBLE A-FRAME MONKEY BRIDGE

A double A-frame monkey bridge has two additional long spars in each trestle. These can make the bridge more stable and increase the ways to adjust the supports for the hand ropes and foot rope.

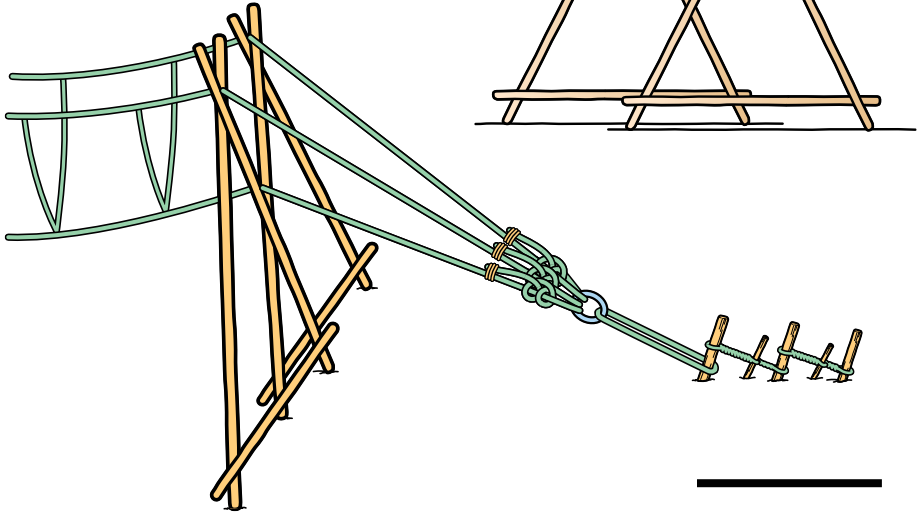

SINGLE-TRESTLE BRIDGE

A single-trestle bridge relies on an H-trestle as a pier in the center of the span. Building the bridge requires lashing together several subassemblies: the trestle, the walkways, and the handrails.

The spars for the walkways and trestle (as listed under “Materials Needed”) will be long enough to span a creek or ravine up to 4 feet deep and 18 feet across. The legs for the trestle should be spars about 3 inches in diameter and 8 to 10 feet long. When choosing these spars, take into account the depth of the creek you are crossing. The distance from the base of the legs to the top ledger (transom) on the trestle should be about a foot higher than the level of the banks of the creek. This will allow the walkways to slant upward. For attaching the handrail, allow an additional 4 feet from the top ledger to the top of the legs.

Make the top ledger of the trestle about 3 inches in diameter since it will carry the weight of the walkways and the person using it. The bottom ledger can be about 2 inches in diameter.

See the “Lashings” section for detailed instructions on how to make an H-trestle. You will find instructions for making a walkway later in this chapter.

Materials Needed

- 2 3-inch-by-8-foot or -10-foot trestle legs
- 1 3-inch-by-4-foot trestle top ledger (transom)
- 1 2-inch-by-4-foot trestle bottom ledger
- 2 2-inch-by-6-foot cross braces
- 4 3-inch-by-10-foot walkway lateral spars
- 12 2-inch-by-3-foot walkway cross spars
- 4 2-inch-by-3½-inch walkway cross spars
- 2 2-inch-by-10-inch-by-10-foot walkway planks
- 4 1½-inch-by-12-foot handrails
- 4 stakes

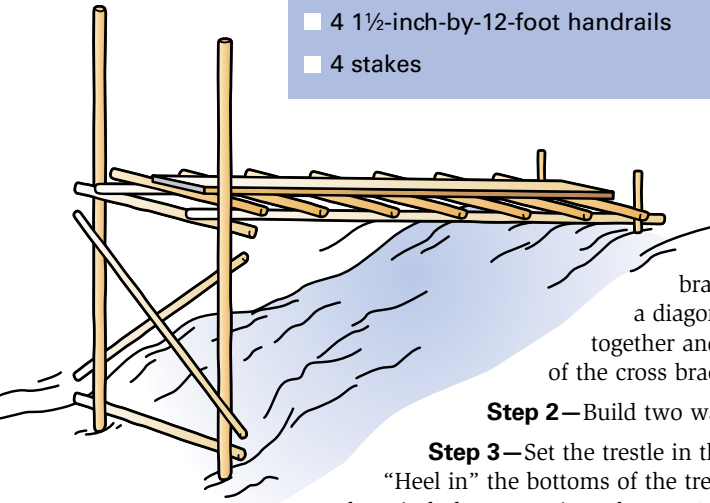

Step 1—Assemble the H-trestle with square lashings to hold the ledgers and the ends of the cross braces to the legs. Use a diagonal lashing to draw together and secure the center of the cross braces.

Step 2—Build two walkways.

Step 3—Set the trestle in the center of the creek. “Heel in” the bottoms of the trestle legs by setting them in holes approximately 4 to 6 inches deep. This will help prevent the trestle from shifting and will also help level the transom spar.

Step 4—Put the walkways in position from both sides and lash each walkway’s underspars to the transom (top ledger) of the trestle. Then drive stakes at the other end of the walkways. Lash the ends of the cross spars on the walkways to the stakes.

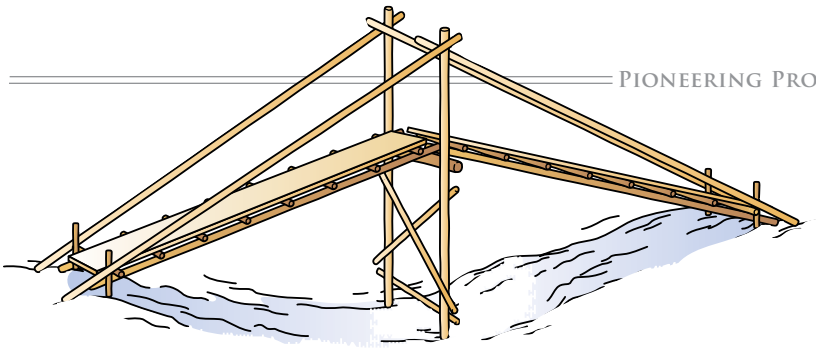

Step 5—To strengthen the structure and as an aid in crossing the bridge, install handrails. The handrails form triangles with the walkway and the trestle leg, increasing the structure's stability. Use strop lashings to lash the handrails to the top of the trestle legs and to the stakes.

SINGLE-LOCK BRIDGE

The single-lock bridge consists of two H-trestles locked together.

Materials Needed

The list of spars shown for this project should build a bridge to span a creek or ravine approximately 4 feet deep and 18 feet from bank to bank.

- 4 3-inch-by-6-foot trestle legs
- 4 2½-inch-by-4-foot trestle ledgers
- 1 3-inch-by-4-foot trestle transom
- 4 2-inch-by-6-foot cross braces
- 4 3-inch-by-10-foot walkway lateral spars
- 12 2-inch-by-3-foot walkway cross spars
- 4 2-inch-by-3½-foot walkway cross spars
- 2 2-inch-by-10-inch-by-10-foot walkway planks
- 4 stakes

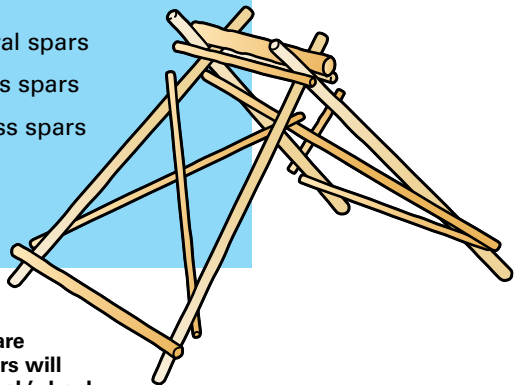

Begin by building the two H-trestles as subassemblies. Adjust the length of the spars for the trestles so that when they are placed in the creek, the tops of the ledgers will be about 1 foot above the level of the creek's banks. This will give a comfortable slant to the walkways.

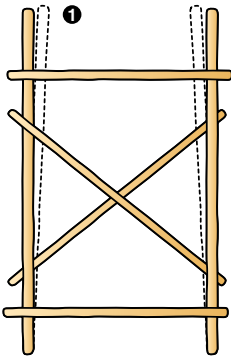

Step 1—Construct the two trestles, making sure that the legs of the second trestle are spaced at the top to fit between and “lock” into the legs of the first.

Step 2—Construct the two walkways. (See “Walkways” later in this section.)

Step 3—Place the trestles over the center of the creek so that the tops of the trestles are interlocked. Lay a 3-inch-diameter transom spar on top of the interlocked trestle legs.

Step 4—Stabilize the structure. Place the bases of the legs in holes 4 to 6 inches deep, leveling the transom spar so that the walkways won’t tilt sideways.

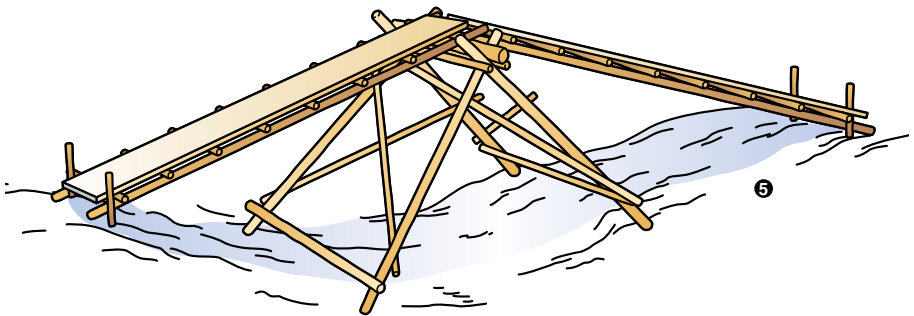

Step 5—Position the walkways. Use strop lashings to lash the underspars on the walkways to the transom spar and to lash the cross spars at the ends of the walkways to the stakes.

SINGLE A-FRAME BRIDGE

The simple design of an A-frame bridge makes it a good choice when time and building materials are in short supply.

Materials Needed

- 2 3-inch-by-12-foot A-frame legs
- 1 2-inch-by-6-foot bottom ledger
- 1 3-inch-by-6-foot transom
- 4 3-inch-by-10-foot walkway lateral spars
- 12 2-inch-by-3-foot walkway cross spars
- 4 2-inch-by-3½-foot walkway cross spars
- 2 2-inch-by-10-inch-by-10-foot walkway planks
- 4 stakes

Step 1—Start this project by measuring the depth of the creek or ravine to be spanned. Add 8 feet to that measurement to get the total height of the legs for the A-frame. For example, to span a creek 4 feet deep, the legs of the A-frame should be 12 feet or longer.

Step 2—Lay out the spars and ledgers for the A-frame trestle. Position the transom (the top ledger) and the spread of the spars so that when completed, the transom will be about a foot higher than the banks of the creek and there will be room from the transom to the top of the A-frame for a person to pass freely along the walkways.

Step 3—Use a shear lashing to lash together the two spars. Make the lashing somewhat loose so that you can spread the spar legs apart to form the shape of an A. As you spread the spar legs, the shear lashing will tighten.

Step 4—Complete the A-frame by lashing the bottom ledger across the legs about a foot from the butt ends of the spars. Then lash the transom spar to support the walkways at the proper height in relation to the banks of the creek.

Step 5—Build two 10-foot walkways. (See “Walkways,” later in this chapter.)

Step 6—Place the A-frame in the center of the creek and heel in the legs in holes about 4 to 6 inches deep. As the legs are being heeled in, level the transom.

Step 7—When the A-frame is upright, position the ends of the walkways on the transom and lash them in place with strop lashings. Finally, use strop lashings to secure the cross spars at the ends of the walkways to stakes driven into the banks of the creek.

Step 8—To ensure that the A-frame won't tip over, use guylines extending from the top of the A-frame to anchors on each bank of the stream.

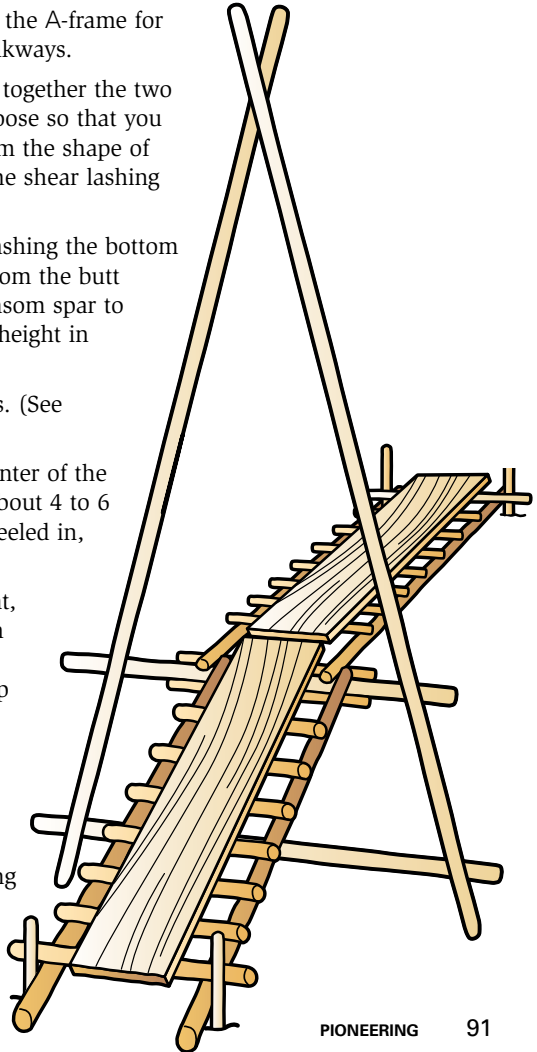

Walkways

Many bridge designs have one or more trestles supporting a walkway. The walkway of a monkey bridge is a rope suspended between the trestles. For most other bridges, you build a solid walkway from spars.

Three of the bridges shown in this pamphlet use walkways constructed from two lateral spars and several cross spars. Planks laid atop the walkways provide easy footing for travelers. In most cases, each bridge has at least two walkways.

If you have no planking material, you can create a travel surface by adding enough cross spars to the basic walkway design to provide travelers with sure footing along the full width of the bridge.

Materials Needed

- 2 3½-inch-by-10-foot lateral spars
- 6 2½-inch-by-3-foot cross spars
- 2 2½-inch-by-3½-foot cross spars
- 1 2-inch-by-10-inch-by-10-foot walkway plank

Step 1—To make a 10-foot section of walkway, select two spars with a butt diameter of about 3½ inches. Be sure the spars sag equally under stress, when you stand on them with the ends supported above the ground. If one spar sags more than the other, it will cause the walkway to slant or twist sideways, making walking difficult.

Step 2—Place one of the longer (3½ inches) cross spars *on top* of the butt ends of the lateral spars and use a strop lashing to secure it. Fit the other longer cross spar *beneath* the other end of the lateral spars and lash it where it will serve as the *underspar*.

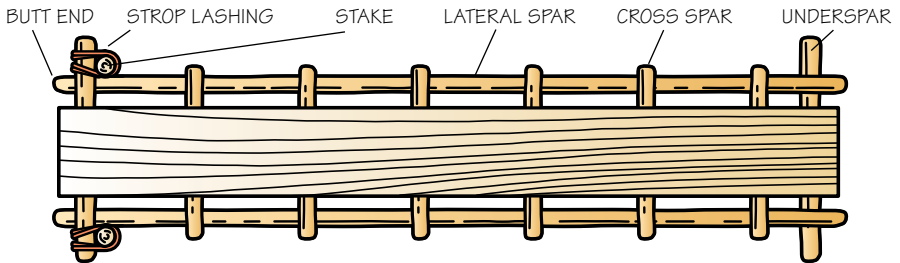

Step 3—Place the shorter (3-foot) cross spars on top of the lateral spars. Space them evenly between the ends of the walkway and use square lashings to attach them to the lateral spars. Since the lashings are intended only to hold the cross spars in position and not to support weight, you can make the lashings with either 1/4-inch rope or parachute cord.

Step 4—Lash the plank for the walking surface in place using strop lashings around the plank and the cross spars. To make a strop lashing, tuck the end of a length of parachute cord or doubled-over binder twine under the cross spar and, pulling out the slack, even up the ends. Bring the ends over the plank and cross them under the cross spar. Wrap them back over the plank and around the cross spar several more times, finishing the lashing with a square knot.

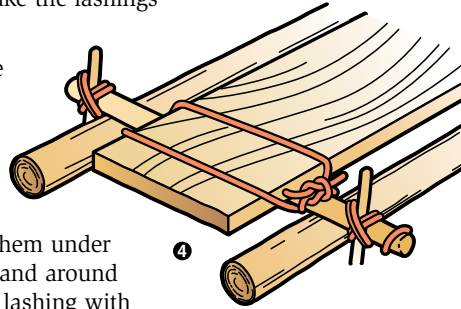

Step 5—After assembling the walkway, place the butt end on the bank of the creek or ravine and position the other end on the trestle. Anchor the butt end by driving stakes next to the first cross spar and using strop lashings to secure the lateral spars to them. The other end of the walkway will rest on the transom spar of the trestle. Use strop lashings to fasten the underspar of each walkway section to the transom.

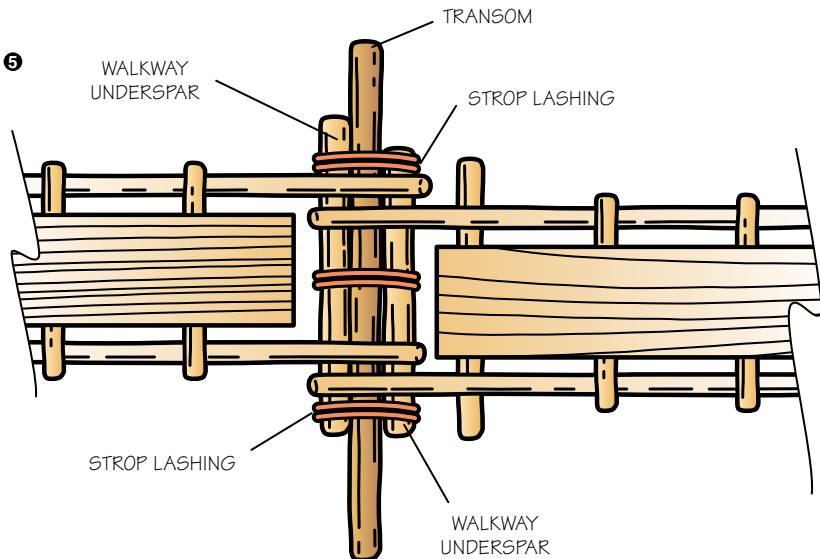



Pioneering Resources

Scouting Literature

Boy Scout Handbook; Guide to Safe Scouting; Deck of First Aid; Emergency First Aid pocket guide; Basic Illustrated Wilderness First Aid; Be Prepared First Aid Book; Basic Illustrated Outdoor Knots; Deck of Knots; Knots and How to Tie Them; Camping, Climbing, First Aid, Model Design and Building, Textile, and Woodwork merit badge pamphlets

Visit the Boy Scouts of America's official retail Web site (with your parent's permission) at <http://www.scoutstuff.org> for a complete listing of all merit badge pamphlets and other helpful Scouting materials and supplies.

Books

- Ashley, Clifford W. *The Ashley Book of Knots*. Doubleday, 1976.
- Biddlecombe, George. *The Art of Rigging*. Dover, 1990.
- Bigon, Mario, and Guido Regazzoni. *The Morrow Guide to Knots*. William Morrow, 1988.
- Budworth, Geoffrey. *The Illustrated Encyclopedia of Knots*. Globe Pequot Press, 2002.
- . *The Ultimate Encyclopedia of Knots & Ropework*. Lorenz Books, 1999.
- Day, Cyrus Lawrence. *The Art of Knotting and Splicing*. Naval Institute Press, 1986.
- . *Knots and Splices*. McGraw-Hill, 1989.
- Pawson, Des. *Handbook of Knots: Expanded Edition*. DK Publishing, 2004.
- . *Knot Craft: 28 Ropework Projects*. Paradise Cay, 2004.
- . *Pocket Guide to Knots & Splices*. Chartwell Books, 2001.
- Perry, Gordon. *Knots: A Practical Step-by-Step Guide to Tying Over 100 Knots*. Barnes & Noble Books, 2002.
- Salvadori, Mario; Saralinda Hooker; and Christopher Ragus. *The Art of Construction: Projects and Principles for Beginning Engineers and Architects*. Chicago Review Press, 1990.
- Smith, Hervey Garrett. *The Arts of the Sailor: Knotting, Splicing and Ropework*. Dover, 1990.
- . *The Marlinspike Sailor*. McGraw-Hill, 1993.

Sweet, John. *Scout Pioneering*.
Scout Association, 1974.

Toghill, Jeff. *Knots and Splices*.
Sheridan House, 1998.

Toss, Brion. *The Complete Rigger's
Apprentice: Tools and Techniques
for Modern and Traditional Rigging*.
McGraw-Hill, 1997.

Acknowledgments

The Boy Scouts of America thanks Dan and Gretchen Walters, Stoughton, Wisconsin, for their assistance with this new edition of the *Pioneering* merit badge pamphlet. They were generous with their time and knowledge, and their hard work and persistence helped form the revised requirements and shape the manuscript.

Many Scouters and avid pioneering experts assisted with the development of the revised requirements, and we are grateful for their input. Among these individuals were Ken Hammond, Richard Jahn, Mike Kleckner, Ken Knowles, R. G. Kruger, Brian Nulle, Paul Oliphant, Clarence Olson, Bill Schrichte, and Elaine Waraczynski.

We are grateful to pioneering legend Adolph Peschke, West Des Moines, Iowa, for writing the 1993 edition of the *Pioneering* merit badge pamphlet. Mr. Peschke's son, Donald Peschke, also was instrumental in the development of the 1993 edition. Many of the techniques shown in that edition were adapted for the 2006 edition.

Photo and Illustration Credits

©Photos.com—pages 12, 13, 15, 17,
18 (*all*), 20, 21, and 46

All other photos and illustrations not mentioned above are the property of or are protected by the Boy Scouts of America.

Eric Bakke—page 10

Dan Bryant—page 11

John McDearmon—pages 24–27 (*all*),
29–30 (*all*), 31 (*illustrations*), 32–39
(*all*), 41–45 (*all*), 47–50 (*all*), 53–56
(*all*), 57 (*illustration*), 60–61 (*all*),
62 (*illustrations*), 63 (*all*), 64 (*illus-*
trations), 65 (*illustrations*), 66–69
(*all*), 79–83 (*all*), and 87–93 (*all*).

Christian Michaels—page 14



MERIT BADGE LIBRARY

Though intended as an aid to Boy Scouts, Varsity Scouts, and qualified Venturers in meeting merit badge requirements, these pamphlets are of general interest and are made available by many schools and public libraries. The latest revision date of each pamphlet might not correspond with the copyright date shown below, because this list is corrected only once a year, in January. Any number of merit badge pamphlets may be revised throughout the year; others are simply reprinted until a revision becomes necessary.

If a Scout has already started working on a merit badge when a new edition for that pamphlet is introduced, he should continue to use the same merit badge pamphlet to earn the badge. He should fulfill the requirements listed in the pamphlet he was using when he began. In other words, the Scout need not start all over again with the new pamphlet and possibly revised requirements.

Merit Badge Pamphlet	Year	Merit Badge Pamphlet	Year	Merit Badge Pamphlet	Year
American Business	2002	Engineering	2000	Photography	2005
American Cultures	2005	Entrepreneurship	2008	Pioneering	2008
American Heritage	2005	Environmental Science	2008	Plant Science	2005
American Labor	2008	Family Life	2005	Plumbing	2004
Animal Science	2008	Farm Mechanics	1997	Pottery	2002
Archaeology	2008	Fingerprinting	2003	Public Health	2005
Archery	2004	First Aid	2004	Public Speaking	2002
Architecture	2004	First Aid	2007	Pulp and Paper	2008
Art	2008	Fish and Wildlife Management	2004	Radio	2001
Astronomy	2004	Fishing	2002	Railroading	2003
Athletics	2008	Fly-Fishing	2002	Reading	2003
Auto Mechanics	2000	Forestry	2005	Reptile and Amphibian Study	2005
Aviation	2008	Gardening	2002	Rifle Shooting	2001
Backpacking	2007	Genealogy	2005	Rowing	2008
Basketry	2003	Geology	2005	Safety	2008
Bird Study	2005	Golf	2002	Salesmanship	2003
Bugling (See Music)		Graphic Arts	2008	Scholarship	2004
Camping	2005	Hiking	2007	Sculpture	2007
Canoing	2004	Home Repairs	2002	Shotgun Shooting	2005
Chemistry	2004	Horsemanship	2004	Skating	2005
Cinematography	2001	Indian Lore	2003	Small-Boat Sailing	2004
Citizenship in the Community	2005	Insect Study	2002	Snow Sports	2007
Citizenship in the Nation	2005	Journalism	2008	Soil and Water Conservation	2004
Citizenship in the World	2005	Landscape Architecture	2002	Space Exploration	2004
Climbing	2008	Law	2003	Sports	2008
Coin Collecting	2002	Leatherwork	2002	Stamp Collecting	2007
Collections	2003	Lifesaving	2001	Surveying	2004
Communications	2003	Mammal Study	2003	Swimming	2002
Composite Materials	2008	Medicine	2002	Textile	2003
Computers	2005	Metallurgy	2007	Theater	2005
Cooking	2007	Model Design and Building	2003	Traffic Safety	2008
Crime Prevention	2005	Motorboating	1992	Truck Transportation	2005
Cycling	2003	Music and Bugling	2003	Veterinary Medicine	2005
Dentistry	2008	Nature	2003	Water Sports	2007
Disabilities Awareness	2005	Nuclear Science	2004	Weather	2008
Dog Care	2003	Oceanography	2003	Whitewater	2005
Drafting	1993	Orienteering	2003	Wilderness Survival	2007
Electricity	2004	Painting	2002	Wood Carving	2008
Electronics	2004	Personal Fitness	2008	Woodwork	2003
Emergency Preparedness	2003	Personal Management	2003		
Energy	2005	Pets	2005		

BOY SCOUTS OF AMERICA • SUPPLY DIVISION

NATIONAL DISTRIBUTION CENTER

2109 Westinghouse Boulevard
P.O. Box 7143
Charlotte, NC 28241-7143

www.scoutstuff.org

DIRECT MAIL CENTER

P.O. Box 909
Pineville, NC 28134-0909
For fast credit card orders—
VISA, MasterCard, American Express—
call BSA operators toll-free
1-800-323-0732



PHILMONT SCOUT RANCH



NORTHERN TIER



EAGLE SCOUT



FLORIDA SEA BASE

ON THE ROAD TO HIGH ADVENTURE

THE SUPPLY GROUP IS
READY TO BE A PARTNER
ON YOUR TRAIL TO
EAGLE THROUGH HIGH
ADVENTURE. THE
ADVENTURE IS YOURS,
AND WE ARE READY
WITH THE GEAR YOU
WILL NEED. YOU CAN
DEPEND ON THE LATEST
IN LIGHTWEIGHT,
DURABLE, QUALITY
GEAR THAT WILL
MEET AND SURPASS
YOUR TOUGHEST
REQUIREMENTS.



WWW.SCOUTSTUFF.ORG

#35931



7 30176 35931 1