

HOW TO USE THIS PAMPHLET

The secret to successfully earning a merit badge is for you to use both the pamphlet and the suggestions of your counselor.

Your counselor can be as important to you as a coach is to an athlete. Use all of the resources your counselor can make available to you. This may be the best chance you will have to learn about this particular subject. Make it count.

If you or your counselor feels that any information in this pamphlet is incorrect, please let us know. Please state your source of information.

Merit badge pamphlets are reprinted annually and requirements updated regularly. Your suggestions for improvement are welcome.

Send comments along with a brief statement about yourself to Boy Scout Division • Boy Scouts of America • 1325 West Walnut Hill Lane • P.O. Box 152079 • Irving, TX 75015-2079.

WHO PAYS FOR THIS PAMPHLET?

This merit badge pamphlet is one in a series of more than 100 covering all kinds of hobby and career subjects. It is made available for you to buy as a service of the national and local councils, Boy Scouts of America. The costs of the development, writing, and editing of the merit badge pamphlets are paid for by the Boy Scouts of America in order to bring you the best book at a reasonable price.



BOY SCOUTS OF AMERICA
MERIT BADGE SERIES

DRAFTING



BOY SCOUTS  OF AMERICA®

Requirements

1. Format TWO sheets of drawing paper with proper borders and title blocks—one for your manual project (see requirement 2) and one for your lettering project (see requirement 5).
 - a. Make a rough sketch for each of your project drawings to determine the correct size of paper to format.
 - b. Using either single-stroke vertical or slant Gothic lettering, fill in all important information in the title block sections of the formatted paper.
2. Using the formatted sheet of paper you prepared for your manual project, produce a pencil drawing as it would be used for manufacturing. Fill in all title block information. The manual drawing may be any one of the following drawing types:
 - a. **Architectural:** Make a scale drawing of an architectural project. The architectural drawing may be a floor plan; electrical, plumbing, or mechanical service plan; elevation plan; or landscaping plan. Use an architect's scale and show dimensions to communicate the actual size of features. Include any important notes and considerations necessary for construction.
 - b. **Mechanical:** Make a scale drawing of some mechanical device or interesting object. The mechanical drawing may be of the orthographic or isometric style. Use an engineer's scale and show dimensions to communicate the actual size of features. Include any important notes and manufacturing considerations.
 - c. **Electrical:** Draw a simple schematic of a radio or electronic circuit. Properly print a bill of materials including all of the major electrical components used in the circuit. Use standard drawing symbols to represent the electronic components.
3. Produce a computer-aided design (CAD) drawing as it would be used in manufacturing. Fill in all title block information. The CAD drawing may be any one of the following drawing types:
 - a. **Architectural:** Make a scale drawing of an architectural project. The architectural drawing may be a floor plan; electrical, plumbing, or mechanical service plan; elevation plan; or landscaping plan. Use an architect's scale and show dimensions to communicate the actual size of features. Include any important notes and considerations necessary for construction.
 - b. **Mechanical:** Make a scale drawing of some mechanical device or interesting object. The mechanical drawing may be of the orthographic or isometric style. Use an engineer's scale and show dimensions to communicate the actual size of features. Include any important notes and manufacturing considerations.
 - c. **Electrical:** Draw a simple schematic of a radio or electronic circuit. Properly print a bill of materials including all of the major electrical components used in the circuit. Use standard drawing symbols to represent the electronic components.
4. Discuss with your counselor how fulfilling requirements 2 and 3 differed from each other. Tell about the benefits derived from using CAD for requirement 3. Include in your discussion the software you used as well as other software options that are available.

5. Using single-stroke slant or vertical Gothic lettering (without the aid of a template or lettering guide), write a brief explanation of what you consider to be the most important benefit in using CAD in a particular industry (aerospace, electronics, manufacturing, architectural, or other). Use the experience gained in fulfilling requirements 2, 3, and 4 to support your opinion. Use the formatted sheet of paper you prepared in requirement 1 for your lettering project.
6. Do ONE of the following (a or b):
 - a. Visit a facility or industry workplace where drafting is part of the business. Ask to see an example of the work that is done there, the different drafting facilities, and the tools used.
 - (1) Find out how much of the drafting done there is manual and how much is done using CAD. If CAD is used, find out what software is used and how and why it was chosen.
 - (2) Ask about the drafting services provided. Ask who uses the designs produced in the drafting area and how those designs are used. Discuss how the professionals who perform drafting cooperate with other individuals in the drafting area and other areas of the business.
 - (3) Ask how important the role of drafting is to producing the end product or service that this business supplies. Find out how drafting contributes to the company's end product or service.
 - b. Using resources you find on your own such as at the library and on the Internet (with your parent's permission), learn more about the drafting trade and discuss the following with your counselor.
 - (1) The drafting tools used in the past—why and how they were used. Explain which tools are still used today and how their use has changed with the advent of new tools. Discuss which tools are being made obsolete by newer tools in the industry.

- (2) Tell what media types were used in the past and how drawings were used, stored, and reproduced. Tell how the advent of CAD has changed the media used, and discuss how these changes affect the storage or reproduction of drawings.
 - (3) Discuss whether the types of media have changed such that there are new uses for the drawings, or other outputs, produced by designers. Briefly discuss how new media types are used in the industry today.
7. Find out about three career opportunities in drafting. Pick one and find out the education, training, and experience required for this profession. Discuss this with your counselor, and explain why this profession might interest you.





Drafting a Better World

What does the Sears Tower in Chicago have in common with your handheld video game? How is a space station like the storage shed in your backyard? In what way do the dazzling neon lights of New York City resemble the desk lamp you use when doing your homework? In each case, from the most massive superprojects to the tiniest electronic gizmo, a design had to be made before the object could be built.

Our modern world thrives on new ideas—inventing new products and processes, laying the infrastructure to house and transport an ever-growing population, expanding the reach of digital technology. But before the first board can be nailed for a new house, the first circuit fabricated for a new mobile phone, or the first bucket of concrete poured for a new roadway, a drawing must be made to show exactly how to get the project done.

Creating the drawings that guide the hands of builders, engineers, electricians, scientists, and craftspeople is the task of the drafting professional. He or she draws, or “drafts,” the design on paper or the computer screen. The drafter’s work is used for planning and building machines, computers, cars, homes, skyscrapers, roads, video games—virtually everything that must be made to precise specifications.



Using universally accepted symbols, a drafter’s plans can be read by any engineer or trades worker, no matter the country or language of origin.

These days, much drafting work is done on computer, but the basic concepts and principles of the skill have remained the same for centuries. You can learn basic drafting in your own home, with or without the help of a computer, using inexpensive tools, supplies, and software. As you begin drafting, you will learn the symbols, lines, and drawing forms and techniques that will enable you to turn a rough sketch into a professional drawing. You will see how to present all of the information a craftsperson will need to build the project. You will learn the importance of showing precise, accurate details in a clean, simple format.



By the time you earn the Drafting merit badge, you will be able to draw plans for projects like a birdhouse, a bookcase, or a backyard storage shed. You might even draw rough plans for your family's dream house, complete with game room and swimming pool. More importantly, you will be grounded in an age-old profession that remains a vital part of many modern technical careers. You may also want to explore other professions that use drafting, such as architecture, engineering, graphic design, and art.

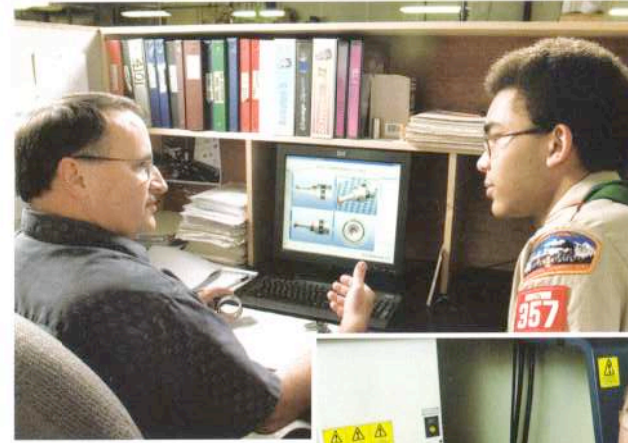



Tools of the Trade

A straight edge (ruler), a pencil, a flat and smooth surface, and some paper are all you need to get started in drafting. As you advance, though, you will want to try out some of the many other basic tools that drafting professionals use.

A **drafting table** has a top that can be angled upward for easier drawing. It may also have a lip at the bottom edge for holding pencils and other drafting tools.

To easily draw horizontal lines, the drafts person can place a **T-square** on the drafting table. The short end of the "T" rests against the side of the table, while the long part extends across the table. The T-square can be moved up and down along the table for drawing straight horizontal lines anywhere on the paper.

To draw vertical (right-angle) lines, or other straight lines that are not horizontal, rest a **triangle** on the T-square. Triangles, including adjustable triangles, are available for making lines at different angles. A **protractor** helps you draw lines of still more angles.

For many years, the system of T-squares and triangles was drafting's main tool kit. Then came the *drafting machine*, which attaches to the drafting table and makes drafting easier and quicker. This tool has a built-in protractor for drawing lines of many angles, replacing the T-square and triangle system.

For drawing circles, curves, and arcs, drafters use a **compass**, an adjustable drawing device with two hinged arms, and a **French curve**, a piece of plastic with traceable, complex curves cut into it. Other basic drafting tools include **drafting pencils** with leads of different weights, **technical pens**, and specialized **papers** and **erasers**, as well as plastic **templates** cut with different shapes for easily drawing the symbols used in drafting.

In manual drafting, the traditional drafting paper is known as *vellum*. Almost transparent, vellum is used to create blueprints from the original drawings. It is available in a wide variety of sizes.



Since computers entered the drafting industry in the 1970s, their use has grown dramatically.

Using Computers in Drafting

The most powerful drafting tool of all is the computer, running special software for *computer-aided drafting* (CAD). Drafting by computer has many advantages.

Efficiency. Computers make it easy to do tasks that once were difficult and time-consuming. Lettering, for example, takes lots of time and skill to do neatly by hand. On a computer, it is as easy as typing on a keyboard.

Accuracy. With computers, accuracy is easier to achieve—for example, computers allow the drafter to quickly draw multiple lines to the exact same length. Manual drawing may be accurate enough for many designs, but many others, such as tiny electronic circuits, demand much greater accuracy than can be achieved on paper. Corrections can be made quickly and easily, without having to erase pencil marks. Also, changing one dimension can automatically alter related dimensions accordingly, saving hours of tedious work.

Easy repetition. Computers make it easy to draw the same shape over and over. Imagine drawing a bicycle chain. Each of the many chain links is identical, but without CAD, each link would have to be drawn by hand. With CAD, the designer can draw just one link and use the computer to repeat the pattern for the entire chain.

Computers can depict lines and features using units of millionths of an inch or even smaller.

Practicality. Computers take up less space than the drafting boards needed for manual drafting. This allows engineering offices, for example, to be filled with normal-size desks and work spaces, instead of needing a large room filled with big drafting tables.

Standard appearance. With CAD, all designers in the same company can produce drawings with the same style of lettering and drawing. This allows all jobs to have a common feel to them instead of reflecting a mix of styles depending on which designer worked on the project. Thus, the company's work looks more professional.

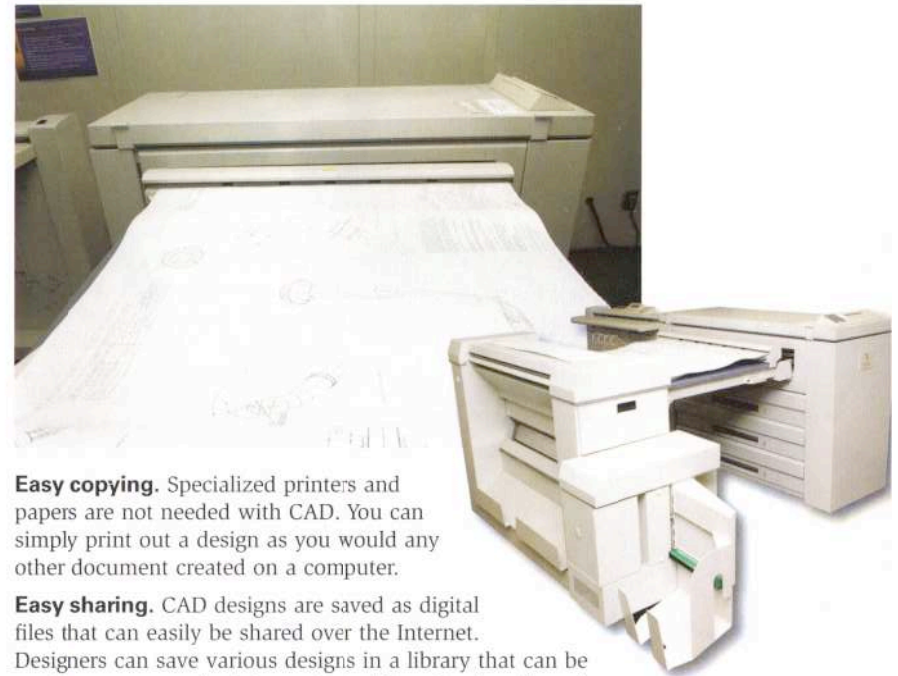

Easy copying. Specialized printers and papers are not needed with CAD. You can simply print out a design as you would any other document created on a computer.

Easy sharing. CAD designs are saved as digital files that can easily be shared over the Internet. Designers can save various designs in a library that can be used as a resource for later projects. They simply call up the file of an old design and use it as the basis of a new design without having to start from scratch. Designers sometimes need to share information while a work is in progress. Different designers may be working on various parts of a larger design—say, a car—at the same time. With CAD, they can share their work as they proceed, via e-mail or a computer network.

Keep in mind that CAD systems—like the older T-squares and triangles—are merely tools to help you be a better drafter.

CAD programs can make use of various computer accessories, such as a graphics tablet, a *stylus* or *light pen* for drawing on the tablet or monitor, and a special kind of souped-up computer mouse that has a magnifying glass with crosshairs for precise tracing. A design made using CAD can be saved to a file or printed on a hard copy, although some projects still use specialized *plotters*.



CAD does not eliminate the need to learn the principles of drafting nor the skills of drafting by hand. Not all professional drafters have the use of a CAD program, and computers are not always portable enough to take everywhere a design drawing is needed. Also, some types of design are still done better by hand, so learning manual drafting is a must.

Beyond Computer-Aided Drafting

Computers can go far beyond what is possible with paper drawings. Objects can be “modeled” in three dimensions on the computer screen, rotated and turned as though you were holding the object in your hand. This is something no manual draftsman could ever do with pencil and paper.

Using a powerful modeling program takes us beyond computer-aided drafting into *computer-aided design*, which, confusingly, is commonly known as CAD, the same letters as for computer-aided drafting. The two disciplines are sometimes combined as *computer-aided drafting and design* (CADD). In CADD, the designer (an automotive engineer, for example) can assemble several object models on the computer screen, seeing how well the object fits and interacts as part of a larger assembly.

Some powerful design programs can assign physical properties to the computer model. Then the computer program can analyze the strength of that object and how much it will weigh when built. This kind of analysis is part of *computer-aided engineering* (CAE).

After an object has been drawn, designed, and engineered, it might also move on to the next step—*computer-aided manufacturing* (CAM). The computer-created model of an object—say, a car part—is transferred directly to computer-controlled machines that can produce the object. In other words, a physical copy of the part can be made without ever having been shown on paper.

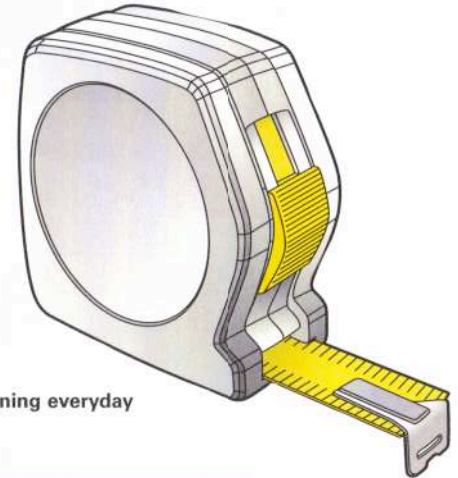

CADD is an enormous benefit for designing everyday objects, too, such as a tape measure.

Engineers use CAE to find out if a part will break, vibrate too much, or perform poorly when exposed to heat. All of this vital information can be learned before the object is ever actually made.

Using CAD to Build Better Cars

David Oakley is a CAD designer for Ford Motor Company in Detroit, Michigan. He uses an advanced CAD software program called CATIA, which allows him to design objects on the computer screen in three dimensions.

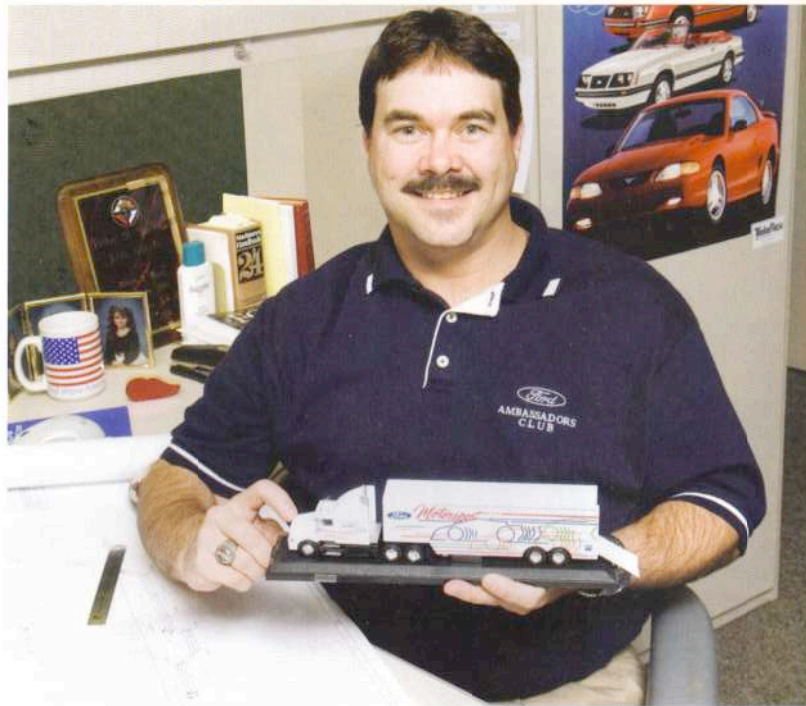

David designs some of the thousands of parts that go into making vehicles. He might work on the brakes, the suspension, or the fuel system. Sometimes he must change a design because some other part on the vehicle is altered. "The car or truck is in constant flux until the prototype is produced," he says.

Once, he had designed a fuel tank for a truck that fit perfectly, only to be told that he must shave 2 inches off the width to fit a change in the floor assembly. "We made it work," he says. Adapting to change is part of the designer's duty.

David's greatest satisfaction in his work comes when he finds a way to make a part that is lighter, stronger, and more economical to build. For example, he redesigned the plastic air deflector shield that fits under the front bumper of the Ford Focus passenger car. His new design shaved 6 pounds off the weight of the part and more than \$7 off the cost to produce it.

When you consider that hundreds of thousands of cars will be built with the new part, David's design will save the company more than \$5.3 million—and it will save car owners money by letting them go farther on a tank of gas because of the car's lighter weight. It's easy to see the value of a good CAD designer.

David says opportunities are good for young people entering the field with the latest technical skills: "This work is great for people who are creative, like to draw, and have a good feel for mechanics or electronics."

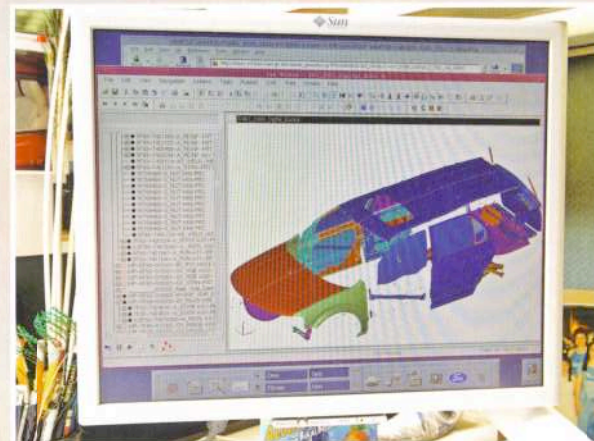



Sketching, Scale Drawings, and Lettering

Drafters must be skilled at sketching, making scale drawings, and neatly lettering their finished drawings.



Sketching

Most drawings begin with sketches. A sketch is simply a rough draft, little more than an outline of an object showing its main features but not much detail. Sketches help the drafter visualize what the more finished drawing will look like. Sketching also helps the drafter decide which drawing technique would be best to show an object's features.

Sketching helps the drafter plan the drawing's format, where to place the views, and how much room is needed for notes and other important information. It is important to develop sketching skills whether the finished drawing is created with instruments or with a CAD computer program.

The two illustrations show the contrast between sketch and finished drawing. Both drawings are of an architectural floor plan. Floor plans are drawn as though seen by a bird—that is, from above—with the roof and ceiling of the building removed.

The first illustration was drawn freehand and shows walls, doors, windows, electrical outlets, fixtures, etc. The room was measured and the sketch dimensioned (that is, the room's measurements are shown on the sketch). For the finished drawing, the sketch was redrawn to scale using drafting instruments, and neatly lettered.

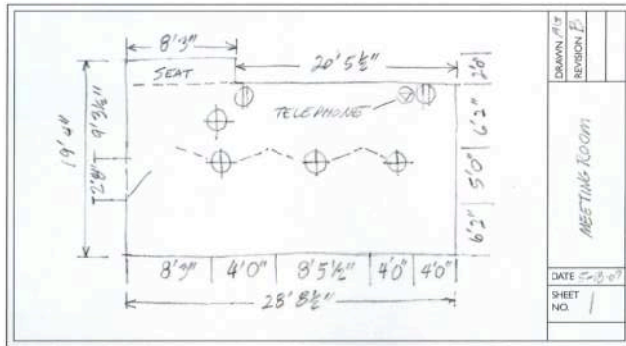

A freehand sketch

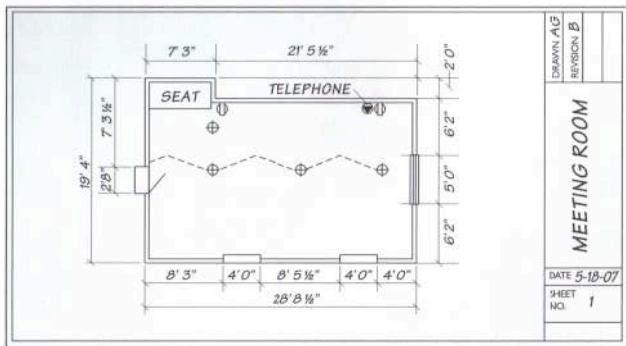

The sketch redrawn to scale using drafting instruments, and neatly lettered

Industry-standard symbols are used for this type of drawing. (See "The Symbols of Drafting" later in this pamphlet.) Becoming familiar with these symbols will help you to make sketches quickly and ensure that all the important features of the sketch are transferred to the final drawing.

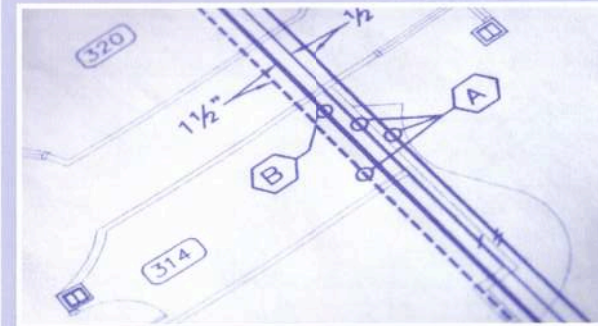

When sketching freehand, it is easiest to use grid paper, which has lines to help judge proportion and alignment.

Drafters use pencils with varying degrees of hardness and different types of points, depending on what part of the sketch they are working on, such as when outlining an object or shading the object. Buy a few different types of pencils and experiment with them on your own drawings.

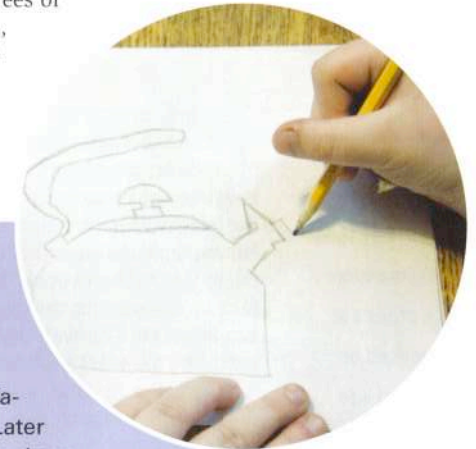

Get started by sketching simple objects around the house—a book lying on a table, for instance, or the table itself. Grid paper will help keep the lines straight. If you find sketching unfamiliar and difficult, don't worry. Later sections in this pamphlet on scale drawings and the different "views" used in drafting will give some structure to your efforts.

Making Scale Drawings

The drawings we make of an object are rarely the actual size of the object. Usually, drawings are smaller, and for good reason. How awkward it would be if the drawing of a car were as big as the car itself! With other objects, however, such as electronic circuits, the drawing will be many times larger than the actual object.

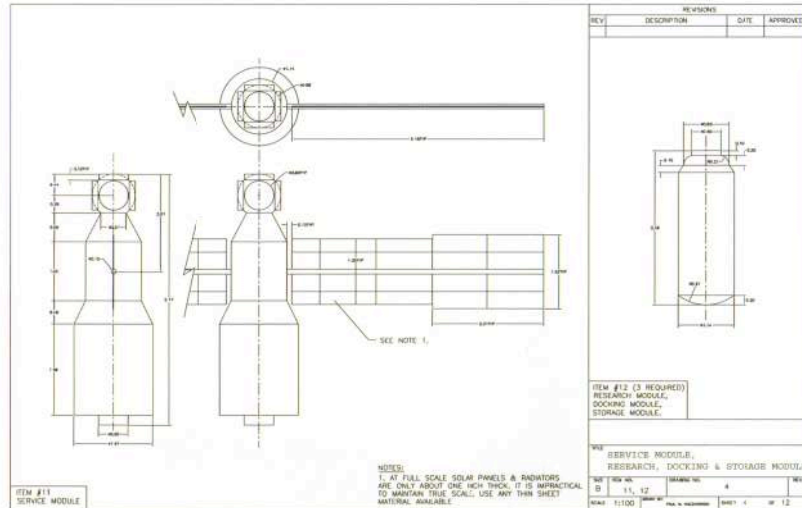

A drawing that accurately reflects the dimensions of a project at a reduced or enlarged size is called a *scale drawing*.

Even though a drawing is far different in size than the object it represents, it must still be extremely accurate. That is where the concept of “scale” applies. Simply put, *scale* is the relationship or proportion between two sets of dimensions. For example, in an architect’s drawing of a house, the scale might be “1/4 inch equals 1 foot.” That means that every quarter inch of distance on the drawing represents 12 inches of the actual house. The wall of a room intended to be 12 feet long would be shown 3 inches long in the drawing.

Drawing to scale means fitting your drawing to the size of the paper without changing the proportions of the object, area, or building you are drawing. You can choose whatever scale you want; just be sure to label the drawing accordingly. Choose a scale that will make the drawing as large as possible without crowding it on the paper.

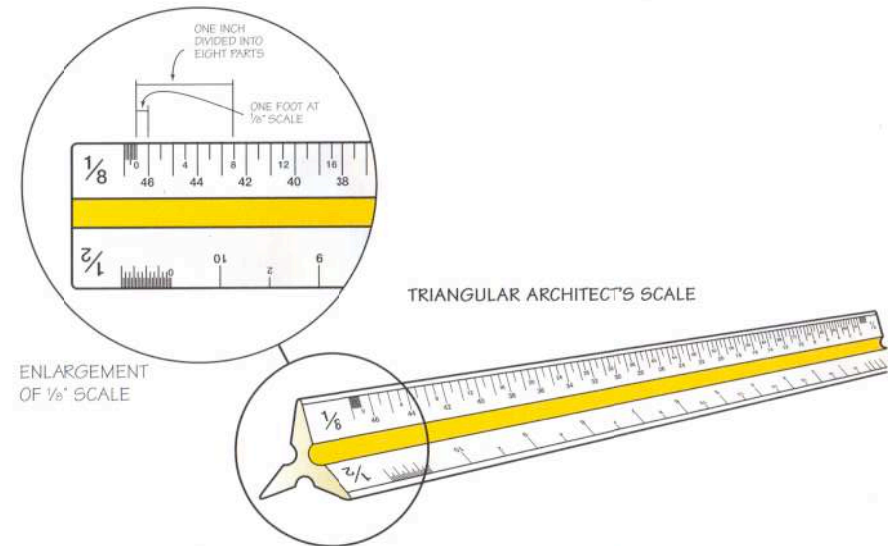

A special ruler used to measure or draw a scale drawing is called an *architect’s scale*. This ruler divides dimensions for you, simplifying the process of measuring or drawing objects that are larger than the paper or smaller than you want them shown. By comparison, an *engineer’s scale* is more detailed and shows fractions up to sixtieths of an inch.

Dimensioning

When a drawing is made to scale, the craftsman or engineer who is working with the plans can determine the real-life dimension of any object in the drawing by referring to the scale—simply measuring the line in the drawing and then applying the proportion of the scale. Keep in mind that parts of the drawing might be small and hard to measure, or perhaps the paper might shrink or expand with heat or cold and moisture, which would throw off the measurement. For those reasons, drafters add numbers to drawings to indicate the object’s actual dimensions. Dimensioning typically includes:

- The **overall dimensions** of the project—the length, width, and (if required by your drawing) depth of the entire project
- The **location dimensions**—positioning a window or door, for instance, within the drawing
- The **size dimensions**—indicating, for example, how big the window or door should be

Use the dimension and extension lines discussed in the "Symbols of Drafting" chapter. The dimensions of angles are indicated by an arc inside the angle.

Dimensions should be lettered neatly for easy reading and positioned so they can be read from the bottom of the sheet. Including more dimensions than are needed for the purpose of the drawing could make the drawing look cluttered or confusing, dimensioning should be so complete that the person reading the drawing does not need to use mathematics to understand sizes.

Like the tools of the drafting trade discussed earlier, the methods of reproducing finished drawings have been revolutionized by computer technology. Copy machines and computer printers have taken over, largely replacing some older ways of duplicating designs.

A *blueprint* is a copy of a drawing made on vellum. By laying the vellum on light-sensitized blueprint paper and passing a high-intensity light through the drawing onto the blueprint, a special coating on the blueprint paper turns blue. The lines on the drawing prevent light from passing through to the paper; in this way, they remain white. The coating on the paper is then washed off and the paper is dried; the result is white lines on a blue background. This process is no longer used in the industry. The term "blueprint," as it is used today, refers more accurately to the *blueline diazo* method of reproducing drawings.

The *diazo* process produces prints exactly the opposite of blueprints—that is, white copies with blue, brown, or black lines that more closely resemble the original drawing. *Diazo* uses a bright light that passes through the vellum drawing, exposing the light-sensitive *diazo* paper underneath. The copy is then immediately fed through a developer that reveals the lines of the drawing.

Until recent years, the size limitations and cost of standard *photocopiers* made this duplication process impractical. Now, however, continuous, roll-fed copy paper can be used to reproduce any size of drawing. Drawings can be duplicated even on new vellum. This allows the user to enlarge or reduce the drawing on the copy.

CAD plotters are a special kind of computer printer using pens, often colored pens. A pen plotter draws original or duplicate drawings outputted from a CAD computer program. Usually, only the original drawing is made with the plotter; other copy methods are used to reproduce the original.

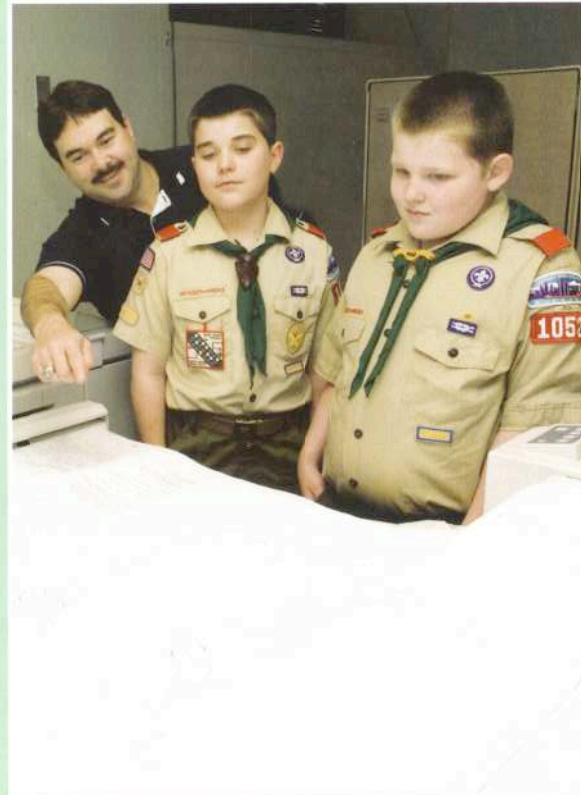

Laser or ink-jet printers are common forms of computer printers often used to print CAD designs. Laser printers are more precise than ink-jet but more expensive. Both types of printers can print in color.

The use of computers and printers has greatly reduced the need for blueprinting or *diazo* reproductions and for special papers such as vellum.

Lettering

In all types of drafting, it is important to write clearly and neatly. After all, the purpose of a drawing is to communicate an idea. The ability to write clearly is a critical factor in achieving that goal.

Because of this, drafters devote a lot of practice and effort to lettering. In drafting, *Gothic* and *Roman* letters are used because they are easy to read and draw. Engineering professionals use only single-stroke Gothic letters, either vertical or inclined. Architectural draftspersons use a more stylized variation of single-stroke Roman letters, usually inclined. Either style of lettering can be extended or compressed to fit a certain length of line.



Mechanical and electrical lettering



Architectural lettering

Lettering is just as important to master as other drawing techniques. Often, more information is contained in the notes than in the drawing itself. Illegible printing can cause the craftsperson to overlook critical information.

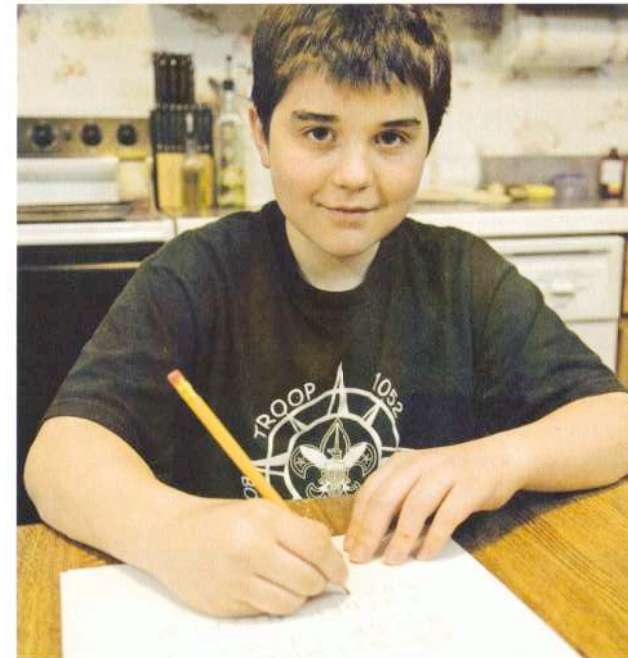

Before lettering, draw light guidelines on the paper; erase the guidelines after lettering is complete. Using guidelines helps ensure that lettering will be straight and evenly spaced between the lines.

Requirement 5 for this merit badge is to letter a formatted page. Start by drawing guidelines about 1/4 inch high (like the lines on loose-leaf notebook paper). Keep the text evenly spaced as you letter; if you step back from the page, you should not see any gaps or crowded letters.

Lettering templates can help with rapid lettering, but it is important to master freehand lettering first, even if you eventually do most of your lettering by computer. In CAD, lettering is as easy as typing on a keyboard. The different styles of lettering available in CAD are called *fonts*. Roman and Gothic letters are just two of the hundreds of different fonts available for the draftsperson to use.



How an Architect Uses Drafting

Charles Linn is a licensed architect, a member of the American Institute of Architects' College of Fellows, and deputy editor of *Architectural Record* magazine. Here he answers questions about architectural drafting.

Q: How important are basic drafting skills in architecture?

A: Good drafting skills are crucial to the success of architects, because if you don't know how to draft, you won't be able to communicate your ideas. We use drawings to tell our clients what their building will look like, and we use them to tell the builders what they will build. Drafting is also important because we use drawings to help us predict whether our ideas will work before we actually start making a building. A really complicated building might have a thousand sheets of drawings.

Q: How have you used drafting and drawing techniques in your own career?

A: Like most architects, I use drafting for several purposes. One of them is to make what are called construction drawings. These are technical diagrams that tell the people who are going to build a building how big it is, what materials it will be made out of, and such things as where the wiring, heating, and plumbing will go.



Getty Center, Los Angeles, California; Richard Meier, architect

Drafting is also often used as the basis for making renderings. Renderings are like pieces of art. They can be either simple sketches or complicated, almost like paintings. The intent of a rendering is to help the viewer understand how the building will appear when it is finished. Renderings generally do not have enough technical detail to allow a person to build from them.

Q: Are manual drafting skills still useful in the age of computer-aided drafting and design? How about lettering?

A: Sure, manual drafting skills are still quite useful at times. A person needs only a T-square, triangle, a scale, pencil, and some paper in order to start making drawings. That setup is much less expensive than a computer, software, and a printer, and it can be used almost anywhere. In the hands of a skilled draftsman, there might be some situations where these tools will be faster than the computer.

Architectural lettering is quite useful because it is so legible. Many people have come up to me over the years and said, "Your handwriting is so straight and easy to read. You must be an architect!" Of course, that makes me very proud.

Q: How long did it take you to master lettering without the use of templates?

A: A few weeks. The main thing is that I had to practice a lot, and I used light guidelines to keep things straight. When lettering, I always use a small triangle to make the vertical strokes of letters such as I, L, K, and so on.

Q: What are the most satisfying aspects of learning drafting skills?

A: The first is the satisfaction of making a beautiful drawing in itself. The second is the thrill you get the first time you see a building that was built from your drawings.

Q: What advice would you have for someone earning the Drafting merit badge?

A: Be patient, and don't get discouraged if your drawings don't turn out to be perfect at first.

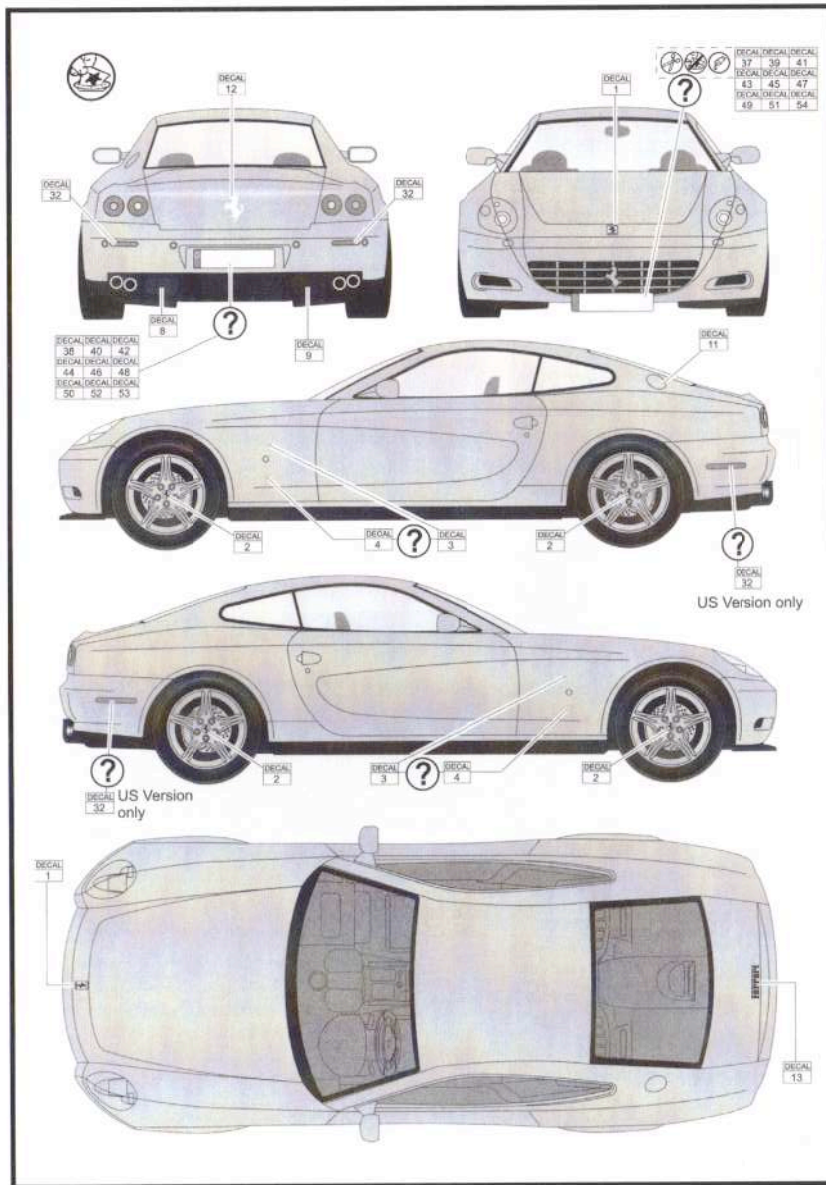

Views and Plans in Drafting

The views and plans created in drafting help architects, builders, engineers, and others to bring a project to completion.

Different Views

Draftspeople create drawings with different types of views depending on the purpose of the drawing. Each type of view is based on a straightforward method that you can follow to make drawing an object easier. Let's look at each of the major types of views, as well as some more specialized ones.

Orthographic Projection

One of the most common and easily understood styles of drawing is the *orthographic projection*. The word *orthographic* means, literally, "straight writing" or "straight drawing."

As it is used here, "projection" means a way of showing a three-dimensional object on a flat plane—that is, on a piece of paper.



These images depict a typical orthographic projection of an object, with straight-on front, side, and top views.

The orthographic projection offers “straight on” views of an object—for example, the front view, side view, and top view. In each case, you see only the height and width of the object, but not the depth. If you set a book on a table and crouch to look at the book straight-on with your eye at tabletop height, you will see a rectangle with a certain height and width. Consider this the *front view*.

Walk around the table and again put your eye at tabletop height. Now you are seeing the *side view* of the book. Stand up and look straight down on the book. This is the *top view*. You have just created an orthographic projection of the book. That is, you have viewed various planes of the book from different sides, with each side having a relationship to the other sides.

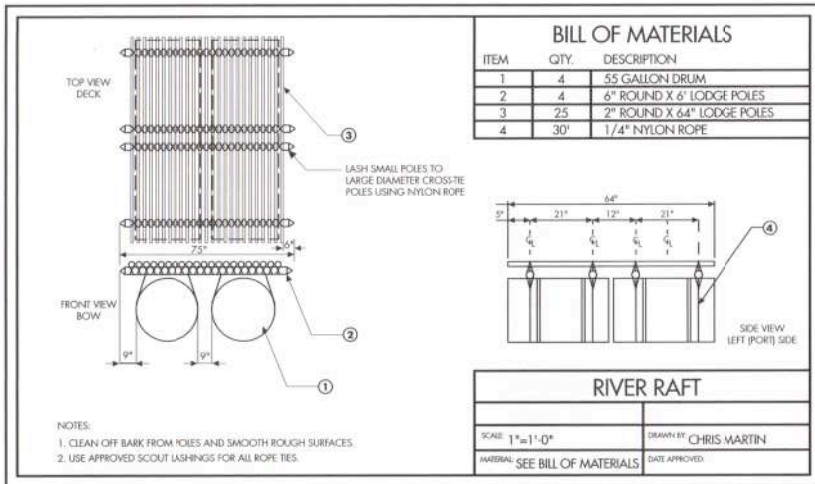

Orthographic projection: river raft

The illustration here shows a properly formatted drawing of a river raft. This orthographic projection shows the craftsper-son all the information necessary to build the raft. The top, front, and side views are all drawn in natural relationship to each other.

The side view shows where the flotation barrels are to be attached to the cross-tie poles and how they are to be lashed with the rope. Note that the raft’s deck poles, which run left and right in this view, are attached to the cross-tie poles at specific locations. This view shows where and how the deck poles are first lashed to the cross-tie poles.

The front view shows only the front of the first two barrels. The two rear barrels are behind the front barrels but are unseen from this view.

Remember that each view gives the craftsper-son only two-dimensional information. You can see that dimen-sional information in the front view could not possibly have been given to the craftsper-son in the side view.

Now look at the top view. You will see the width and length of the raft, each of which you saw in the front and side views, respectively. This time, however, you see them both at the same time. The length and width dimensions are not shown in the top view because they are already shown in the other two views.

If you look “through” the deck in the top view, you will see hidden (dotted) lines. These represent the four flotation barrels located underneath the deck. (Unlike pictorial styles, which are discussed later in this section, orthographic drawings show hidden features.)

Make an Orthographic Drawing

To make an orthographic drawing, start with the front view. Draw it true to the shape of the object, scaled to fit the paper. Then draw the top view by projecting lines from the front view. This ensures that the top view exactly lines up with the front view. This allows the reader to easily see the features in both views. Lastly, draw the side view. Again, project lines from the front view to make the side line up with the front.

To complete the drawing, add important notes and a *bill of materials* (a list of materials, and the quantity of each, used to build the object). The entire drawing should be centrally located on the paper, with no lines extending beyond its border. Fill in the title block sections, including the drawing scale. The drawing is now ready, and the building of the object (in this case, a raft) can begin.

It is unacceptable to dimension the same object of length more than one time in any single drawing.

Isometric Drawing

While an orthographic drawing shows different views arranged on the same page, an *isometric drawing* combines several views into one picture. The resulting image appears to have three dimensions (height, width, and depth), not just two. The isometric style looks similar to how the object would look in real life—but with an important difference.

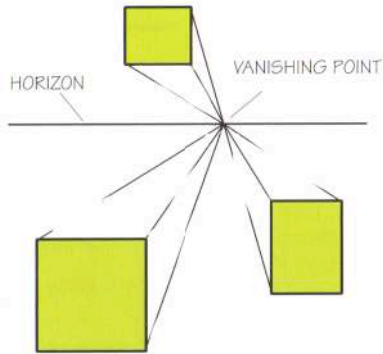

In a perspective drawing, the far-off parts look smaller and closer together than the nearby parts.

If you were to draw an object in three dimensions as it looks to you, it would have *perspective*. The parts farther from your eye would look smaller and closer together than those closer to your eye. To better understand this, imagine standing in the middle of a railroad track. The two rails seem far apart at your feet but much closer together in the distance—when, in fact, the rails are parallel, the same distance apart, all the way.

A drawing made with this perspective would look realistic, but making scale enlargements or reductions from it would be difficult. A three-dimensional isometric drawing, on the other hand, would show an equal distance between the rails near and far. This type of drawing can be reduced

or enlarged, through simple scale measurements, to the size required, without distorting the proportions.



An isometric drawing is built on a "skeleton" of three lines: the isometric axes.

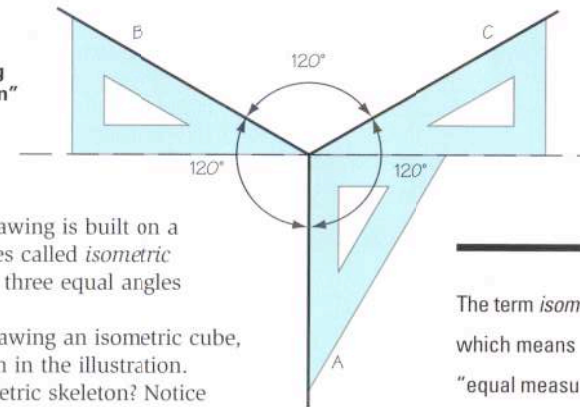

An isometric drawing is built on a skeleton of three lines called *isometric axes*. The lines form three equal angles of 120 degrees each.

Let's start by drawing an isometric cube, line by line as shown in the illustration. Do you see the isometric skeleton? Notice that all edges of the cube that are supposed to be the same length are actually drawn that way. You can see that all lines that would be vertical in an orthographic drawing are also vertical in isometric drawings. However, lines that would be horizontal in an orthographic drawing are tilted upward 30 degrees from horizontal.

The term *isometric*, which means "equal measures," comes from the three equal, 120-degree angles.

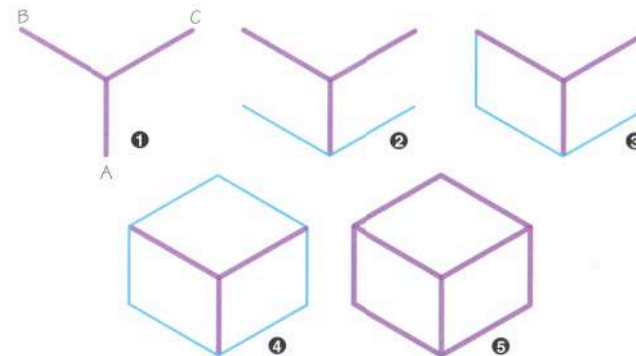

Drawing an isometric cube

If you want to enlarge or reduce this drawing, you can apply your draftsman's scale to lines A, B, and C and convert them to the scale you want in your larger or smaller drawing. You will then have a new skeleton to build on. Try this, and you will understand the isometric principle.

Now look at the other isometric drawings illustrated here. Notice the isometric skeleton in each of them. See how it defines the three dimensions? Study these drawings and practice drawing them a few times before you try to draw an actual object. It takes practice to figure out which edges should be based on the isometric axes. Notice that a framework is drawn before the shapes are defined.

Isometric drawings

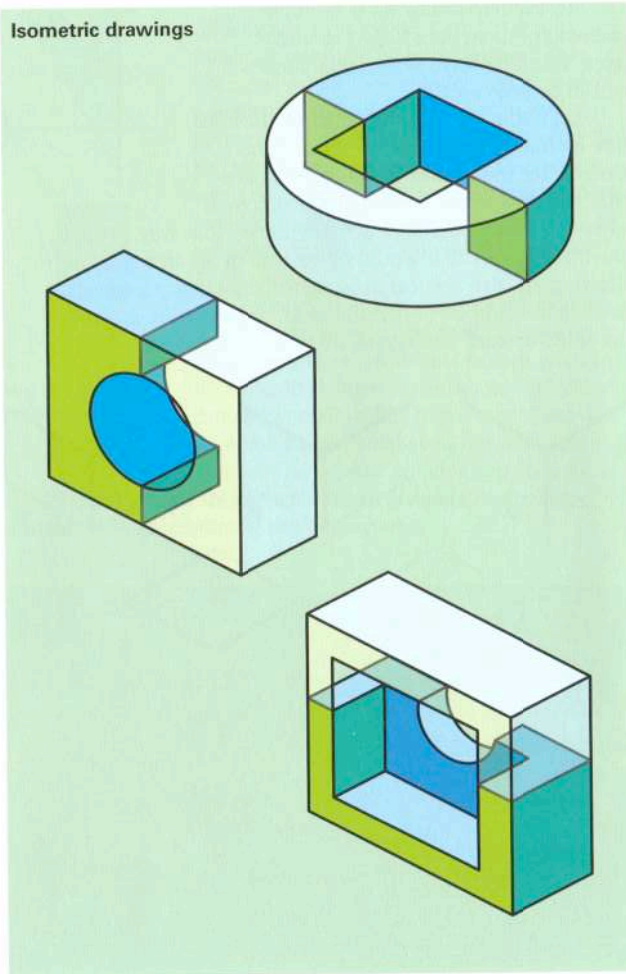

How to Make an Isometric Drawing of a Camera

Begin with orthographic views of a camera: top view, front view, and side view. (See the orthographic projection of a camera at the beginning of this chapter.) Then create an isometric series, adding an increasing number of details to each of four isometric drawings.

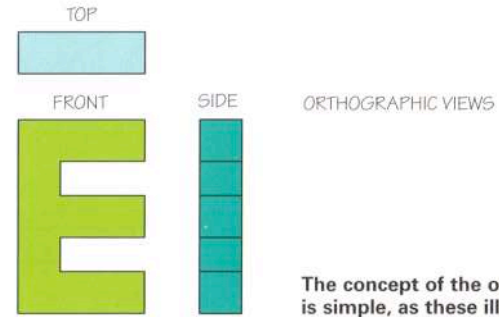

The concept of the orthographic view is simple, as these illustrations show.

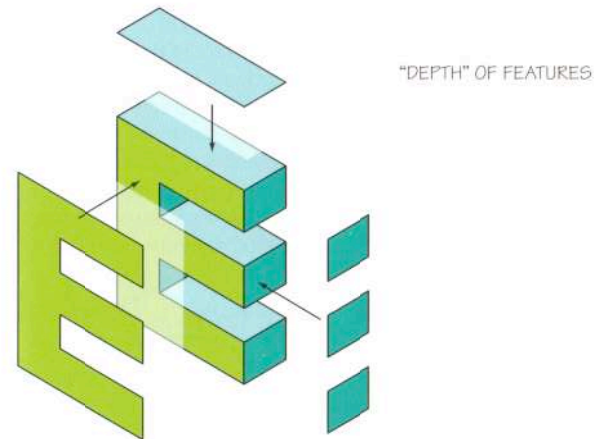

- Use lightweight lines in steps 1, 2, and 3.
- Step 1—Set up angles and draw in major features.
 - Step 2—Locate and sketch in the detailed features.
 - Step 3—Draw in the "depth" of the detail features.
 - Step 4—Darken object lines; add detail.

ISOMETRIC CIRCLES

To draw isometric circles, the *four-center approximation method* is most often used (see the illustration). Enclose the circle in a true square, then make an isometric drawing of the square. Mark off the points of *tangency* (where the circle and the true square intersect) on the isometric square.

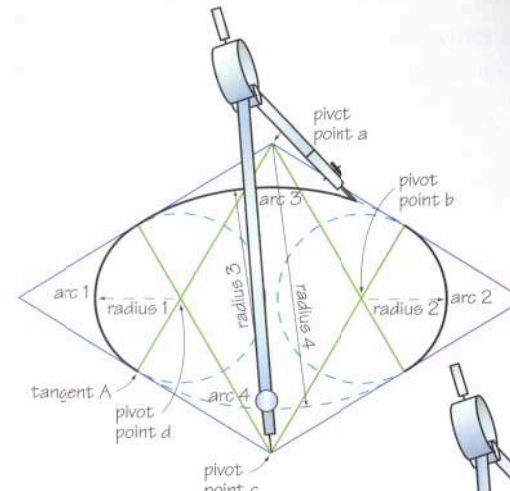
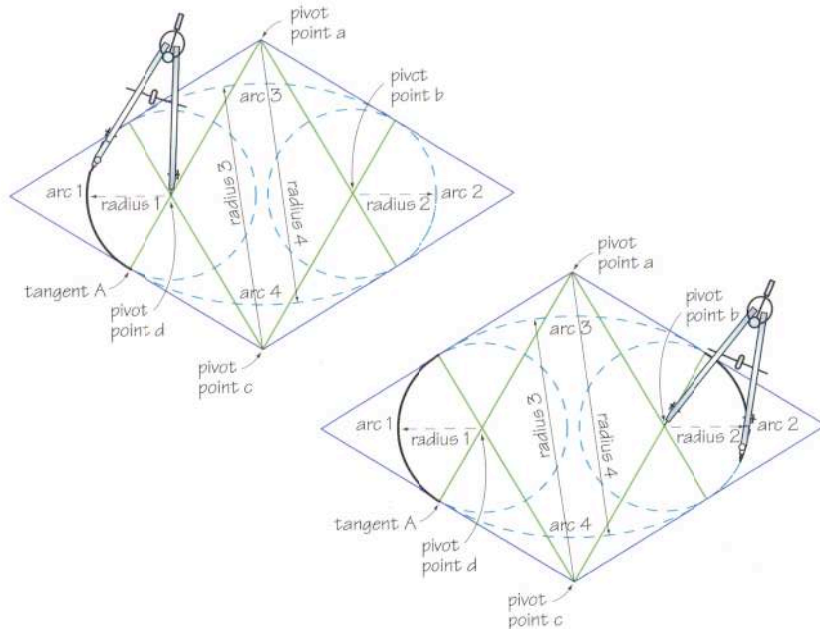
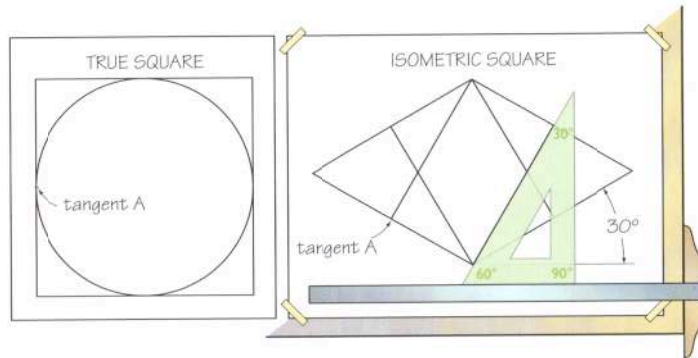

At these points, draw perpendicular lines to the sides of the isometric square, using a 60-degree triangle. The four intersections of the perpendicular lines (*a*, *b*, *c*, and *d*) will be the center from which four arcs can be drawn with a compass to complete the isometric circle.

The point where radius 1 meets radius 4 (*tangent A*) will be tangent to the isometric square. The radii will blend naturally, creating a smooth arc.

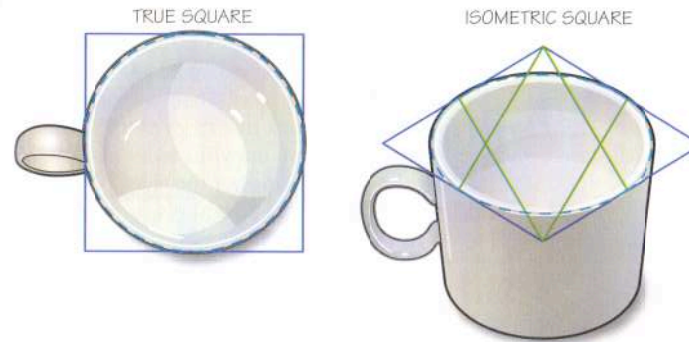
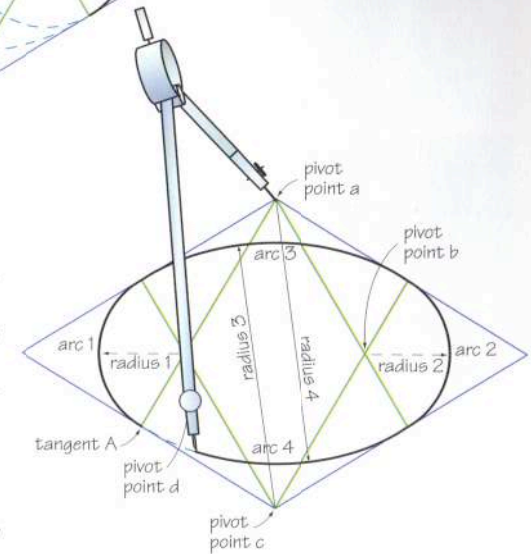

Perspective Drawing

Perspective drawing shows an object as it looks to the eye. In the example of railroad tracks mentioned earlier, a perspective drawing would show the two parallel rails coming together on the horizon, at what is called a *vanishing point*, just as the rails would in real life. Perspective drawings are often used in architectural drafting to give customers an idea of how a house or building will look before it is built. This kind of drawing makes it easier to visualize the finished structure than a simple floor plan could.

Perspective drawings are not just used in architecture, though. They can be helpful when drawing any sort of large object—say, a car or a complicated piece of machinery.

Most perspective drawings are drawn with a one-point or two-point perspective. The numbers refer to the number of vanishing points on the horizon.

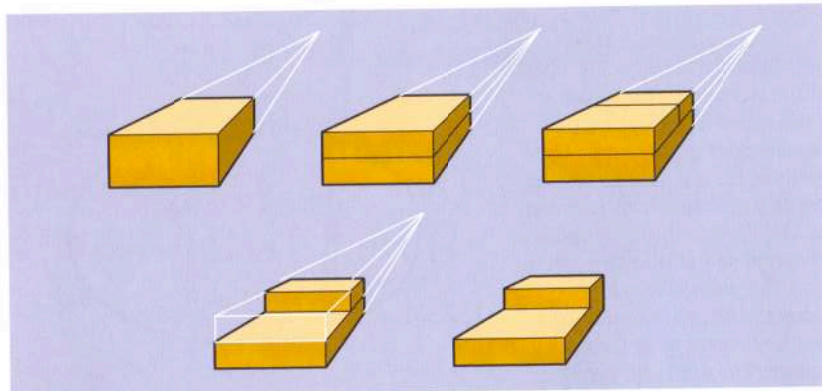

Laying out and blocking in a one-point perspective. Although perspective drawings are the easiest type of drawings for people to understand, they are often the most difficult to draw.

In the case of the *one-point perspective*, you draw the face of the object (say, a rectangular block) at its actual scale, just as you would in an orthographic projection. Then you draw guidelines from the corners of the block that meet at the same single point on the horizon. When you draw the sides along these guidelines, this creates a “shrinking” of the sides of the block as they recede from the front face toward the horizon. That shrinking is what makes the drawing look realistic.

More commonly used than a one-point perspective is the *two-point perspective*. Instead of starting with a straight-on view of the face of the block, this drawing starts with a corner view. From a straight vertical line representing the corner, the lines for the front and one side of the block are drawn out to *two* vanishing points on the horizon (see the illustration). This looks even more realistic than the one-point perspective.

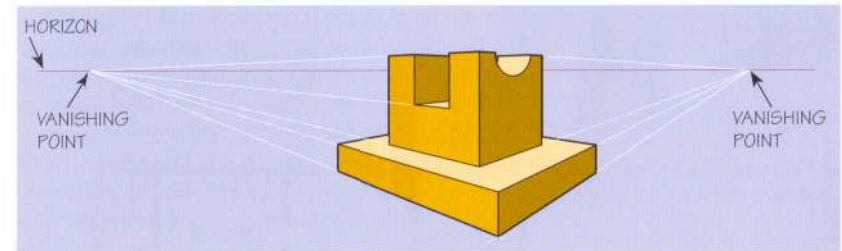

Example of a two-point perspective

Less commonly used are drawings with a *three-point perspective*, in which none of the lines are parallel. This perspective is often used when drawing skyscrapers, adding a third vanishing point on the horizon below the building. The effect of this is to make the building seem narrower near the ground, as though you were looking down toward street level from a point halfway up the side of a nearby building.

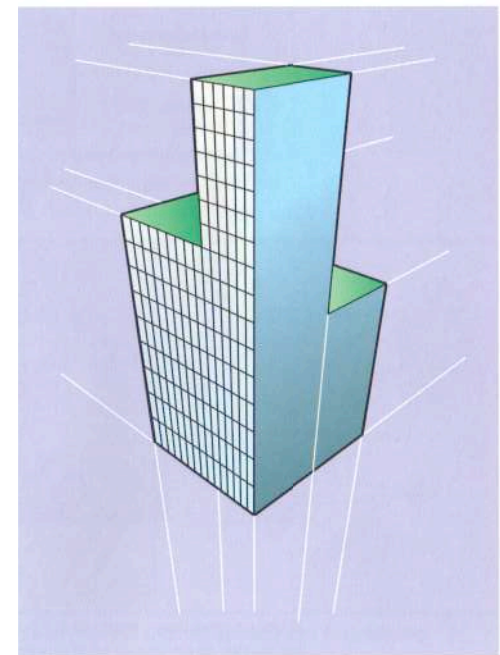

A three-point perspective adds realism when drawing objects such as tall structures.

The term *pictorial drawings* refers to various styles of drawing that show how an object might look in real life, that is, with three dimensions. Isometric drawings are pictorial. So are perspective drawings.

Pictorial Drawings

Architects create a type of pictorial drawings called *renderings*, which look like fine paintings of houses or buildings, complete with trees and other landscaping features. Renderings are often shown along with floor plans to give an idea of how a house looks from the outside as well as how big each room is.



Floor plan



If you draw lines from the "horizontal" lines of the house pictured, they meet at the *vanishing points*.

More Views

Still more types of drawings are commonly used, all of which have the same basic purpose: to communicate how an object should be put together.

Sectional Views. Sometimes an object, such as a car engine, has complicated internal features or a complex shape that does not allow the designer to show everything with just an outside view. In these cases, the designer might decide to draw a *sectional view*. It shows how the object would look if it were cut in half (or in smaller pieces). Sometimes a sectional drawing is referred to as a "cutaway view."

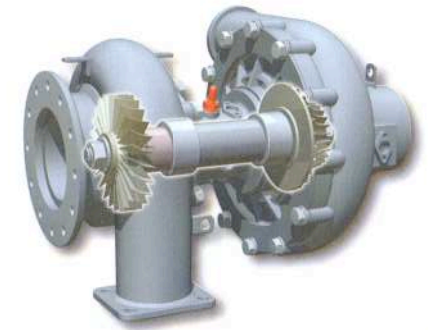

A sectional drawing or "cutaway view" shows objects inside a larger object.

Assembly Drawings. A drawing that shows how two or more parts of a product fit together is an *assembly drawing*. There are various types, showing different levels of detail. These range from layout drawings, showing the general design of the object, to working assembly drawings with exact specifications for manufacture. Often, one object will require several sheets of drawings. The first sheet is an assembly drawing showing the overall project, followed by several sheets of "subassembly drawings" showing how the component parts are put together. In the case of multiple sheets, the drafter will state in the title block how many sheets are included in the drawing set.

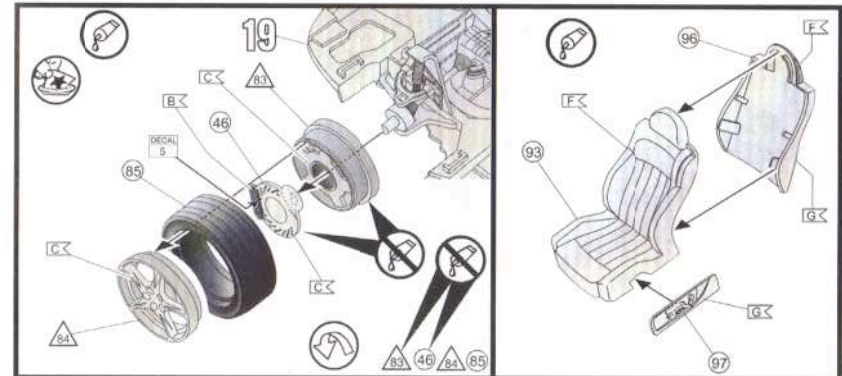

Good examples of assembly drawings are found in the instructions for putting together a model car.

Exploded Views. Another type of assembly drawing is the *exploded view*. It shows the various parts of a project pulled apart from one another but still in the same relative positions that they have when assembled. This helps you see how the individual parts look, while getting a good idea of how they fit together. This type of view is also common in instructions for model car kits.

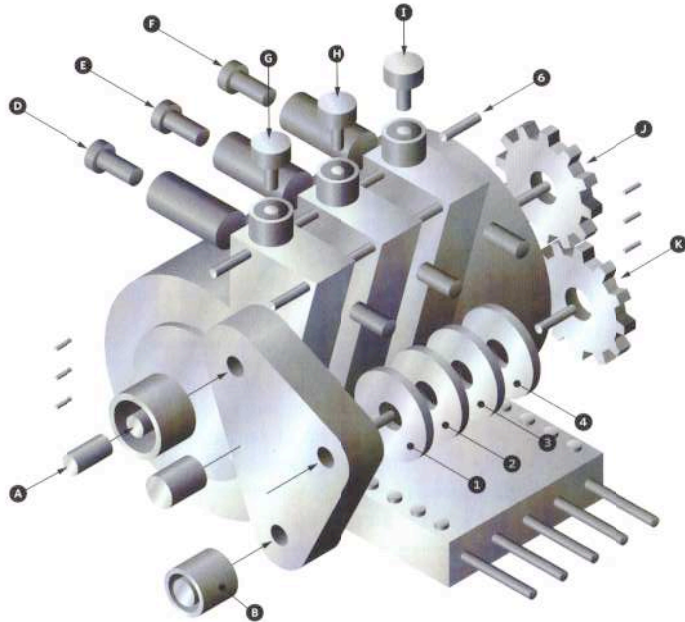

An exploded view shows the individual parts separated from one another but still in their correct relative positions.

Drawings sometimes contain a combination of styles rather than one style or view. An orthographic drawing, showing dimensions, might be combined with an isometric view of the object, which is easier to visualize. Likewise, a floor plan of a home design might be accompanied by a pictorial drawing, complete with landscaping, showing the finished project in the best possible light.

Different Plans

Here are some of the common types of plans that drafters create.

Floor Plans

The most basic and essential type of architectural plan is the floor plan. Imagine that you could look down at your home from above, with the roof and ceilings removed. This is the view that is reproduced in the floor plan. The floor plan shows each room, wall, door, and window in the house, as well as staircases, patios, decks, and other structures. In multistory houses, each floor has a separate plan.

Electrical Plans

An electrical plan starts with a copy of the floor plan, adding the appropriate symbols (discussed in the next chapter) to show where electrical services should be placed. All light fixtures, wall outlets, switches, cable TV outlets, ethernet connections, fiber-optic connections, and telephone connections are added to the floor plan using symbols.

You can draw a floor plan of your own home using only a tape measure, a pencil, and grid paper.

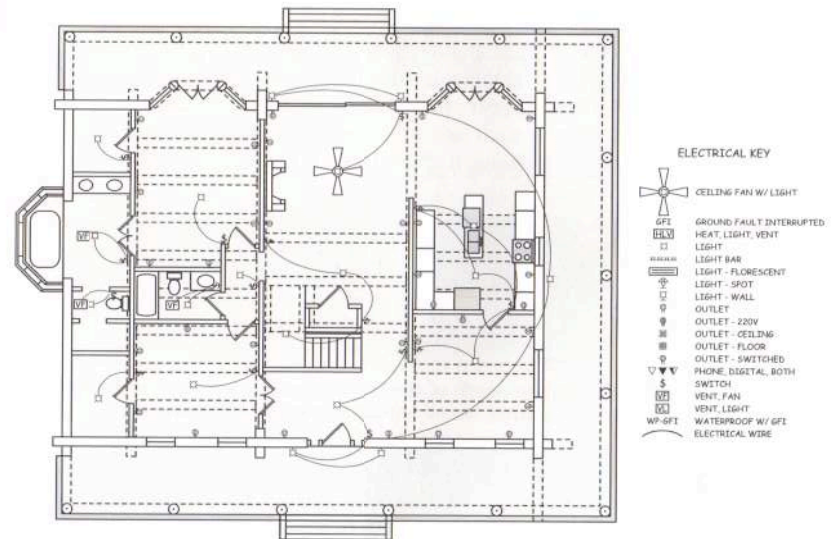

Electrical plan

Landscape Plans

Trees and shrubs add beauty and can have other benefits. Shade trees, for example, can help cool a house in a warm climate, while a row of trees or thick bushes can help insulate a house in a cold or windy climate.

The landscape plan shows the design of an entire property, not just the structure that sits on the property. This plan shows the landscaper where to place flower beds, shrubs, and trees. It is also useful in showing walkways, driveways, and the structure's relationship to other nearby buildings.



A landscape plan shows the location of trees, shrubs, flower beds, lawns, and walkways.

Elevation Views

Another type of architectural drawing is the *elevation view*, a type of orthographic drawing that shows details about a structure that do not appear on the floor plan. Generally, an elevation view is drawn for each side of the house. It shows the perspective of someone standing at ground level (rather than a bird's-eye view).



Items like the depth of the foundation, type of roof, and height from the ground are all shown in elevation drawings.

Elevation views are also sometimes drawn for interior (inside) walls, to show the layout of such features as built-in fireplaces, bookcases, and entertainment centers in a living room, or cabinetry and windows in a bathroom.

Electronics Drawings

Drawing plans of electronic devices and systems is increasingly important as computers and computer circuits find their way into more and more parts of our lives. These days, everything from an automobile engine to a greeting card can have a computer chip in it. Special symbols are used in electronics drawings, using standards set by industry groups such as the Institute of Electrical and Electronics Engineers.

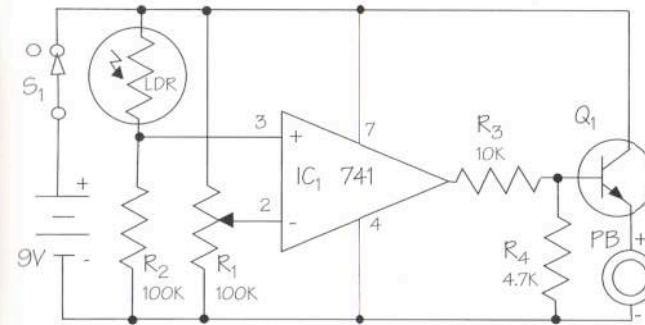

Electronics drawings include schematic diagrams (such as this one), block diagrams, logic diagrams, and wiring diagrams. Each has its own purpose and level of detail. For more about diagrams, see the *Electronics and Radio* merit badge pamphlets.

Different Formats

To clearly present the various views and plans, drafters use different types of formats. Although formats differ in style and content, all share a few things in common. They convey important information about the drawing on the sheet. This information commonly includes the drawing's name or number (or other means of identification), the date it was drawn, the designer's name, and the drawing scale. Other important information that is often included is the material used, company name or logo, approvals, and sheet number (for drawings that require more than one sheet).

On these pages are several sample formats used for different types of projects. Note the information contained in the title blocks in each example. Also notice that each format has a border and title block. No drawing is finished until the title block is added.

In this sense, the word "format" simply means a particular way of arranging and labeling standard elements in a drawing. Every company, or designer, uses its own favorite type of format.

For the Drafting merit badge, you will format two sheets of drawing paper with proper borders and title blocks. You will use one formatted sheet for your manual drawing project, and one sheet for your lettering project. No special type of paper is required, however, you may want to tape two 8½-by-11-inch sheets of paper together to make a more generous 11-by-17-inch drawing surface. If you have a little money to spend, you can find drafting tools and papers at most stores selling office, school, or art supplies. Standard sizes for professional quality papers are usually 17 by 24 inches or 24 by 36 inches.

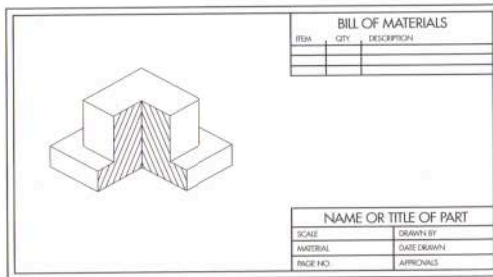

This format is used for drawing objects, such as machines or woodwork.

This format is used for making electrical drawings, such as electronic circuits.

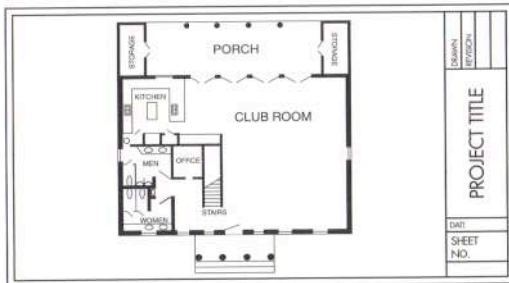
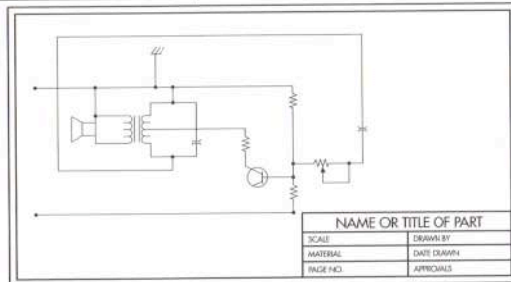

This format is used for architectural drawings of buildings, floor plans, etc.

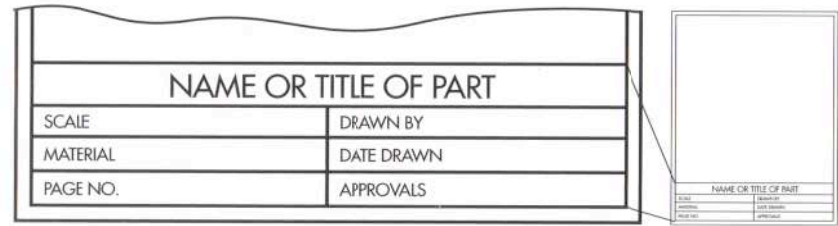

This format is used for lettering, for notes, or for drawing small parts. Use this format when you need to provide written information, such as how CAD has been used in the drawing. Use lettering rules when writing in this format.

Computer-Aided Drafting Software

For requirements 3 and 4, you will draw with the help of computer software. Ask your counselor's advice about software programs, where to find a program that fits your needs, and how to use it. Look at several options. For requirement 4 you are to discuss not only the software you use, but also other programs that are available.

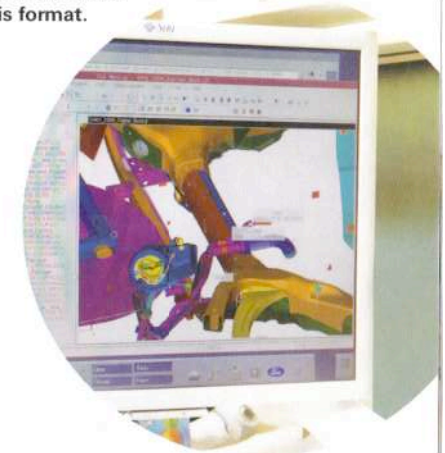

CAD (or CADD) Software Online

Many software programs are available on the Internet as "freeware" that will let you try computer-aided drafting or design. Search for the term "free CAD software."

A program available at this writing is Sketchup, a free download at <http://www.sketchup.com> that is widely used by students of architecture and design. The program will not allow you to do a professional drawing but does help you understand perspective and other drafting and design concepts. One fun exercise to do with the program is to create a 3-D model of your own house or apartment building. Be sure to use the tutorials that accompany the program.

Before downloading or installing any freeware or other software from the Internet, first get your parent's (and the computer owner's) permission.

You may get to try advanced or professional design software when you visit a place of business to meet requirement 6a.

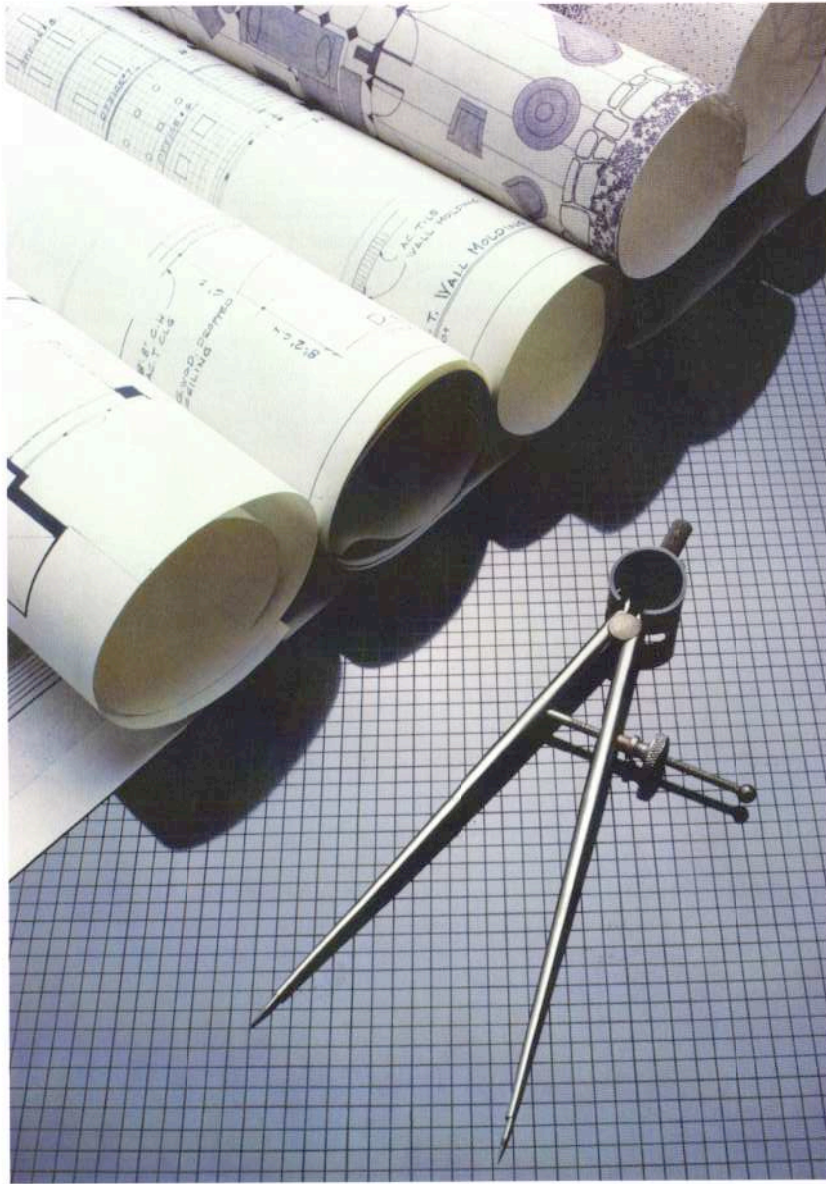

The Symbols of Drafting

Every industry has its own symbols that help its professionals. Electrical engineers have symbols for resistors and transistors; these are seldom used by architects. Architects use special symbols of their own—for doors, windows, and walls—for which mechanical engineers have little use. Mechanical engineers, in turn, have symbols for welding, drilling, and machine sections that are not often used in other professions.

Regardless of the exact symbols used, the purpose of them is the same: to allow you, the draftsperson, to properly communicate ideas to the professionals, who will be making objects from the drawings.

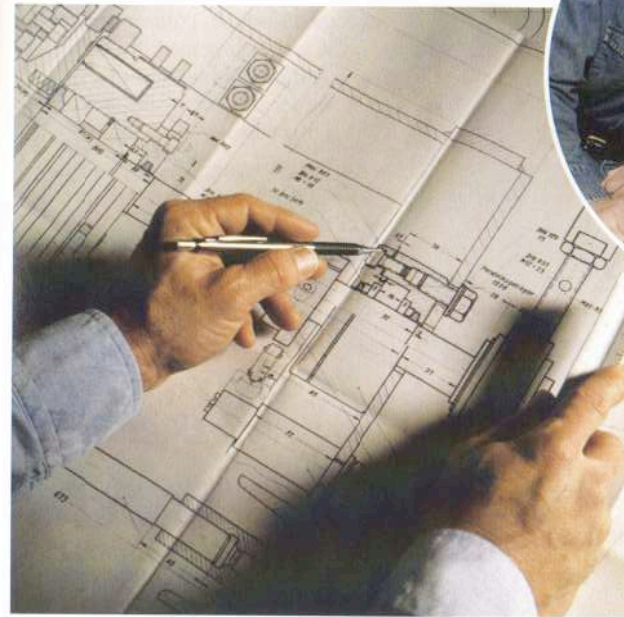

Lines and Symbols

Whether you are preparing architectural, mechanical, or electrical drawings, you must observe certain line *conventions* (the customary or agreed-upon way of doing things) used in all industries. A few of commonly used lines in drafting are shown here.

- Thin line.** For less important edges or edges beyond the section plane (for example, electrical outlets, windows, appliances, etc.).
- Medium line.** For primary edges (edges that are not directly visible).
- Thick line.** For object, or perimeter, edges (outside, visible edges).
- Dash-dot line.** Medium-weight line for the center line, boundary line, or other important line not actually in the object.
- Extension line.** Thin line not connected to the object; used to show the limits of a dimension.

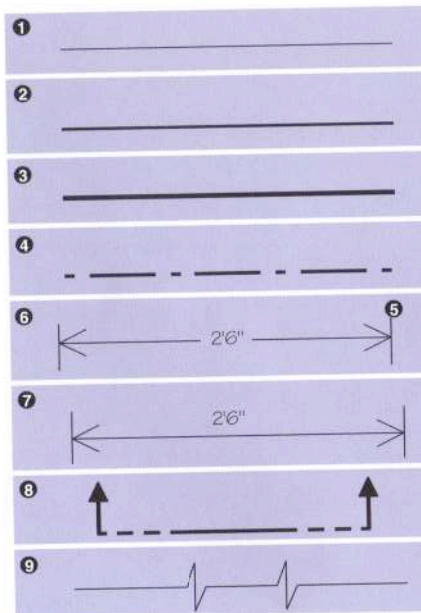

- Dimension line.** Thin line with arrow points touching the extension line and with a break in the middle for the dimension numeral (in a mechanical drawing), or
- Dimension line.** Thin line with dimension numerals on top of the line. This type of dimension line is more commonly used.
- Section line.** Similar to dash-dot line, but with two short dashes instead of a dot. Used when a section of an object is being drawn. Arrows indicate the view through which the section of an object was drawn.
- Breakline.** Used where the section view, or plan, is discontinued.

Architectural Symbols

- Light.** Ceiling- or wall-mounted.
- Duplex outlet.** Wall plug, 110 volts.
- Switch.** Wall-mounted, 110 volts.
- Special-purpose outlet.** Specify on the drawing which type the outlet represents (phone, alarm system, junction box, etc.).
- Floor drain.**
- Ceiling-mounted fluorescent light.** Specify the number of light tubes and their length (for example, four 48-inch tubes).
- Double-hung window.** Usually, the size is marked on the window's exterior.
- Door, exterior.** Specify size.
- Door, interior.** Specify size.
- Dimension.** Standard architectural dimension line. Note that diagonal hatch marks are used in the same way arrowheads are used in mechanical drafting.

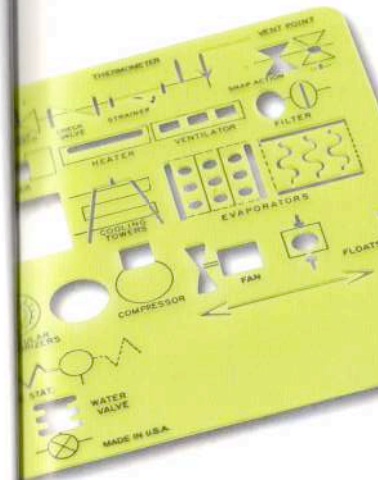
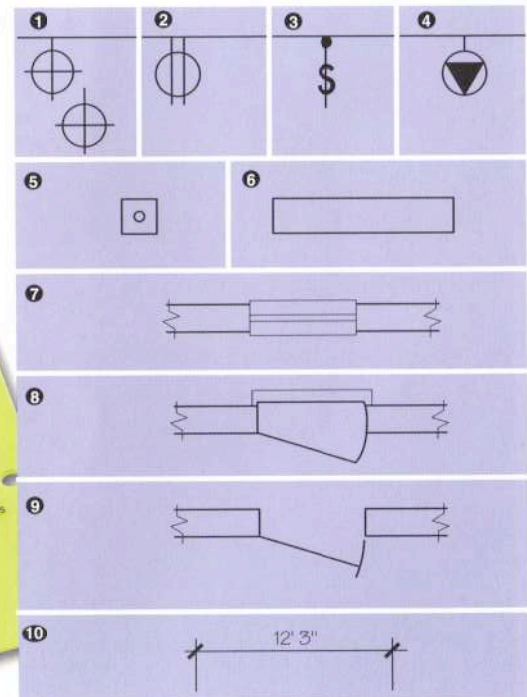

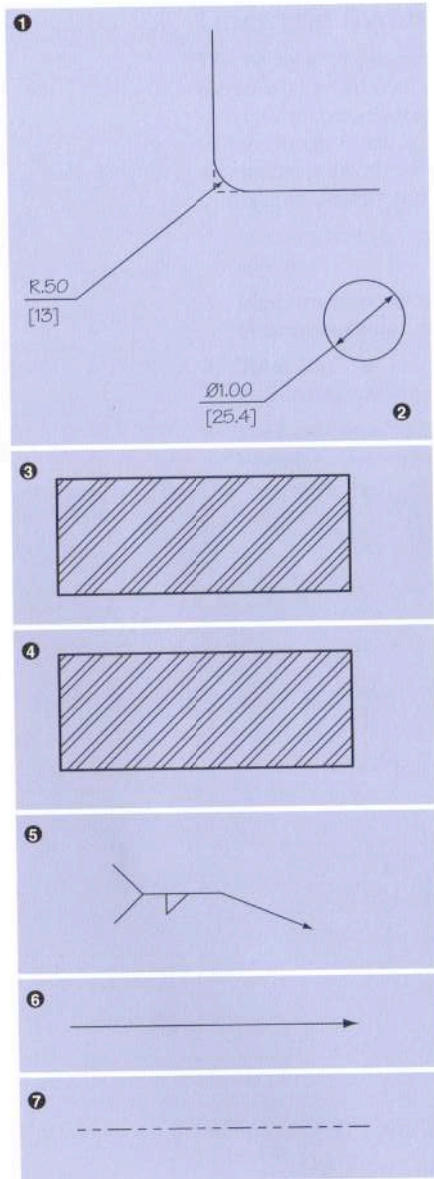

Mechanical Symbols

- 1. Radius arrow.** The letter R is used to designate radius. The *radius* of a circle is half the diameter; it is the distance from the center of a circle to the outside. The top number, above the line, expresses the radius in decimal inches; the bottom number, shown in square brackets, is the dimension in millimeters.
- 2. Diameter.** The \varnothing symbol indicates diameter. The letters DIA may also be used.
- 3. Section, plastic.** Indicates plastic section lines for plastic parts cut to show section views.
- 4. Section, steel.** Indicates steel section lines for steel parts cut to show section views.
- 5. Weld.** Indicates where standard *fillet welds* (welds with a triangular cross section) are to be made on metal parts.
- 6. Leader arrow.** The type of arrow-head used in mechanical drawings.
- 7. Phantom line.** Used to indicate the exterior of a part when less than the entire part is shown. (If only the front half of a car is drawn in detail, for example, phantom lines would be used to show the outline of the back of the car.)

Electronics Symbols

- 1. Earth ground.** Indicates where a circuit is to be connected to the ground.
- 2. Chassis ground.** Indicates where a circuit is to be connected to the chassis, or frame, of the electronic equipment.
- 3. Capacitor.**
- 4. Capacitor (polarized).**
- 5. Fuse.**
- 6. Resistor (fixed value).**
- 7. Resistor (variable resistance).**
- 8. Transistor.**
- 9. Switch (opened, or "off").**
- 10. Diode (semiconductor type).**
- 11. Loudspeaker.**
- 12. Transformer.**

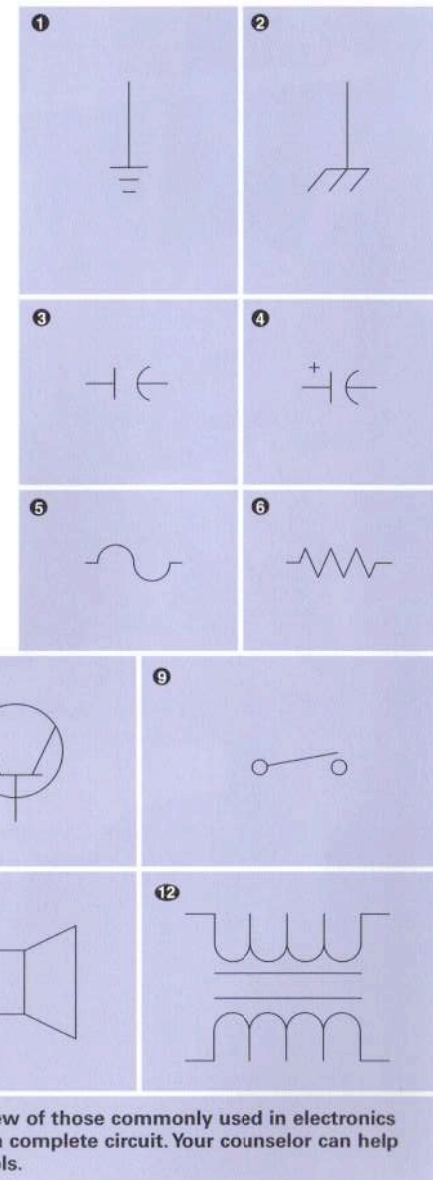

These electronics symbols are only a few of those commonly used in electronics drafting and are sufficient for drafting a complete circuit. Your counselor can help you with specialized electronics symbols.

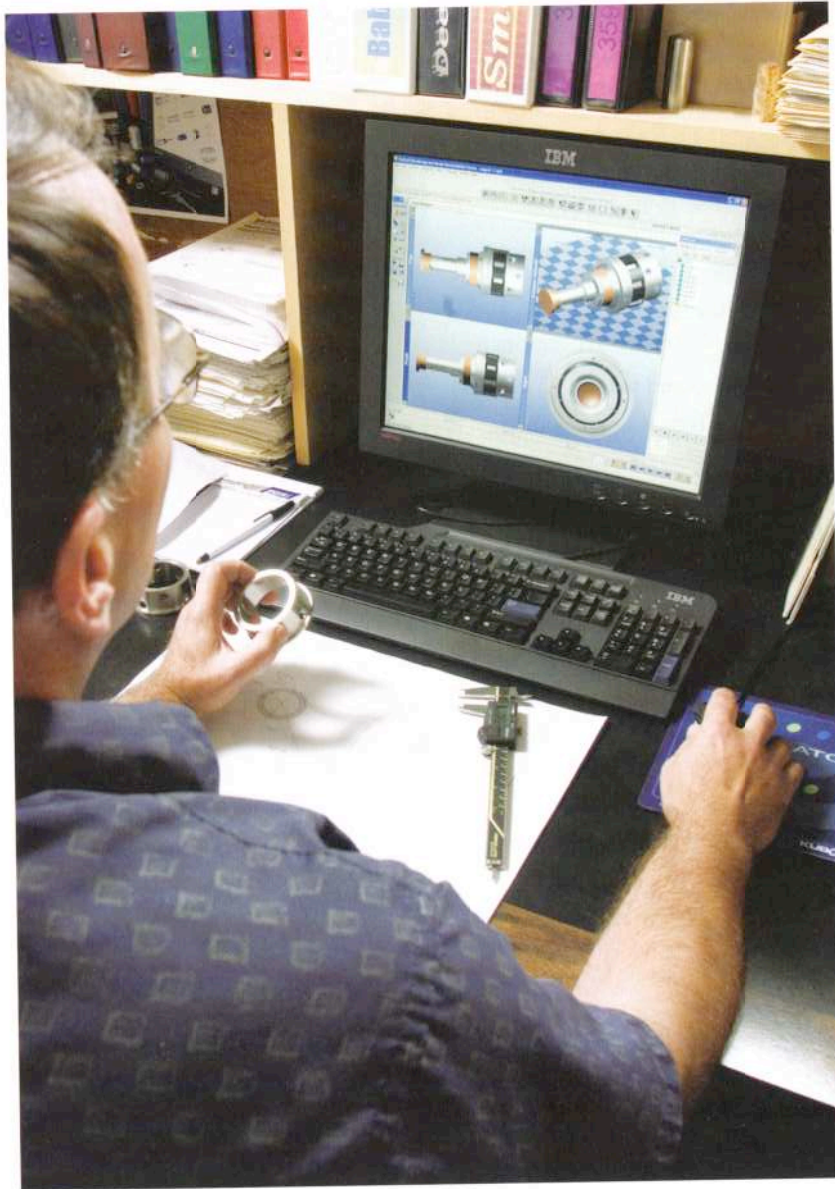

Careers in Drafting

As the technology of drafting has evolved, so have career opportunities in drafting. Drafters of the past spent several years in training, mostly on the job. They learned the trade from more experienced coworkers, and, in time, were experienced enough to teach newer employees themselves.

This system of on-the-job learning has mostly given way to college training in drafting and drawing. Today, many employers require a four-year degree before they will consider a person as a designer.

Depending on the position, designers of today may need to be knowledgeable about engineering and architecture, since they could be working closely with people in those fields and using many of the same tools.

Here are some of the titles and career opportunities found in drafting today:

Drafters

Drafters create technical drawings for industry, science, and engineering. Drafting skills are needed to support the many industries that require plans and drawings of steel, plastic, glass, wood, and electronics processes. Because drafting is closely tied to the fields in which it is used, there are many specialized drafting positions in which knowledge and training in the broader field are essential.

Aeronautical drafters draw plans used to build aircraft.

Architectural drafters draw plans for constructing houses, buildings, and other structures. These drafters may further specialize in a type of structure, such as homes or shopping malls.

Civil drafters draw plans used in big engineering projects, such as highways, dams, bridges, and sewage systems.

Electrical drafters draw wiring diagrams used to build electrical equipment and wiring in homes, buildings, and other structures.

Electronics drafters also draw wiring diagrams, but in addition they draw circuit boards and other schematics used in making electronic devices and components, such as personal music players and cell phones.

Mechanical drafters draw plans showing how to assemble machines.

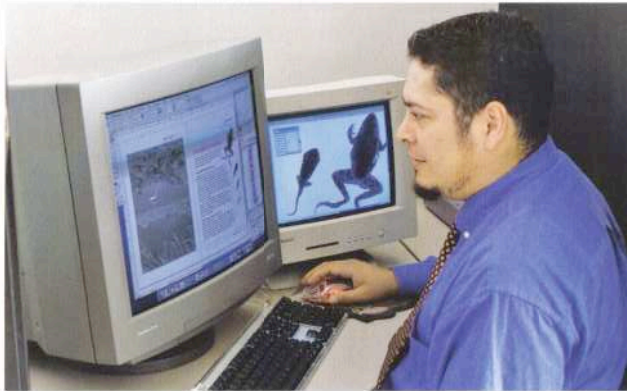

Related Careers

With modern drafters relying heavily on computer-aided drafting and design software, nowadays they are sometimes called *CADD operators*. Other positions also use drafting skills.

Engineering technicians help design, develop, test, and create various projects, products, or processes. They may assist engineers and scientists in a multitude of ways.

Graphic designers lay out books, magazines, and other print publications, as well as digital media. Graphic designers may be called *digital technicians*, since so much of their work deals with the technology of digital communications, involving not just drawings but also video, audio, and animation.

Illustrators create drawings, pictures, graphs, tables, and other kinds of images for publications and electronic media, sometimes in specialized fields of science, medicine, or engineering.

Cartographers create maps for business, industry, and government, both digitally and on paper.

Training for a Drafting Career

If you want to pursue a career in drafting, start by taking any specialized drafting course that may be offered in your high school. Take as many shop courses as you can to get experience in reading blueprints and plans and to learn about the craftsman's use of tools in creating the objects shown in the plans. Take drawing courses that may be offered by your school's art department.



After high school, you will continue your specialized training in drafting. Many drafting, engineering technician, graphic arts, and computer courses are offered by trade schools and community colleges. You will need to get trained in using particular CAD software programs. This training can come during coursework at college, on the job, or through private firms. Some forms of technical training taught in the armed forces can also be used in civilian drafting positions.

The more education you have, the more competitive you will be in the job market. Many employers require four-year degrees in design or related fields. Growth in the number of drafting positions available is expected to slow as more and more drafting work becomes computerized. However, the outlook is still good overall for drafters with a good education and a solid background in CADD, in addition to the traditional drafting skills.

Drafters need math skills.

Take as many science and math courses as possible, including geometry, algebra, trigonometry, and physics.

Drafting Resources

Scouting Literature

Architecture, Art, Computers, Engineering, Graphic Arts, Landscape Architecture, Model Design and Building, and Surveying merit badge pamphlets

For more information about Scouting-related resources, visit the BSA's online retail catalog (with your parent's permission) at <http://www.scoutstuff.org>.

Books

Bethune, James D. *Essentials of Drafting*. Prentice Hall, 1998.

French, Thomas E. *Mechanical Drawing: Board and CAD Techniques*. McGraw-Hill, 2002.

Giesecke, Frederick. *Technical Drawing I*. Prentice Hall, 2002.

Liebing, Ralph W. *Architectural Working Drawings*. Wiley, 1999.

Petroski, Henry. *Invention by Design: How Engineers Get From Thought to Thing*. Harvard University Press, 1998.

Ramsey, Charles G. *Architectural Graphic Standards*. Wiley, 2000.

Wakita, Osamu A. *The Professional Practice of Architectural Working Drawings*. Wiley, 2002.

Wallach, Paul R. *Fundamentals of Modern Drafting*. Delmar Learning, 2002.

Organizations and Web Sites

American Design Drafting Association

105 E. Main St.
Newbern, TN 38059
Telephone: 731-627-0802
Web site: <http://www.adda.org>

American Institute of Architects

1735 New York Ave., NW
Washington, DC 20006-5292
Telephone: 202-626-7300
Web site: <http://www.aia.org>

American Institute of Chemical Engineers

3 Park Ave.
New York, NY 10016-5991
Toll-free telephone: 800-242-4363
Web site: <http://www.aisc.org>

American Society of Architectural Illustrators

11756 W. Hopi St.
Avondale, AZ 85323
Telephone: 623-433-8782
Web site: <http://www.asai.org>

American Society of Civil Engineers

1801 Alexander Bell Drive
Reston, VA 20191
Toll-free telephone: 800-548-2723
Web site: <http://www.asce.org>

Junior Engineering Technical Society

1420 King St., Suite 405
Alexandria, VA 22314
Telephone: 703-548-5387
Web site: <http://www.jets.org>

National Society of Professional Engineers

1420 King St.
Alexandria, VA 22314
Telephone: 703-684-2800
Web site: <http://www.nspe.org>

Society of Automotive Engineers

400 Commonwealth Drive
Warrendale, PA 15096-0001
Telephone: 724-776-4841
Web site: <http://www.sae.org>

Society of Manufacturing Engineers

1 SME Drive
P.O. Box 930
Dearborn, MI 48121
Toll-free telephone: 800-733-4763
Web site: <http://www.sme.org>

U.S. Department of Labor

Bureau of Labor Statistics
Occupational Outlook
Handbook: "Drafters"
Web site:
<http://www.bls.gov/oco/ocos111.htm>

Acknowledgments

The Boy Scouts of America gives special thanks to avid Scouter David Oakley, Lincoln Park, Michigan, for his support, subject expertise, and patience with this revision of the *Drafting* merit badge pamphlet. Mr. Oakley remained a constant and invaluable resource throughout this lengthy project.

We greatly appreciate Ford Motor Company for allowing us to have a photo shoot at its facility in Dearborn, Michigan. Thanks also to Adam Wendl and David Wendl of Troop 1052, Dearborn, Michigan, for their assistance with photography. We appreciate Jim Hamblin, brake engineer, Ford Motor Company, for his assistance with the isometric section. Thanks to Roland Kuhleman, instructor, architecture/engineering graphics and computer applications, Haltom (Texas) High School, Birdville Independent School District, for his input and subject expertise.

The Boy Scouts of America is grateful to Scott S. Stuckey for updating this edition of the *Drafting* merit badge pamphlet. Mr. Stuckey is a senior editor at *National Geographic Traveler* magazine and is the former editor of *Boys' Life* magazine.

We appreciate the Quicklist Consulting Committee of the Association for Library Service to Children, a division of the American Library Association, for its assistance with updating the resources section of this merit badge pamphlet.

Photos and Illustration Credits

Richard B. Ferrier, FAIA, courtesy—
page 30

©2007 iStock International Inc.—
pages 45 (*top*) and 46

NASA, courtesy—page 24

Nikon Inc., courtesy—page 33 (*all*)

©Photos.com—cover (*blueprints, computer monitor, drafting table, compass, ruler, template*); pages 5–7 (*all*), 8 (*top, both on bottom right*), 9, 12, 23 (*top*), 36 (*bottom*), 52–53 (*all*), and 55 (*left*)

Revell Inc., used with permission—
pages 32 and 45 (*bottom both*)

Wikipedia.org, courtesy—cover (*graphics tablet*); pages 8 (*bottom left*) and 16 (*bottom*)

Wikipedia.org/Craig Spurrier, courtesy—
cover (*styluses at top right*) and
page 16 (*top*)

All other photos and illustrations
not mentioned above are the property
of or are protected by the Boy Scouts
of America.

John McDearmon—pages 17, 22
(*both*), 25, 28 (*both*), 34, 36 (*top*),
37–44 (*all*), 47–50 (*all*), 51 (*top*),
54 (*all*), 55 (*illustrations*), and
56–57 (*all*)

Randy Piland—pages 11 (*all*), 14, 20,
58, and 61

MERIT BADGE LIBRARY

Though intended as an aid to Boy Scouts, Varsity Scouts, and qualified Venturers in meeting merit badge requirements, these pamphlets are of general interest and are made available by many schools and public libraries. The latest revision date of each pamphlet might not correspond with the copyright date shown below, because this list is corrected only once a year, in January. Any number of merit badge pamphlets may be revised throughout the year; others are simply reprinted until a revision becomes necessary.

If a Scout has already started working on a merit badge when a new edition for that pamphlet is introduced, he should continue to use the same merit badge pamphlet to earn the badge. He should fulfill the requirements listed in the pamphlet he was using when he began. In other words, the Scout need not start all over again with the new pamphlet and possibly revised requirements.

Merit Badge Pamphlet	Year	Merit Badge Pamphlet	Year	Merit Badge Pamphlet	Year
American Business	2002	Engineering	2000	Photography	2005
American Cultures	2005	Entrepreneurship	2006	Pioneering	2006
American Heritage	2005	Environmental Science	2006	Plant Science	2005
American Labor	2006	Family Life	2005	Plumbing	2004
Animal Science	2006	Farm Mechanics	1997	Pottery	2002
Archaeology	2006	Fingerprinting	2003	Public Health	2005
Archery	2004	Fire Safety	2004	Public Speaking	2002
Architecture	2004	First Aid	2007	Pulp and Paper	2006
Art	2006	Fish and Wildlife		Radio	2001
Astronomy	2004	Management	2004	Railroading	2003
Athletics	2006	Fishing	2002	Reading	2003
Auto Mechanics	2000	Fly-Fishing	2002	Reptile and	
Aviation	2006	Forestry	2005	Amphibian Study	2005
Backpacking	2007	Gardening	2002	Rifle Shooting	2001
Basketry	2003	Genealogy	2005	Rowing	2006
Bird Study	2005	Geology	2005	Safety	2006
Bugling (<i>see Music</i>)		Golf	2002	Salesmanship	2003
Camping	2005	Graphic Arts	2006	Scholarship	2004
Canoeing	2004	Hiking	2007	Sculpture	2007
Chemistry	2004	Home Repairs	2002	Shotgun Shooting	2005
Cinematography	2001	Horsemanship	2004	Skating	2005
Citizenship in the		Indian Lore	2003	Small-Boat Sailing	2004
Community	2005	Insect Study	2002	Snow Sports	2007
Citizenship in the Nation	2005	Journalism	2006	Soil and Water	
Citizenship in the World	2005	Landscape Architecture	2002	Conservation	2004
Climbing	2006	Law	2003	Space Exploration	2004
Coin Collecting	2002	Leatherwork	2002	Sports	2006
Collections	2003	Lifesaving	2001	Stamp Collecting	2007
Communications	2003	Mammal Study	2003	Surveying	2004
Composite Materials	2006	Medicine	2002	Swimming	2002
Computers	2005	Metalwork	2007	Textile	2003
Cooking	2007	Model Design and Building	2003	Theater	2005
Crime Prevention	2005	Motorboating	1992	Traffic Safety	2006
Cyding	2003	Music and Bugling	2003	Truck Transportation	2005
Dentistry	2006	Nature	2003	Veterinary Medicine	2005
Disabilities Awareness	2005	Nuclear Science	2004	Water Sports	2007
Dog Care	2003	Oceanography	2003	Weather	2006
Drafting	1993	Orienteering	2003	Whitewater	2005
Electricity	2004	Painting	2002	Wilderness Survival	2007
Electronics	2004	Personal Fitness	2006	Wood Carving	2006
Emergency Preparedness	2003	Personal Management	2003	Woodwork	2003
Energy	2005	Pets	2005		

BOY SCOUTS OF AMERICA • SUPPLY DIVISION**NATIONAL DISTRIBUTION CENTER**

2109 Westinghouse Boulevard
P.O. Box 7143
Charlotte, NC 28241-7143

www.scoutstuff.org

DIRECT MAIL CENTER

P.O. Box 909
Pineville, NC 28134-0909
For fast credit card orders—

VISA, MasterCard, American Express—
call BSA operators toll-free
1-800-323-0732