



HOW TO USE THIS PAMPHLET

The secret to successfully earning a merit badge is for you to use both the pamphlet and the suggestions of your counselor.

Your counselor can be as important to you as a coach is to an athlete. Use all of the resources your counselor can make available to you. This may be the best chance you will have to learn about this particular subject. Make it count.

If you or your counselor feels that any information in this pamphlet is incorrect, please let us know. Please state your source of information.

Merit badge pamphlets are reprinted annually and requirements updated regularly. Your suggestions for improvement are welcome.

Send comments along with a brief statement about yourself to Boy Scout Division • Boy Scouts of America • 1325 West Walnut Hill Lane • P.O. Box 152079 • Irving, TX 75015-2079.

WHO PAYS FOR THIS PAMPHLET?

This merit badge pamphlet is one in a series of more than 100 covering all kinds of hobby and career subjects. It is made available for you to buy as a service of the national and local councils, Boy Scouts of America. The costs of the development, writing, and editing of the merit badge pamphlets are paid for by the Boy Scouts of America in order to bring you the best book at a reasonable price.

BOY SCOUTS OF AMERICA
MERIT BADGE SERIES

RAILROADING



BOY SCOUTS  OF AMERICA®

Requirements

1. Do THREE of the following:
 - a. Name three types of modern freight trains. Explain why unit trains are more efficient than mixed freight trains.
 - b. Name one class I or regional railroad. Explain what major cities it serves, the locations of major terminals, service facilities and crew change points, and the major commodities it carries.
 - c. Using models or pictures, identify 10 types of railroad freight or passenger cars. Explain the purpose of each type of car.
 - d. Explain how a modern diesel or electric locomotive develops power. Explain the terms dynamic braking and radial steering trucks.
2. Do the following:
 - a. Explain the purpose and formation of Amtrak. Explain, by the use of a timetable, a plan for making a trip by rail between two cities at least 500 miles apart. List the times of departure and arrival at your destination, the train number and name, and the type of service you want.
 - b. List and explain the various forms of public/mass transit using rail.
3. Do ONE of the following:
 - a. Name four departments of a railroad company. Describe what each department does.
 - b. Tell about the opportunities in railroading that interest you most and why.
 - c. Name four rail support industries. Describe the function of each one.
4. Explain the purpose of Operation Lifesaver and its mission.
5. Do THREE of the following:
 - a. List five safety precautions that help make trains safer for workers and passengers.
 - b. Explain to your merit badge counselor why railroad rights-of-way are important for safety.
 - c. List 10 safety tips to remember when you are near a railroad track (either on the ground or on a station platform) or aboard a train.
 - d. Tell your counselor about the guidelines for conduct that should be followed when you are near or on railroad property. Explain the dangers of trespassing on railroad property.
 - e. Tell what an automobile driver can do to safely operate a car at grade crossings, and list three things an automobile driver should never do at a grade crossing.
 - f. Tell how to report a malfunction of grade crossing warning devices.
 - g. List safety precautions a pedestrian should follow at a public crossing.
6. Explain the appearance and meaning of the following warning signs and devices: advance warning sign, pavement markings, crossbucks, flashing red lights, crossing gates.
7. Do EACH of the following:
 - a. Explain how railroad signals operate and show two basic signal types using color or configuration.
 - b. Explain the meaning of three horn signals.
 - c. Describe a way to signal a train for an emergency stop.
 - d. Explain the use and function of the EOTD (end-of-train device), or FRED (flashing rear end device), used on the last car of most trains.
8. Select ONE of the following special-interest areas and complete the requirements.
 - a. Model Railroading
With your parent's and counselor's approval, do TWO of the following:
 - d. With your parent's and counselor's approval, interview someone employed in the rail industry. Learn what that person does and how this person became interested in railroading. Find out what type of schooling and training are required for this position.

- (1) Draw a layout of your own model railroad or one that could be built in your home. Design a point-to-point track or loop with different routings. Include one of the following: turnaround or terminal or yard or siding.
- (2) Build one model railroad car kit or one locomotive kit.
- (3) Name the scale of four popular model railroad gauges. Identify the scale of four model cars or locomotives.
- (4) Locate the Web site of four model railroad-related manufacturers or magazine publishers. Print information on their products and services and discuss the information with your counselor.
- (5) Build one railroad structure (from scratch or using a kit), paint and weather the structure, mount it on your layout or diorama, and make the surrounding area on the diorama scenic.
- (6) Alone or with others, build a model railroad or modular layout including ballast and scenery. Make electrical connections and operate a train. Describe what you enjoyed most.
- (7) Participate in a switching contest on a timesaver layout and record your time.

b. Railfanning

With your parent's and counselor's approval, do TWO of the following:

- (1) Visit a railroad museum, historical display, or a prototype railroad-sponsored public event. With permission, photograph, videotape, or sketch items of interest. Explain what you saw and describe your photos, sketches, or videotape.
- (2) Purchase tickets and ride a scenic or historic railroad. Under supervision, photograph the equipment and discuss with your counselor the historic significance of the operation.
- (3) Locate the Web site of four rail historical groups, then find information on the history of the rail preservation operations and purpose of each group. Talk with a member of one of the groups and find out how you might help.
- (4) Plan a trip by rail between two points. Obtain a schedule and explain when the train should arrive at two intermediate points. Purchase the tickets and make the trip. Explain to your counselor what you saw.

Contents

A Brief History of American Railroading	7
Modern Railroads	13
Signals	30
Safety First	34
Railfanning	41
Careers in Railroading	47
Model Railroading	49
Resources About Railroading	61



Unit coal train, Burlington Northern and Santa Fe



A Brief History of American Railroading

At the turn of the 19th century, travel over land in the United States was slower than it had been in ancient Rome. The Romans had surfaced most of their roads with stone and other hard materials to make travel by horse-drawn wagon and chariots much easier. The dirt roads of Colonial America were far more primitive and filled with mud each time it rained. The lack of bridges forced people to go out of their way to cross rivers. Vehicles drawn by animals traveled about as fast as a human could walk. But the coming of the railroad changed all this.

On July 4, 1828, Charles Carroll—the last surviving signer of the Declaration of Independence—laid the foundation for what would become the Baltimore and Ohio Rail Road. Passengers could ride a horse-drawn railcar for 13 miles to Ellicott's Mills, Maryland. This was the nation's first *common carrier*, or public transportation, of freight and passengers by rail on a regular schedule.

Soon it became evident that steam was a more practical form of power than animals. Economics and the Industrial Revolution triggered and quickly stimulated the infant railroading industry. From the mines, forests, and farms to factories and markets, railroads hauled all kinds of products: coal, iron ore, timber, cattle, grain, and finished goods.

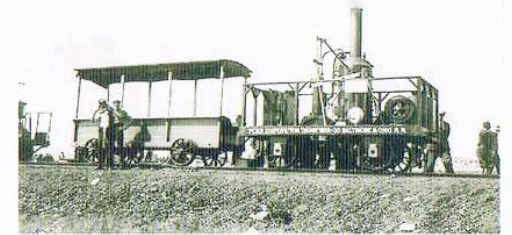

By 1830, Peter Cooper, an inventor from New York, completed work on his revolutionary invention for replacing horsepower with steam. The Tom Thumb, an experimental steam locomotive, never got beyond the test stage, but it paved the way for more advanced locomotives.

The California gold rush of 1849 increased public demand for coast-to-coast rail connections. Previously, railroad construction averaged 316 miles of track per year. But in the 1850s, the average jumped to 2,000 miles per year. By the time the U.S. Civil War started in 1861, more than 30,000 miles of track had been laid, almost as much as in all the rest of the world.

Industrialism swept through England in the 18th century. However, the Industrial Revolution did not occur in the United States until the early 19th century. This is when people began to invent and use machines to do work that previously had been done by hand, increasing productivity and efficiency.

By 1836, the Baltimore and Ohio Rail Road had reached Harper's Ferry, Virginia (there was no West Virginia until 1863), with a 37-mile line into Washington, D.C. Sixteen years later, these rails had extended to the Ohio River at Wheeling, Virginia, opening up what would soon become a trade route to the West.

During these early years the nation's rail system expanded along the Atlantic Coast from Portsmouth, New Hampshire, to the Carolina states. But it wasn't possible to ride a train or ship goods all that distance by rail. People still relied on stage-coaches, freight wagons, and coastal steamships. However, within six years of the founding of the Baltimore and Ohio Rail Road, 200 rail lines formed in America.

Some railroad companies established different *gauges* (distances between the inside edges of the rails) for their own tracks, making it impossible for railcars to pass from one railroad to another. People soon recognized the need for a uniform gauge. In preparation for the building of the Transcontinental Railroad, President Abraham Lincoln ordered that *standard gauge* should be 4 feet, 8½ inches. Many think this unusual measurement, still used today, is a throwback to the width of Roman chariot wheels. Britain ultimately adopted the same measurement as its own standard gauge for wagon and carriage wheels, and later railroad equipment. Many early locomotives in America were British-built, so it made sense to accommodate this wheel width in the United States.



The Transcontinental Railroad Unites a Young Nation

In an effort to bring the nation together by connecting the East to the West, President Abraham Lincoln, on July 1, 1862, commissioned the Union Pacific Rail Road to start laying tracks westward from Omaha, Nebraska. He also commissioned the Central Pacific Railroad to lay tracks eastward from Sacramento, California. The two railroad tracks were to meet somewhere in between at an undecided location. The track would cover a total distance of 1,780 miles.

After three years, only 40 miles of track had been laid. Even though Congress had allocated \$48,000 per completed mile of track as an incentive to each railroad, fighting between the North and South diverted attention. The U.S. Civil War of 1861–65 became the world's first armed conflict to use railroads, which underscored the growing importance of this new mode of transportation.

The Trans-continental Railroad was the most massive civil works project in history since the Great Wall of China. It would remain so until the digging of the Panama Canal early in the 20th century.

Transcontinental Railroad workers received from two to four dollars per day for backbreaking 12-hour shifts, an excellent wage for that time. A man's pay depended upon the kind of work he was hired to do. Laborers from all over came here for the high wages, the prospect of steady work, and a chance to stay after the rail line was completed. Most came from Ireland (where the potato famine had forced many families to the edge of starvation), Germany, Great Britain, Central America, and especially China, where as many as 7,000 laborers were recruited by the Central Pacific Railroad. Many second and third generation Americans laid track as well: Mormons, Civil War soldiers returning home, freed blacks who had been slaves, and American Indians.

The construction crews worked so hard near the end of the lines that they actually bypassed each other in their haste to outperform their rival crew. During one astounding day, almost two weeks before the two crews met, the workers laid more than 10 miles of track, a record that stands to this day. After the tracks from east and west were joined at Promontory Summit, Utah, on May 10, 1869, a golden spike was driven to symbolize the now correctly named *United States of America*.

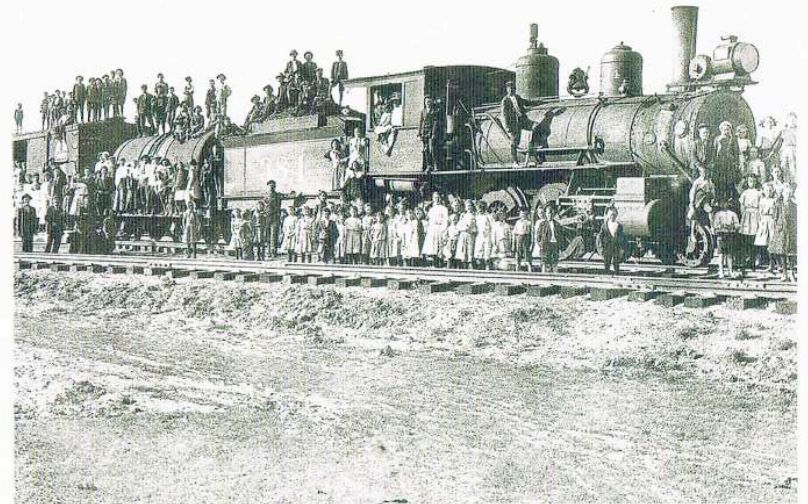

By the 1800s, with the introduction of the steam locomotive and rapid growth of railways, travel by train became more accessible to the general population.

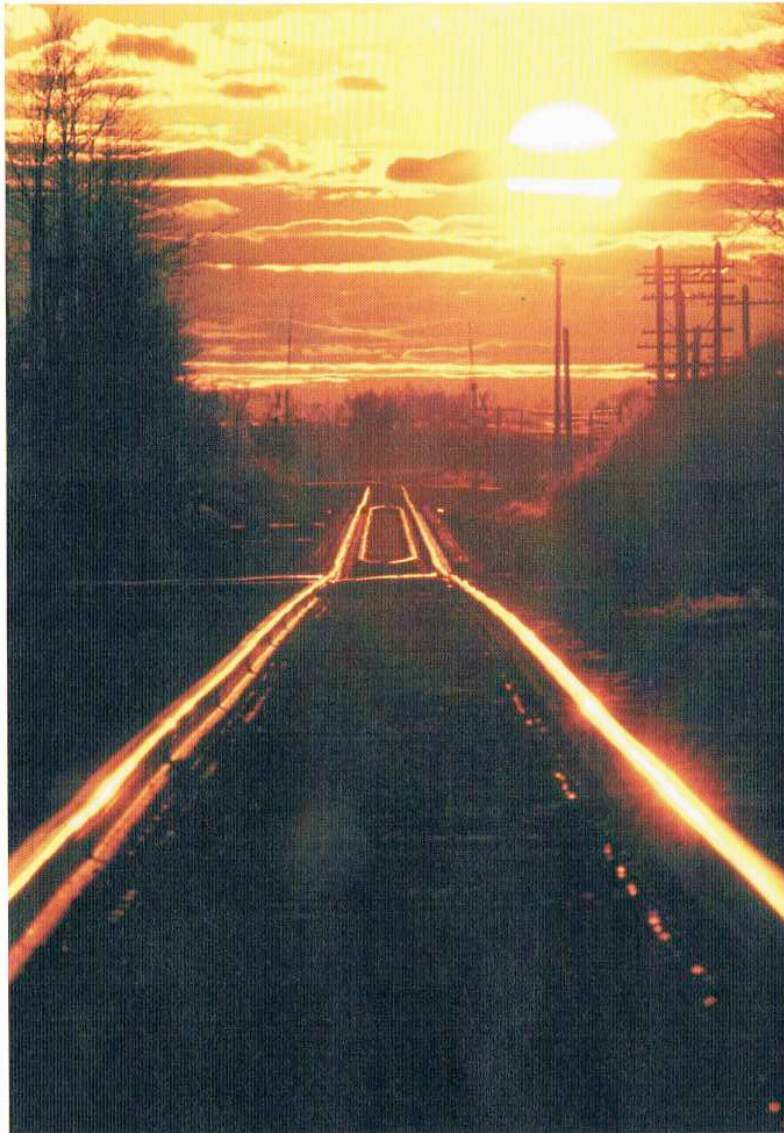

Modern Railroads

Railroads, with their low *rolling resistance*, offer the most efficient and cost-effective way to haul passengers and heavy freight long distances over land. It takes far less energy and fewer workers to operate a multi-car train than the equivalent number of highway trucks. The high labor efficiency comes from the fact that numerous carloads traveling along a guideway in close order need only one “driver.”

Railroads transport freight and passengers over land in steel-wheeled cars directed along fixed-guide paths. The rails, made up of two long, heavy bars of steel each shaped like an inverted “T,” may be set upon wood, concrete, steel, or composition *cross ties* embedded in crushed stone called *ballast*. Or their guideways may be elevated above or buried below ground.

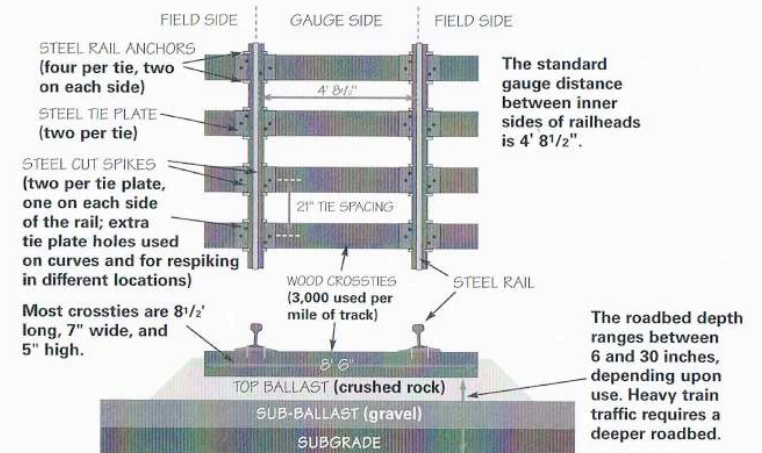

Structure of a railroad track

A simple physics principle, known as *rolling resistance*, establishes that hard wheels roll with less effort over hard surfaces than soft wheels do over softer surfaces. To test this principle, roll a golf ball over a hardwood floor. Then roll a foam rubber ball of the same size with the same force over carpeting. Which rolls easier and goes farther?

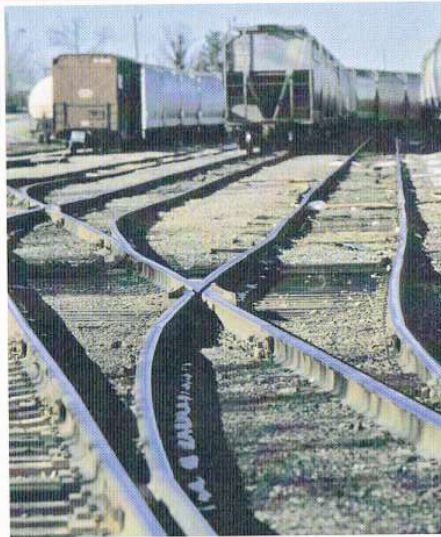

Various track configurations give flexibility to train movement. The most common include the *turnout*. At the turnout *switch* is a steel *frog*, a channeled device at the intersection of two tracks that allows the wheel flanges of a rail car to cross over from one track to another. For more information about track configurations, refer to the "Model Railroading" section in this pamphlet.

The *switch* diverts wheels from one track to the other when switch points are shifted.

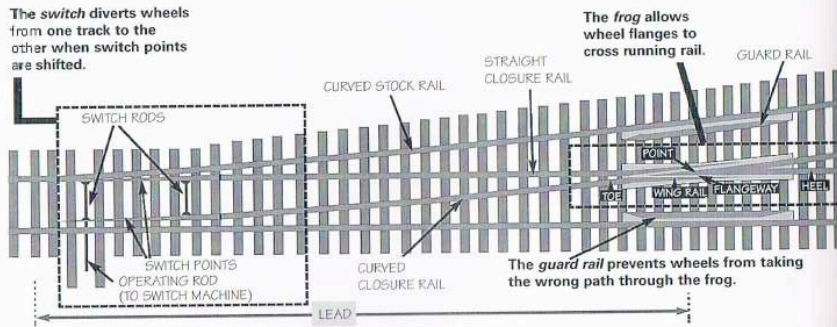

Parts of a turnout

Unlike other transportation companies and industries, railroads must build, maintain, monitor, and pay property taxes and associated operating costs on their rights-of-way. Railroads that lease their rolling stock, operate over another company's track, share loading facilities with another carrier, or contract with employees of another company to run their own trains may not have all these costs.

Freight Trains

Trains are categorized according to the freight they haul and the cars they operate.

Unit trains haul a single freight or commodity such as coal, automobiles, gravel, or grain. They use the same type of car to run between two points—with no loading or unloading stops in between. These trains usually deliver their freight to one destination, saving a lot of time because they don't have to be sorted in a classification yard and redirected.

Mixed trains, or general merchandise trains, carry a variety of freight in different types of railcars. The individual cars are ultimately headed for different destinations, so the mixed train usually goes through a classification yard.

Intermodal trains haul standardized, space-saving containers and trailers that are also carried on trucks and ships. This method of shipping is called *containerization*, a way that saves shippers considerable time and handling expense while protecting the cargo from the weather, damage, and theft. Intermodal containers can move as singles loaded on flatcars, or as *double-stacks* with containers stacked two-high.

Refer to the timesaver switching game in the "Model Railroading" section to see how freight trains are sorted in a classification yard.



Every day a unit train of refrigerated boxcars leaves Florida, headed for New Jersey with thousands of gallons of fruit juice on board.

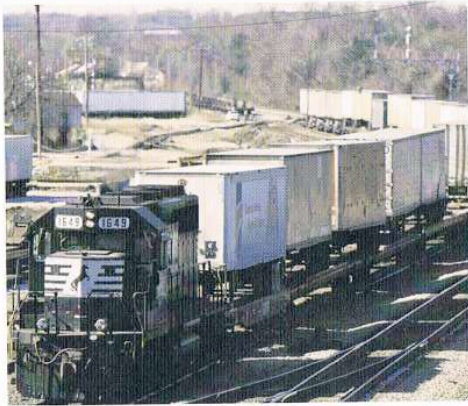

Highway truck trailers are carried in *piggyback* formation on flatcars, much like the way circus and farm wagon trains had traveled in earlier years.



Greenbrier Maxi-Stack AP®, an all-purpose double-stack car



For containerized cargo, flatcars are frequently loaded and unloaded by an intermodal crane, which straddles the train.

Some uniquely constructed intermodal trailers called *RoadRailers*® travel the nation's highways on standard trailer tires. At intermodal terminals, their rubber-tired highway wheels are lifted to allow their rail wheels onto the tracks. *RoadRailers*® carry mail, express, and other high-priority or perishable freight. One locomotive can easily haul 100 *RoadRailers*®.

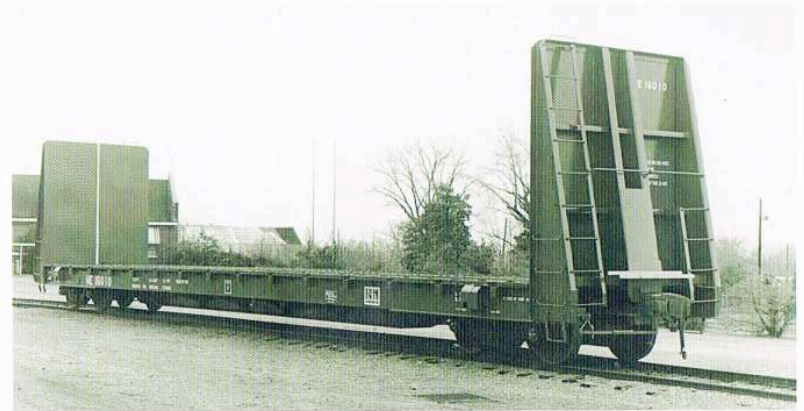

Bulkhead flatcar

Specialized Freight Cars

Shippers use different kinds of railroad cars depending on the type of cargo, or *lading*, to be delivered and the loading/unloading facilities available. *Flatcars* are platforms used for carrying intermodal containers and piggyback trailers. They also carry other freight, including large electrical generators and transformers, bulky pipe sections, and even military weapons. Flatcars can be unloaded by intermodal cranes or from the side by a large overhead container forklift. They come in several variations: *all-purpose*, which is flat (flush) all the way across; *center beam bulkhead*, with a supporting bulkhead that runs down the center from end to end; *bulkhead*, with sturdy walls at either end; and *depressed-center*, with a depression in the platform for lowering double-stack loads enough to clear bridges, overpasses, and tunnels.

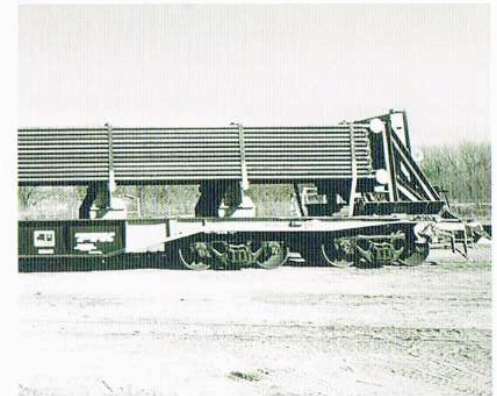

Flush deck heavy-duty flatcar



Enclosed railcars called *boxcars* range from 50 to 90 feet long and carry general freight in plain cars or products requiring special equipment or handling.

In 1857 a Chicago meat packer shipped the first refrigerated car, which was cooled by placing chunks of ice at each end of the car. Today's refrigerator cars have high-tech mechanical or chemical cooling machinery.

Railcars with valuable perishable cargo often run in *express lanes*, which are given priority over other rail traffic.



Refrigerated boxcars (nicknamed *reefers*) haul perishables such as fruit, beef, cheese, poultry, fruit juices, and frozen foods maintained at minus 10 degrees F.

Covered hoppers, the most common kind of freight car in North America, transport loads—such as grain and sugar—that also require protection from contamination and the weather. These cars empty through the bottom.



Open-top hoppers are used for freight like coal, mineral ores, sand, gravel, and crushed stone for track ballast.



Mill gondolas provide the maximum open carrying capacity for exposed loads. For protected loads such as steel coils, gondolas are equipped with removable covers. Side-dump gondolas can unload by tilting to either side; coal-carrying gondolas unload by turning upside down.



Tank cars carry liquids, mostly petroleum products such as fuel oil and petrochemicals, and liquids like vegetable oil, and are sometimes pressurized. Some tank cars have special linings to contain hazardous chemicals.

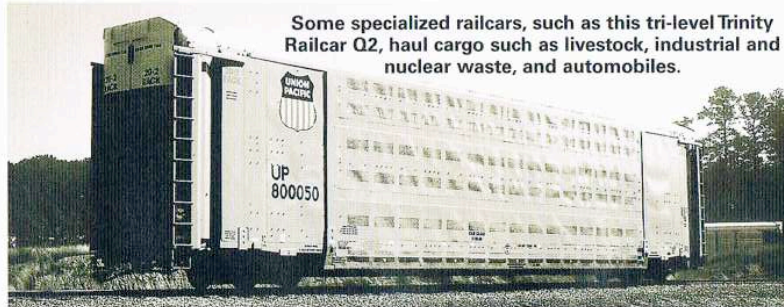

Some specialized railcars, such as this tri-level Trinity Railcar Q2, haul cargo such as livestock, industrial and nuclear waste, and automobiles.

Many modern freight cars have a *gross rail weight* (GRL) of 286,000 pounds, which includes the weight of the car when empty (light weight or LT WT) plus the maximum weight, in pounds, of freight the car can carry (load limit or LD LMT). Today's railroads test railcars with a GRL of 315,000 pounds.

Starting a Train

Two main factors determine a locomotive's ability to move a train: the relationship of its *horsepower* to *tractive force*, or the amount of power produced to the amount of force exerted. Two other factors also are important: the rails' angle of incline and the adhesion (grip of the wheels to the rails). Although a single locomotive exerting a weight of as much as 70,000 pounds per axle can pull many cars, two or more locomotives—distributed throughout the train and remotely controlled from the lead locomotive—may be required to pull very long and heavy trains.

Reporting Marks

Each freight car carries on its sides a variety of stenciled letters and numbers that reveal a great deal of information about the railcar. Letters (and logos) indicate the name of the railroad or leasing company moving the freight, such as "BNSF" for Burlington Northern and Santa Fe. Each car carries a unique number so it can be identified in rail yards and directed appropriately. Another number, often preceded with "BLT," shows the date each car was built. Other numbers give you the inside dimensions of the car, its weight without load, or *tare*, and fully loaded (gross weight). The maximum capacity (CAPY) in cubic feet also is stenciled on the car.

Radial Steering Trucks

A locomotive's "trucks" are the complete assemblies of driving wheels, axles, gearboxes, brakes, coil springs, and other parts—mounted in a frame. Radial steering trucks are hinged to flex and steer the wheels smoothly through curves. These trucks reduce wheel and track wear and provide better adhesion.

Most of today's railroad locomotives are "fired" by diesel fuel. A diesel-electric locomotive, the most common locomotive in service today, has a main diesel engine, which runs a large electric motor called a *traction alternator*. The generator produces electricity to power the electric *traction motors*, which are mounted—one per axle—on the power trucks.

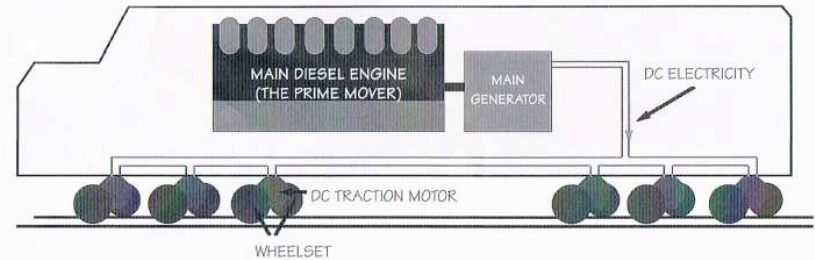

Diesel-electric locomotive with DC (direct current) traction motors

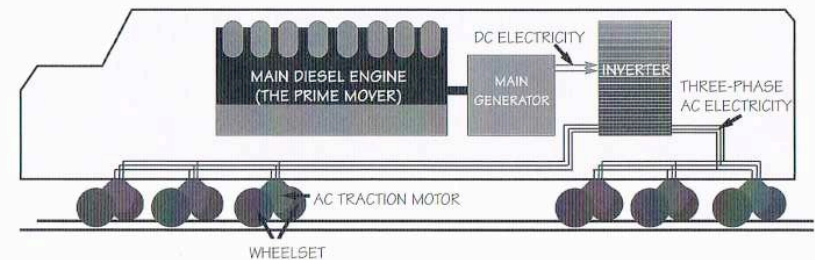

Diesel-electric locomotive with AC (alternating current) traction motors



Electric locomotives (without a diesel engine) collect current from overhead wires, or *catenary*, through metal arms called *pantographs* mounted on the roof. Others use a pick-up shoe to collect current from an electrified *third rail* placed next to the running rails. The locomotive's internal equipment converts high-voltage current to lower voltage current.

Locomotives, especially on passenger commuter trains, often push rather than pull their cars. The train has a locomotive on one end and a passenger car equipped with an engineer's cab and duplicate controls on the other end. It can be operated from either end, so it doesn't have to be turned around to make a return trip.

Stopping a Train

Electric multiple-unit (EMU) commuter trains are self-propelled; all cars (from eight to 12) can be controlled from one cab.

A train stops by using an air brake system, which allows the engineer to apply the brakes to all cars at once. An air compressor fills a main air reservoir, located in the locomotive, with compressed air. Then the air is piped through the brake pipe, which is connected from the locomotive and car to car by hoses. When the train is in motion, air passes through triple valves on the brake pipe to an auxiliary reservoir in each car. When the engineer applies the brakes—releasing air from the brake pipe—the valves move upward and let air from the auxiliary reservoirs flow into the brake cylinders. The cylinders then push against the pistons, forcing the brake shoes against the wheel rims.

The engineer releases the brake by increasing the air pressure in the brake pipe. That pushes the triple valves down, allowing the air in the brake cylinders to escape to the outside through the valves. Then the pistons release the brake shoes

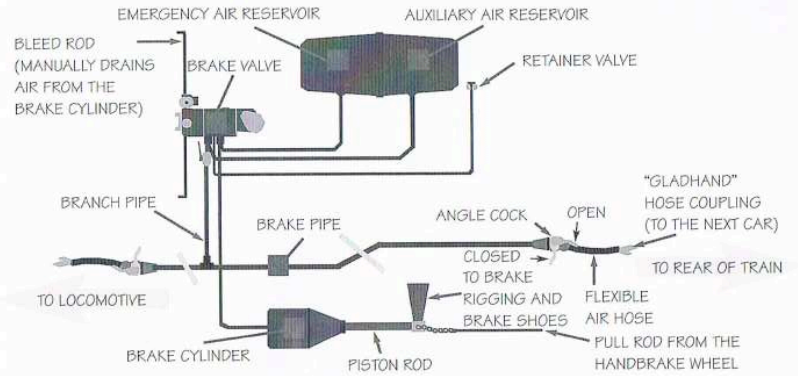

The railway air brake system is fail-safe because any air loss, either from manual release or an emergency such as a car becoming detached, automatically applies the brakes.

from the wheel rims. Compressed air from the brake pipe flows into the auxiliary reservoirs and the air brake system is ready for the next stop.

On locomotives with electric drive motors (traction motors) and most subway and other rapid transit cars, an electromagnetic system allows the motors to act as temporary generators during deceleration. The electrical current produced during braking is directed to large resistors, converted to heat, and then released into the atmosphere. This is known as *dynamic braking*.

At one time all freight trains had cabooses. But these special cars have been replaced with end-of-train devices (EOTDs) equipped with a bright flashing red warning light, also called flashing rear end devices (FREDs). These devices—always placed on the last car of a train—alert train crews by radio signal to problems detected in the air brake system. An engineer can also apply brakes from the rear of the train through radio contact with the EOTD.

In some electric locomotives, the electricity generated by traction motors for braking is fed back into the catenary or third rail. This is called *regenerative braking*.

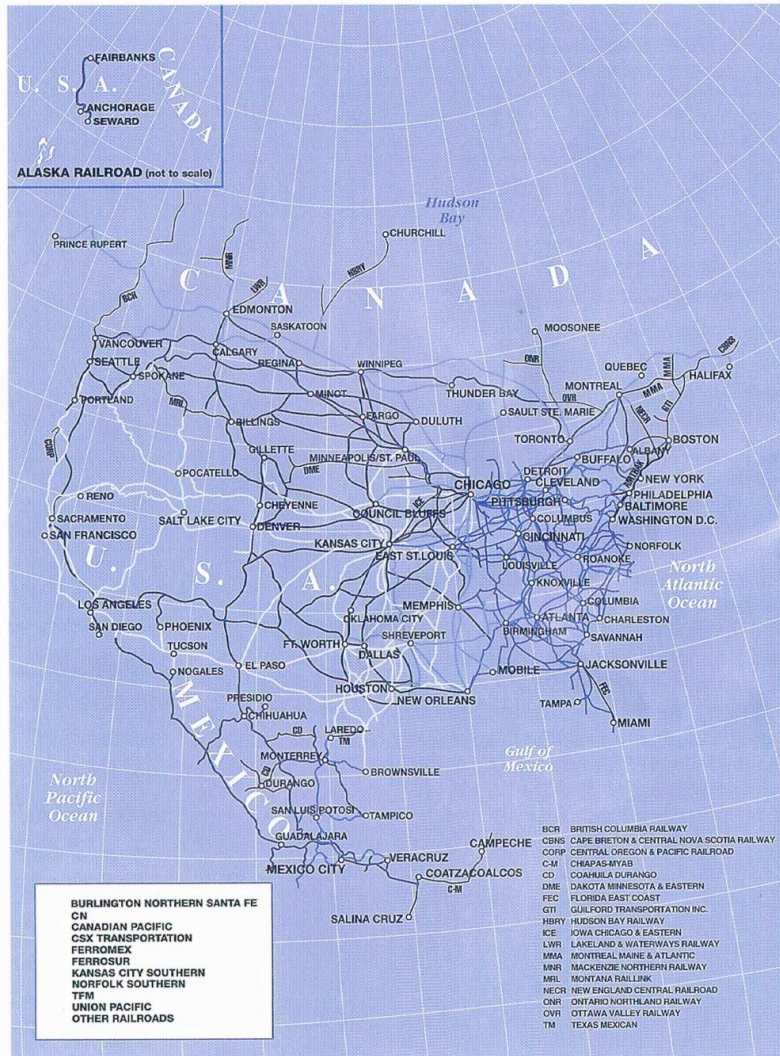

North American Network, Class I Railroad Routes (Not all routes are shown; the ones depicted are noted in the lower left-hand box.)



Dallas Area Rapid Transit (DART) operates a light rail system along 44 miles of rail and serves an average of more than 59,000 passengers weekly.

Railroad Classifications

Railroads in North America (including Canada and Mexico) run on approximately 200,000 miles of track and are classified by the route-miles on which they operate and on the amount of revenue (for hauling freight) they generate within one year. The nation's largest freight haulers, with revenues of more than \$250 million per year, are classified as *class I* railroads. Although there are fewer than 10 class I railroads, they own and maintain more than 76 percent of the track on this continent.

Next are the smaller *regional* carriers, followed by the *short lines*. These frequently handle class I railroad trains once they leave the main lines. Lastly, there are the *terminal* railroads, which typically switch and shunt cars around rail yards or in and out of factories and terminals.

Passenger railroads are classified by their *ridership* (numbers of passengers) or by the regions they serve. They operate by what is sometimes referred to as a fixed-guide path, traveling along an established route.

At first, rail passenger cars were little more than stagecoaches on steel rails. Today we still refer to passenger railcars—even highway buses—as “coaches.”

Amtrak also operates the Auto Train from Lorton, Virginia (south of Washington, D.C.), to Sanford, Florida. If you are going on vacation, you can bring your vehicle, too. For shorter distances, Amtrak provides comfortable coaches, often with food service cars.

Intercity passenger trains connect major cities, with stops in between at smaller towns. An example of such a system is Amtrak, which operates rail lines in 45 states.

Commuter trains travel within a metropolitan region. The Metropolitan Transportation Authority in New York serves more than 1.3 billion riders annually in an area encompassing New York City and surrounding counties.

Rapid transit (fast public transportation, also called *heavy rail* or *metro*) serves passengers within and around the edges of cities. They usually are configured as subways that run on underground or elevated guideways. In Georgia, the Metropolitan Atlanta Rapid Transit Authority (MARTA) operates 248 rail cars over 48 miles of track. San Francisco's Bay Area Rapid Transit (BART) system has a unique feature—an underwater tube that links communities surrounding the San Francisco Bay area. The largest system is New York City Transit, which carries more than 4 million riders per day over more than 700 miles of track and uses more than 6,000 cars.

Light rail transit systems—with their light rail vehicles (LRVs), the modern version of trolley cars—are generally powered by catenary and travel on smaller track. Buffalo, New York's Metrorail, which has 6.2 miles of track, is one such example. In Oregon, the Metropolitan Area Express (MAX) serves the greater Portland metropolitan area along more than 35 miles of track.

Monorail trains, also classified as rapid transit, are suspended from an overhead track or set on a single rail. They generally are used for short runs such as at airports or between other close transportation points, in amusement parks, or at other attractions.

America's Passenger Rail Service

In 1971, the U.S. Congress created the National Railroad Passenger Corporation—called *Amtrak*—to take over and operate the nation's intercity passenger rail service. This national service was established to relieve the nation's private railroads of all passenger service, which had become unprofitable because of competition from automobiles and airplanes. Amtrak operates some commuter lines under contract to local transportation authorities.

Today Amtrak carries 23 million passengers a year over more than 22,000 miles of track, almost all of it owned by the class I freight railroads. The exception is the Northeast Corridor (NEC), where Amtrak owns and maintains most of this high-speed electrified rail line between Boston, Massachusetts, and Washington, D.C. Long-term plans are under way to extend this rail corridor south to Richmond, Virginia, and add other high-speed lines in California, the upper Midwest, and Southeast.



For long-distance travel, you can ride Amtrak's bi-level Superliner, which is like a hotel on wheels. It offers sleeping accommodations with private showers, dining facilities, and observation decks.

Standard Time

Before this nation's "iron network" connected communities across North America, each town set its clocks by the sun. So time varied from place to place, with the time in towns to the west running minutes behind the time in towns to the east. As travel increased on the railroads, it became obvious that passengers could no longer rely on scheduled service based upon published timetables. To make the coordination of train arrival and departure times easier, the rail industry agreed to set all its clocks along a line to one operating time. It was called *railroad standard time*, later shortened to standard time.

The TGV is the world's fastest regularly scheduled train service, traveling nearly 200 mph. High-speed trains also operate in England, Spain, Italy, and Austria, and soon will operate in China and Taiwan.

High-Speed Trains

High-speed (normally 125 mph and over) passenger rail service is common throughout the world. The best known are the Japanese Shinkansen bullet train, the German InterCityExpress (ICE), and the French TGV (Train à Grande Vitesse, or "train of great speed"). These trains can reach speeds of 200 mph because they run on their own right-of-way. In the United States, however, Amtrak's high-speed Acela Express (combination of *acceleration* and *excellence*) shares its track with slower commuter and freight trains. It operates in the Northeast Corridor and attains speeds up to 150 mph from Boston to New York, and up to 135 mph from New York to Washington, D.C. Its high-speed train cars tilt, or lean in, toward the inside of curves, allowing the trains to negotiate the bends quickly and as smoothly as if the tracks were straight.



The Acela Express is called a *trainset* because the cars—electric locomotives at each end and six coaches in between—operate as one unit.

Railroad of the Future?

Today there is a kind of experimental railroad that doesn't actually touch its guideway once under power. It is called *maglev*, short for magnetic levitation. An electromagnetic field suspends the lightweight vehicles, which look like wingless airplanes, from three-eighths of an inch to as high as six inches off the rails. The guideway is called a *magway*. It can be constructed along the median center strip of a divided highway or alongside other roads much like monorail, separate from motor vehicle traffic. As with regular electric trains, there is no fuel carried on board a maglev train—and no motor. *Magports* provide the driving force for this "floating train" by means of what is called magnetic repulsion.

Maglevs are quiet, produce no pollution along the guideway, and can climb steeper grades and turn tighter corners than conventional trains. The only friction encountered once under way is wind resistance. Maglev trains require only one-tenth of the power needed to move a regular train. Many people think that once the high costs are resolved, maglev will replace conventional passenger railroading.

Under experimental conditions in Germany and Japan, maglev vehicles have traveled as fast as 340 miles per hour.

Signals

There is one signal that anyone, including members of the public, can use in an emergency to communicate with a railroad crew to stop the train: Wave any object—an arm, flag, lantern, T-shirt—violently across the tracks.

The safety of passenger and freight train operations requires constant communication among train crews, employees who maintain the track and equipment, and those who control train traffic. Over the years railroads have used many methods: hand signals, flag signals, flares, whistle signals, lighted signals called block signals and interlocking signals, and telegraph, telephone, telefax, radiophone, walkie-talkies, microwave systems, cell telephones, and satellites. All employees involved with train operations must learn the signal techniques defined in their railroad's operating rules book and carry the book while at work.

Since the early days of railroading, train crew members have used hand signals. At night they signaled with lighted lanterns. The old oil- or kerosene-powered lanterns have become collectibles. Today's train crews carry battery-powered railroad lanterns as part of their standard equipment. Railroad employees rarely use hand signals and now use walkie-talkies to communicate directly with each other.

The train's engineer uses horn signals to respond to the hand signals or radio commands from train crew members, track workers, and other trains, and to make other employees aware of the train's movement. Horn signals also are used to alert the public when a train is nearing a highway-rail grade crossing as well as approaching or departing from a train station. The chart shown here summarizes the commonly used horn signals heard around a railroad.

In the past, trains left stations—one after another—on a paced schedule. Each train was expected to travel a certain distance in a certain time period before the next train was allowed to leave. But spacing the trains by time did not take into account weather conditions or other physical issues such as mechanical breakdowns. The only way to prevent a rear-end collision was to send a crew member down the track to warn an approaching train of the stopped train ahead.

To improve train control, railroads divided the tracks into sections called *blocks*. A block operator stationed at the entrance to each block would allow one train into the section. No other train could enter that block until the first train had left. Block operators communicated by telegraph and telephone to inform other operators of each train's movement in and out of the blocks. This way of separating trains by space was better than separating them by time, but it still depended too much on human intervention.

At junctions and terminals (called interlockings) where trains may change tracks, interlocking signals give lighted commands to the trains. Originally a worker in a signal tower or a station building would set the routes and signal displays

Horn Signals

Engine Horn	Meaning
"O" is a short blast; "~" is a long blast.	
O	Apply brakes. Stop.
OO	Engineer's answer to any signal unless otherwise specified.
OOO	When standing, back up; when running, stop at next station.
OOOO	Engineer's request for signals.
OOOOOOOOOO, etc.	Person or livestock on track (series of short blasts).
~~~~~ , etc.	Approaching stations, junctions, or railroad crossings at grade (series of long blasts) without stopping.
~OO	A second section is following; call for other trains to signal.
~OOO	Flagman to go out to protect rear of train.
~~	Release brakes. Proceed.
~-O~	Train is approaching public crossing at grade.
~~~~	Flagman may return from west or south.*
~~~~	Flagman may return from east or north.*

*These horn signals may be followed by "O" or "OO" or "OOO" when several tracks are in use. The number of short blasts corresponds to the track number.



to permit the trains to enter the interlocking area. Complex sets of lighted signals with many aspects conveyed commands so that the train engineer would know what speed was permitted within the interlocking and what type of track change to expect.

With the invention of Centralized Traffic Control (CTC) in 1927, remote operators called dispatchers were able to control interlockings by working with lighted track diagram panels called CTC machines. Nowadays, dispatchers—hundreds or even thousands of miles away from the actual track site—control these interlockings with computer graphics displays.

### 2-block, 3-aspect signaling

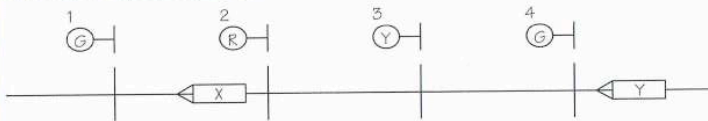

In this basic block layout, each signal is spaced a safe braking distance apart based on the maximum permissible speed for that section of railroad. The signals (1, 2, 3, and 4) can display three colors, called aspects, and are defined as follows: Green means "proceed at up to maximum permissible speed." Yellow means "proceed at reduced speed; be prepared to stop at next signal." Red means "stop."

In the 1870s, thanks to the invention of the closed-track circuit and track relay, railroad employees could detect the presence of a train on the rails and know whether it was occupying a block. Later, in 1911, the railroads developed a system of electromechanical devices and circuitry called Absolute Permissive Block (APB) signaling. In this system, trains operate with full signal protection based on automatic train detection by the track circuits.

With APB signaling, the trains themselves control the signals. As a train enters a block, which is an electrical circuit, it shorts out the circuit and activates a STOP signal, which warns other trains not to enter the block. As the train moves ahead, a signal at the entrance to the next block gives a lighted command (called a *signal aspect*) to the train indicating whether or not it may enter. If the signal displays a permissive (GO) signal allowing the train to enter, it also may show one of several permissive signals that convey the maximum speed permitted while the train passes through the block.

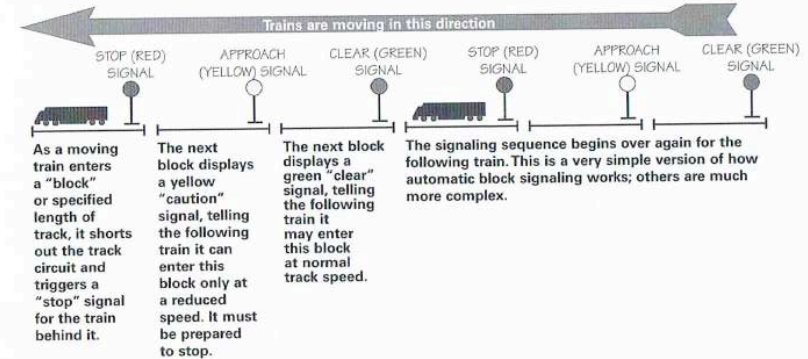

### How automatic block signaling works

## Semaphore and Signal Lights

Over the years, railroads developed various styles of lighted signals. Originally, semaphore signals extended like arms over the tracks. In the vertical position, the signal meant "proceed at maximum permissible speed"; in the diagonal position, "restricted speed"; and in the horizontal position, "stop."

Eventually, colored lights were combined with the semaphore signals for better visibility. The *searchlight* signal, which passes a light through a moveable colored lens and then through an optical magnifying lens, is bright enough for both daytime and nighttime operations. A *position light* signals with three fog-penetrating yellow lamps in the same positions (with the same meanings) as semaphore signals. *Color light* signals use one bulb with one color lens. Locomotive engineers and other railroad workers must memorize these signals to safely operate the trains.

Trains that operate faster than 79 mph must use *cab signals*. Electronic messages transmitted through the rails are picked up by a receiver in the locomotive and displayed inside the engine cab. The engineer gets information such as speed limits along specific sections of track, rail conditions, and wayside warnings—even when the train can't be seen.

In the near future, railroads may stop using track circuits or block signals. Today, rail companies are working with the signal supply companies to develop and test two-way radio and satellite-based location determination systems such as *Global Positioning System* (GPS) to create safer and more effective train control systems.

The traffic lights you see at major intersections in towns and cities are adaptations of the railroad lights to signal stop (red), proceed with caution (yellow), and go (green).



## Safety First

About every 90 minutes somewhere in this nation a train and motor vehicle collide. Or a pedestrian is hit by a moving train at a crossing, on a bridge, in a tunnel or at its entrance, or along the tracks.

Railroads take extreme precautions to operate trains safely. However, the best signaling systems and state-of-the-art technology cannot prevent most of the accidents that occur on the tracks. Impatient, inattentive, or daring drivers and trespasser-pedestrians cause most railroad-related deaths.



**Operation Lifesaver Inc.** is a public awareness program that promotes rail safety by educating drivers about the dangers of highway-rail crossings. OLI is dedicated to reducing crashes, injuries, and deaths at intersections and on railroad property.

A train cannot suddenly steer its way out of trouble ahead. The National Safety Council calculates that a loaded train of 100 or more cars needs better than a mile to stop—that is the length of 18 football fields. So it is your duty to stay out of the train's way.

Look for signs warning of rails ahead.

- Pavement marked with the letters **RXR** and, often, a stop line in advance of the grade crossing.
- Circular yellow warning signs that say **RR Xing**. Apply brakes while waiting at the crossing.
- Crossbuck, a white reflectorized X-shaped sign that says **Railroad Crossing**. It has the same meaning as a yield sign. A smaller sign below the crossbuck indicates multiple sets of tracks.
- Diamond-shaped yellow sign with track designation in the center means to stop 15 feet back from the rails.

These signs are known as *passive warning devices* because they are not mechanically operated like gates and flashing lights.

If you think that highway-rail grade crossing signals are not working, immediately call 9-1-1 and report the problem and location. Then contact the railroad at the toll-free number posted on a signal building or cabinet at the crossing.





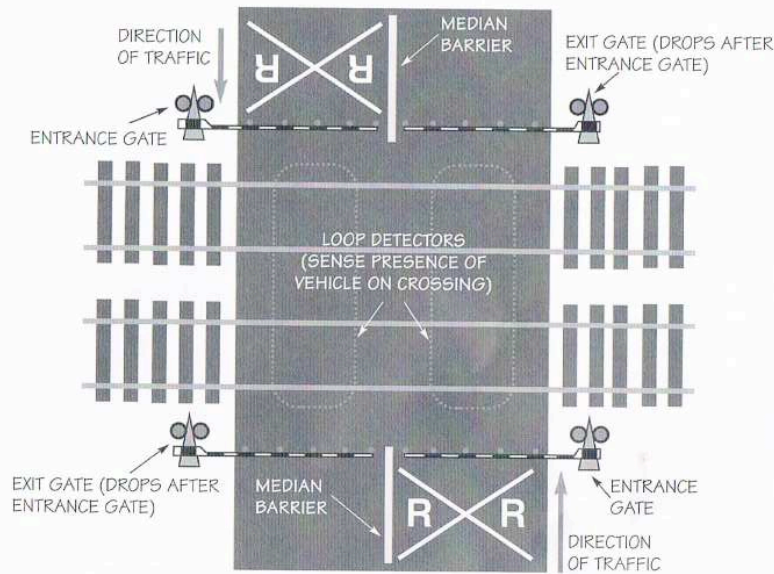

Highway-rail grade crossing warning system

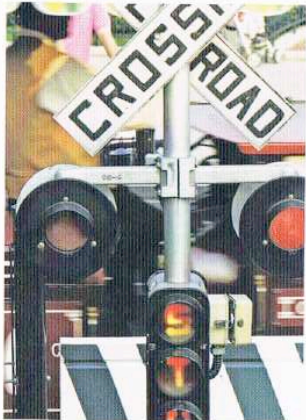

Railroad crossbuck

Busier railroad crossings require *active warning devices* such as a crossbuck with alternating flashing red lights, a bell, or lights and bells in combination with gates that drop.

Drivers can avoid accidents if they respect the power and speed of trains. As trains approach head-on, they appear to be moving slower than they really are. Surprisingly, many train-car collisions are the result of an inattentive driver plowing right into the side of a train already across a highway. Know this: A collision with a train is 30 times more likely to result in death than a crash between two cars.

## Always Expect a Train

You can't rely on train schedules to determine when a train might cross a highway-rail intersection. Proceed through a crossing only if you are sure you can safely cross the tracks. If your vehicle stalls or breaks down on a crossing, get everyone out immediately, move away from the tracks, then call the police to head off the next train.

Every year, many people are killed because they walk or play on or near the tracks. The railroad right-of-way is private property. Of course you may cross the tracks at a public grade crossing, but then you must move on; otherwise, you are trespassing. The law is for your protection.



Drivers of cars, trucks, buses, motorcycles, and bicycles should:

**Never** drive around any gates that are down, even if you

think the train has stopped up the track or the signal is defective.

**Never** drive around flashing crossing gates.

**Never** stop a vehicle on the tracks.

**Never** assume that a passing train is the only train on a multiple-track crossing.

**Never** pass another vehicle or even shift gears while crossing the tracks.

**Never** cross the tracks anywhere but at the public grade crossing.

**Never** operate an off-highway recreational vehicle or ride a bike along any rail right-of-way.

**Never** race a train along the right-of-way.

**Never** try to beat a train to a crossing. If you tie, you lose.

*Yikes!* Imagine a 3,000-pound vehicle crushing a 12-ounce soda can on the pavement. That is what happens to a car hit broadside by a train.



Don't forget: The track and active warning signals use electricity.

Today's trains are much quieter and move faster. *Pay attention.* As one train clears a crossing, another may soon follow or come from the other direction on an adjoining track. So, always proceed with caution.

Onboard a train you should observe all posted safety rules and obey the conductor, whose word is "the law" on that train. Don't try to hop off or on a moving train. Don't loiter in vestibules between cars or run through the train. Finally, do not tamper with such emergency devices as emergency stop cords, fire axes, fire extinguishers, first-aid kits, and flares.



Be considerate of other passengers by not leaving your baggage in the aisle. Offer to do a Good Turn by helping fellow travelers with their luggage if they appear to be having difficulty, or by holding doors open.

Whether aboard a train or just crossing the tracks on the way to a friend's house, think "safety first" and you will always have a good trip.



### Safety Tips for You

- Avoid walking along tracks, especially while wearing earphones.
- Avoid fishing or diving from a railroad bridge or trestle.
- Take an alternate route instead of walking through tunnels, which allow very little clearance.
- Resist the temptation to place items on tracks— even coins to be flattened.
- Leave switches alone.
- Stay away from rolling stock such as sidelined cars, track maintenance equipment, piles of ties, ballast, or stacked rail.





## Railfanning

Many people believe there is no experience more exhilarating than standing trackside and clicking a camera as a restored steam locomotive rushes by, or flying down the rails on a high-speed train. Railfans love the history of railroading, the thrill of traveling “on the iron road,” or the fun of reading the marks on freight trains. So visit a railroad museum, learn about rail preservation, attend a prototype-train event, or take a train trip and become a railfan yourself.

### Planning a Rail Trip

The first question you need to ask when planning a rail trip is *Can I get to my departure point from here?* If passenger trains don’t stop in your town, you will have to make arrangements to get to a station. Once you know *where* your starting point is, you can plan a destination point.

Consider these questions before you finalize your trip itinerary:

- What is the purpose of the trip?  
To ride an historic train?  
Visit a particular city?  
Photograph scenery?
- How much time do you have?  
A day? A week?
- How much do you want to spend?  
Food on board? Sleeper car?
- What kinds of trains depart from your starting point?  
Commuter? Intercity?

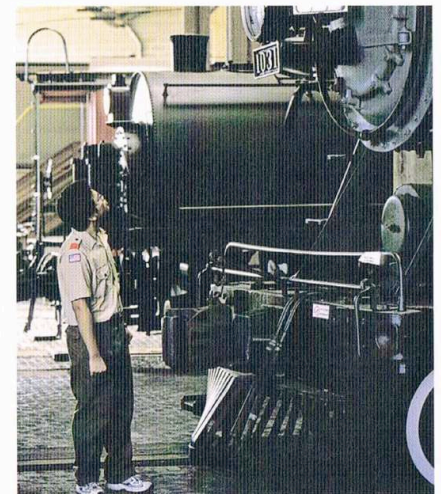



Westbound and southbound trains carry odd numbers; eastbound and northbound trains carry even numbers.

Now you can shape your trip. You may buy vacation planners and local sightseeing guides, but you *must* get a railroad timetable for the train you wish to take. You can pick one up at the train station or print one from the Internet (with your parent's permission). Or you can request one by mail. Study the timetable carefully. It is full of information that you must understand if you want to have a good trip.

From the timetable shown here you can see that Amtrak's Crescent, Train No. 19, makes a daily departure (Dp) from New York, New York (designated "Mile 0") at 2:50 P.M. Refer to the key for "On Board Service" and you will discover that reservations are required for coaches and sleeping cars, and that food is available in the dining car and the lounge. You will find more information under the "Symbol" column; the timetable includes a key for symbols and reference marks.

A heavy arrow indicates that the train does not stop until it reaches a station marked "(Ar)" for arrival. However, you may see symbols to the left of the arrival times, which indicate that passengers are allowed, under certain circumstances, to board or disembark at specific stations. So if you boarded the train in Washington, D.C., your first opportunity to get off the train is in Culpeper, Virginia.

Now that you know how to read a timetable and have decided where to go, are you ready to buy a ticket? You can make a reservation and purchase your ticket in person at the train station, by telephone, or on the Internet (an adult must do this for you).

Once on board, you will give your ticket to a conductor, who will punch out your destination station on a seat check and give that to you. Your name is not on the seat check, so take it with you when you move about the train.

Notice that afternoon and evening arrival and departure times are listed in **bold** numbers, and time zone changes also are indicated. If you rode from New York to New Orleans, how many nights would you spend aboard the train?

AMTRAK									
Crescent									
New York–Washington–Charlotte–Atlanta–Birmingham–New Orleans									
EFFECTIVE OCTOBER 27, 2003									
19	◀ Train Number ▶								20
Daily	◀ Days of Operation ▶								Daily
Ⓜ Ⓟ	◀ On Board Service ▶								Ⓜ Ⓟ
Read Down	Mile	▼		Symbol	▲	Read Up			
<b>2 50P</b>	0	Dp	New York, NY–Penn Sta. (ET)	Ⓜ Ⓟ ● ● ●	Ar	<b>2 01P</b>			
<b>R 3 07P</b>	10		Newark, NJ–Penn Sta.	Ⓜ Ⓟ ● ●		<b>D 1 38P</b>			
<b>R 3 48P</b>	58		Trenton, NJ	Ⓜ Ⓟ ● ●		<b>D 1 00P</b>			
<b>R 4 35P</b>	91		Philadelphia, PA–30th St. Sta.	Ⓜ Ⓟ ● ● ●		<b>D12 18P</b>			
<b>R 4 59P</b>	116		Wilmington, DE	Ⓜ Ⓟ ● ● ●		<b>D11 55A</b>			
<b>R 5 58P</b>	185		Baltimore, MD–Penn Sta.	Ⓜ Ⓟ ● ● ●		<b>D11 03A</b>			
<b>R 7 10P</b>	225	Ar	Washington, DC	Ⓜ Ⓟ ● ● ●	Dp	<b>D 9 50A</b>			
			Ⓜ Ⓟ Washington, Dulles Airport—see other side		Ar	<b>D 9 22A</b>			
<b>7 29P</b>	233		Alexandria, VA	Ⓜ Ⓟ ● ●		<b>D 9 22A</b>			
<b>8 02P</b>	258		Manassas, VA	○		<b>8 31A</b>			
<b>8 35P</b>	293		Culpeper, VA	○		<b>7 57A</b>			
<b>9 27P</b>	337	Ar	Charlottesville, VA	Ⓜ Ⓟ ● ●	Dp	<b>7 05A</b>			
<b>9 32P</b>			Ⓜ Ⓟ Washington, Dulles Airport—see other side		Ar	<b>6 59A</b>			
<b>10 56P</b>	398		Lynchburg, VA	Ⓜ Ⓟ ● ●		<b>5 51A</b>			
<b>11 52P</b>	461		Danville, VA	Ⓜ Ⓟ ● ●		<b>4 41A</b>			
<b>12 38A</b>	512	Ar	Greensboro, NC	Ⓜ Ⓟ ● ●	Dp	<b>3 39A</b>			
<b>1 03A</b>			(Winston-Salem)	Ⓜ Ⓟ ● ●	Ar	<b>3 34A</b>			
<b>1 17A</b>	524		High Point, NC	Ⓜ Ⓟ ● ●		<b>3 16A</b>			
<b>1 57A</b>	559		Salisbury, NC	Ⓜ Ⓟ ● ●		<b>2 35A</b>			
<b>3 00A</b>	601	Ar	Charlotte, NC	Ⓜ Ⓟ ● ● ●	Dp	<b>1 49A</b>			
<b>3 30A</b>				Ⓜ Ⓟ ● ● ●	Ar	<b>1 23A</b>			
<b>3 57A</b>	623		Gastonia, NC	○		<b>12 43A</b>			
<b>4 59A</b>	678		Spartanburg, SC	○		<b>11 43P</b>			
<b>5 39A</b>	709	Ar	Greenville, SC	Ⓜ Ⓟ ● ●	Dp	<b>11 00P</b>			
<b>5 46A</b>				Ⓜ Ⓟ ● ●	Ar	<b>10 55P</b>			
<b>6 24A</b>	739		Clemson, SC	○		<b>10 18P</b>			
<b>7 00A</b>	773		Toccoa, GA	○		<b>9 42P</b>			
<b>7 43A</b>	810		Gainesville, GA	○		<b>9 01P</b>			
<b>8 58A</b>	859	Ar	Atlanta, GA (ET)	Ⓜ Ⓟ ● ● ●	Dp	<b>8 06P</b>			
<b>9 18A</b>			Ⓜ Ⓟ Montgomery, Mobile, Chattanooga, Nashville, Hartsfield Int'l Airport—see other side		Ar	<b>7 36P</b>			
<b>10 40A</b>	959		Anniston, AL (CT)	Ⓜ Ⓟ ● ●		<b>4 00P</b>			
<b>12 24P</b>	1023	Ar	Birmingham, AL	Ⓜ Ⓟ ● ● ●	Dp	<b>2 27P</b>			
<b>12 44P</b>			(Samford University)	Ⓜ Ⓟ ● ● ●	Ar	<b>2 19P</b>			
<b>1 52P</b>	1078		Tuscaloosa, AL	Ⓜ Ⓟ ● ● ●		<b>12 50P</b>			
<b>3 33P</b>	1175		Meridian, MS	Ⓜ Ⓟ ● ● ●		<b>11 16A</b>			
<b>4 30P</b>	1231		Laurel, MS	Ⓜ Ⓟ ● ● ●		<b>10 14A</b>			
<b>5 00P</b>	1260		Hattiesburg, MS	Ⓜ Ⓟ ● ● ●		<b>9 40A</b>			
<b>6 01P</b>	1324		Picayune, MS	○		<b>8 36A</b>			
<b>6 23P</b>	1342		Slidell, LA	○		<b>8 15A</b>			
<b>7 55P</b>	1377	Ar	New Orleans, LA (CT)	Ⓜ Ⓟ ● ● ●	Dp	<b>7 20A</b>			
			Ⓜ Ⓟ Baton Rouge—see other side						

**Services on the Crescent**

- Ⓜ Coaches: Reservations required.
- Ⓟ Sleeping Cars: Reservations required. First Class Viewliner® standard, deluxe and accessible bedrooms. First Class Service includes complimentary meals and morning wake-up service with a newspaper, coffee, tea and orange juice. ClubAcela is available in New York, Philadelphia and Washington, D.C. and private waiting area available in New Orleans for First Class Service passengers.
- ★ Dining Car: Complete meals.
- ☐ Lounge: Sandwiches, snacks and beverages.
- Trails and Rails Program:** In a cooperative effort with the National Park Service, an interpretive guide provides a narrative along the route.
- Smoking:** Cigarette smoking is permitted in a designated portion of the lounge area. At certain times of the day, as announced by the train crew, the lounge area will be entirely non-smoking. No smoking in sleepers, coaches or dining cars.



Remember that your behavior reflects on yourself—and all Scouts—so be a courteous traveler.



Remember to bring a map along so you can figure out where you are and recognize prominent geographical landmarks along the way. Amtrak partners with the National Park Service for a "Trails and Rails" program. During certain months, interpretative guides talk to the passengers about the areas through which the train passes.

## Railroad Expressions

If you are a true railfan, you will want to know the history of some of the railroad expressions used today.

**Full steam ahead**—Go forward at the greatest speed possible, or with as much energy and enthusiasm as possible. The expression comes from an instruction to the engineer to power up a steam locomotive.

**Hit the ground running**—Get off to a fast start. Railroad workers often jump off a train while it is still moving, so their feet must be in motion when they hit the ground.

**Jerkwater town or one-jerk town**—Insignificant or out-of-the way. Often along main lines but where train crews gave only one jerk on the tower spout to top off locomotive tender water tanks.

**On the right track**—Going the right way, following the right assumptions. This phrase comes from a train ready to go on its assigned track.

**One-track mind**—A mind that thinks about only one subject, like a train that follows one track and never switches to other tracks.

**Railroaded**—Pushed through hastily (as a law) so there is no time to consider objections. This dates back to a time when farmers and other rail shippers felt they were being taken advantage of by high railroad freight rates.

**Sidetracked**—Distracted from the main subject or forced off one's intended course. In railroading, it means a car moved off the main track to an auxiliary track.



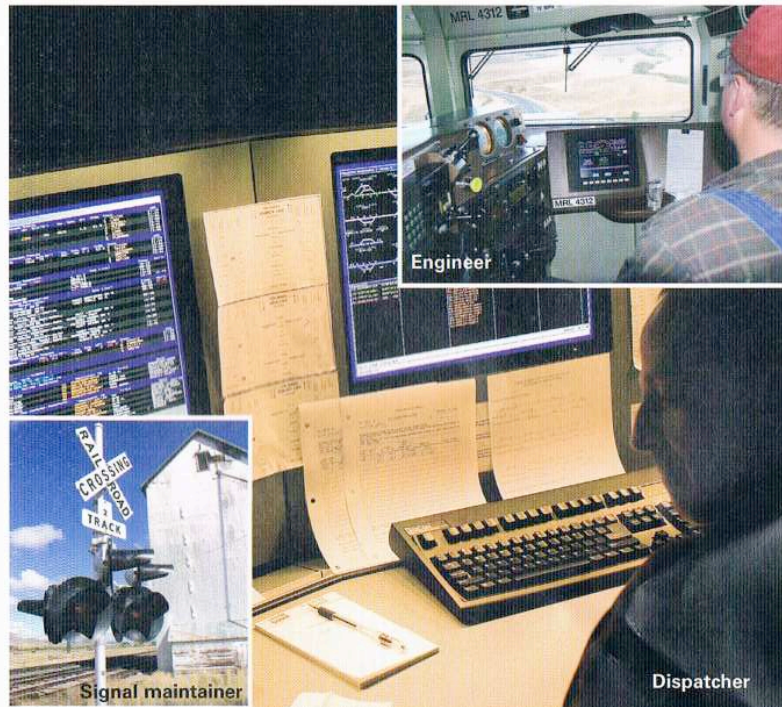

Some of the departments within a typical railroad include:

- Executive and management
- Operations, which manages the trains, other rolling stock, and roadbed
- Transportation, which schedules trains
- Mechanical, for repairs and inspections
- Engineering, for planning, layout of tracks and other facilities, and signaling
- Sales, to market and sell the railroad's services
- Legal, to handle all such matters
- Finance, to track revenue and expenses and the purchase of needed supplies and equipment
- Human resources, to handle employment and benefits
- Public relations

## Careers in Railroading

If you want to be a railroader, you can follow many career tracks. It is much like entering a classification yard, with certain rails leading to railroad operations, others to management, purchasing, engineering specialties, even public relations and corporate communications. Most class I railroads have more than 100 classifications for positions including mechanic, signal and communications worker, marketing and sales representative, lawyer, accountant, surveyor, track foreman, and station agent. All are important for the smooth operation of the railroad.

To work for the railroad, you must be in good physical shape and have a high school diploma (at the minimum, although a college diploma is preferred). You will have an edge if you have work experience in railroading or other related fields of transportation, mechanical talent, and the ability to think straight in an emergency situation.

### Railroad Organization

Railroad companies have five basic components.

1. **Fixed plant**—track, track bed, supporting structures like bridges and trestles
2. **Rights-of-way**—strips of land for track, stations, and other buildings
3. **Rolling stock**—locomotives, freight cars and passenger coaches, sleeper and dining cars, work trains, and track inspection equipment
4. **Financial structure**—capital funds for the purchases of large items as well as operating funds for day-to-day expenses
5. **Human resources**—employees in the ranks of labor and management who make it all work

All these different components give any individual who is interested in the railroad industry a variety of career opportunities from which to choose.

---

Most railroad companies will send you materials and applications for employment. Better yet, visit a railroad office.

---





## Model Railroading

Model railroading is an educational hobby whose popularity is growing. Model railroad clubs exist worldwide and the number of individuals operating their own model railroads is increasing. Model railroads often have amazingly realistic scenery and frequently these modeled scenes represent portions of actual railroads. Many are now operated in the same way that real-life railroads are run.

Your local model railroad clubs and hobby shops can help you plan your layout. As you proceed, you may find that you are more interested in operations, in building cars or structures, in building scenery—or all of these. Attend public train shows in your area. Often, you will be able to buy secondhand items and sometimes complete layouts to save money. Model railroading has so many options that it is easy to learn about those areas that interest you most.

As your interest in this hobby grows, consider joining the National Model Railroad Association. Currently, there are more than 25,000 members worldwide. Your BSA local council can put you in touch with qualified NMRA members who are willing to serve as counselors for the Railroading merit badge.

### Scales and Gauges

*Scale*, in model railroading, refers to the proportion of a model as it relates to the size of the real object. For example, a 1:48 proportion means the model is  $\frac{1}{48}$ th the size of an actual train. Scale may also be expressed as a length measurement on the model (in fractional inches or millimeters) that represents one foot of length on a life-size (or prototype) train. While model

You can begin as a model railroader with a small layout. Expand it as your time and money permit. Be patient and do your best on each model so that it will give you a lifetime of service.



**Gauge** is the distance measured between rails. The terms *scale* and *gauge* are often confused.

Toy or "tinplate" trains are not true 1/4-inch scale because they are shortened to run on sharp curves; a tinplate passenger car may be only 6 inches long. Tinplate trains also run on three-rail track.

trains come in many scales and gauges, the most common sizes are referred to as No. 1 (G), O, S, HO, N, and Z.

- The *G* scale, or No. 1, is the largest scale and is most often used in garden or outdoor model railroads.
- The *O* scale dates back to the 1920s when mechanical or windup toy trains were common. Each 1/4-inch on an *O* scale model represents one foot on a full-size train, so the model for an 80-foot passenger car will be about 20 inches long.
- The *S* scale is about halfway between the *O* and *HO* scales.
- The *HO* scale is currently the choice of the majority of modelers. This scale takes about half as much space as *O* scale.
- *N* scale equipment is made to accurate scale, yet its small size takes only about half the space required for the *HO* scale. Reducing the space requirement allows modelers to use broader, more realistic-looking curves.
- The *Z* scale is the newest and smallest scale and was made possible by the development of precision subminiature motors.

North America's railroads operate on standard gauge track with rails spaced 4', 8 1/2" apart. Some tourist railroads in places such as scenic areas or at amusement parks operate on narrow gauge track with rails spaced only 3 feet apart. Model railroaders add a letter "n" and the track gauge to the scale name (On3, Sn3, or HOn3) when they refer to narrow gauge models.

### Scale and Gauge Chart

Name	Scale (In inches)	Relationship (To actual size)	Gauge (In inches)
G (No. 1)	.375	1/32	1.766
O	.250	1/48	1.250
S	.188	1/64	.875
HO	.138	1/87	.649
N	.075	1/160	.353
Z	.055	1/220	.250

### Layout Design

Planning a layout is a lot of fun, but you need to think about how much space you have before you choose your scale. Modelers build layouts in basements, attics, and garages. If you don't have much space, consider building a layout design on a low folding table with casters so it can be stored under a bed. Although a smaller scale allows you to build more railroad, it might be wise to select the scale you like the most.

Use a pencil to sketch your layout on graph paper, roughly to scale. As you draw your layout, consider several points: What kind of railroad do you like? What sorts of things will the cars haul? How much money can you spend?

If possible, try to design a layout that you can expand on later. The drawings shown here depict some common track planning ideas you may want to try.

### Layouts



Folded dog bone (More folds are possible.)



Oval with return cutoff; favoring clockwise operation

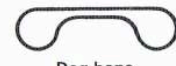

Dog bone



Return loops



Oval with two return cutoffs; favoring either direction



Loop to loop



Figure eight



Two-lap oval

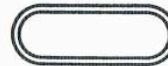

Two-track (or double-track) oval



Out and back with stub terminal

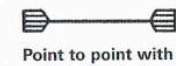

Point to point with stub terminals



Water wings

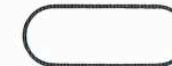

Oval



Point to loop



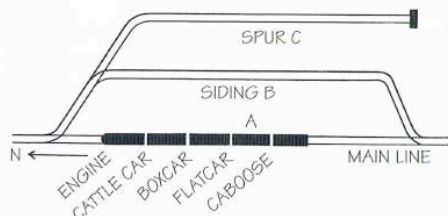

### Local switching

Local freight trains deliver cars to customers along their route. Suppose your train is traveling north on the main line at A. How can you deliver the cattle car on siding B and the flatcar on spur C? Now, suppose your train were traveling south. This would make it necessary to use siding B as a runaround track to get the engine to the other end of the flatcar. You will find at least one runaround track in most industrial areas.

Much of the fun in operating model trains comes from solving switching problems as the freight cars are delivered or picked up at points around the layout.

### Layout Construction

To ensure reliable operation, build your layout on a solid structure or table called *benchwork*. With your layout off the floor, you will keep the tracks and motors cleaner and avoid accidental damage. You also will find working on benchwork is easier than working on the floor.

Many layouts begin on 1/2"-thick plywood fastened to a 1"-by-4" framework. Using plywood thinner than 1/2" is not wise as it tends to sag between the supports, creating problems with your trackwork.

Ready-to-use track comes in standard straight, curved, and flexible sections with a variety of switches, crossings, and other components. Sectional track offers a lot of advantages for the first layout. If you change your mind, you can easily change your trackwork before fastening it to the plywood with scale spikes. You could use white glue for permanent fastening, but it is difficult to change track later. To make your trackwork more realistic, add finely graded gravel (scale ballast).

When you are ready to test the layout, watch how a train passes over every inch of the track. Fix any bumps or rough spots until the train runs smoothly. Now you are ready to add scenery.

### Scenery

Building scenery provides a setting for your trains. For a good starting point, assemble a few of the simple plastic building kits and set them in appropriate places on the benchwork. Use a pencil to sketch in roads, rivers, and other landscape features.

**Add a bi-level track** to lengthen the run and allow for more bridges and mountainous scenery. However, you will have to test your locomotive to see how many cars it can pull up the grade, or ramp, between the levels. As a general rule, a grade should not exceed 3 percent (the track rises 3 inches in height per 100 inches of length).

**Use a concealed-from-view track** to hide the train in a tunnel beneath a mountain or behind a backdrop. This lets you stop the train for a few moments to give the effect of a longer trip and a larger layout.

**Install a crossover**, made up of two facing track switches, to allow a train to leave one track and move onto a parallel line. The term "crossover" is sometimes confused with a *crossing*, where one track crosses another at an angle.

**Incorporate a wye** (pronounced "Y"), an interesting track arrangement made up of three turnouts (see the wye diagram). It is used to turn a train or locomotive. Throw switch A and proceed through one leg of the wye until the train is clear (or past) switch B. Throw switch B behind the train and then reverse direction to back through the adjoining leg of the wye to clear switch C. Throw switch C in front of the locomotive so you can return to the starting point (switch A) heading in the opposite direction.

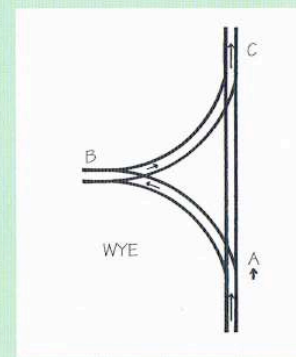

**Add a group of switch tracks** to make a classification yard where freight cars are sorted and connected to form trains. Arriving trains often have cars for several destinations mixed together. The yard crew sorts these cars into groups headed for one destination and then puts the groups in order for delivery.



You can create a rolling landscape by taping crumpled newspapers, paper towels, or bags to the plywood. Dip strips of paper toweling in soupy plaster and drape them over the newspapers in several layers. After the plaster sets, paint your landscape and add details.

You can buy model trees, or you can make your own from dried weeds, twigs, and fibers from old furnace or air conditioner filters. For extra texture, use commercial products such as ground-up foam rubber or dyed lichen.

Notice details in your neighborhood like signs, sheds, people, telephone poles, and animals. Think about how adding similar items to your scenery will make your layout come alive. While you are looking around, pay attention to how nature has weathered buildings, cars, fences, and equipment. If you want your models to look more realistic, "weather" them yourself. Tone down bright plastic buildings by spraying them with a light coat of clear dull finish, or apply a wash of thinly diluted India ink.

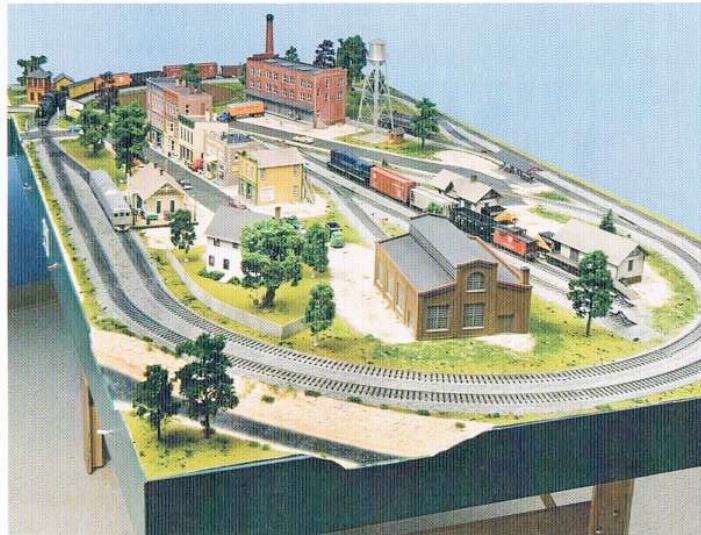

A good-looking layout doesn't have to be big to be fun to build and operate. This HO layout is built on a 4'-by-8' sheet of plywood.

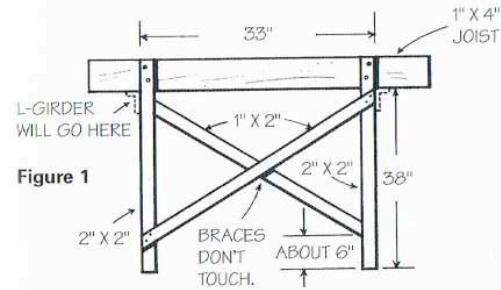

Figure 1

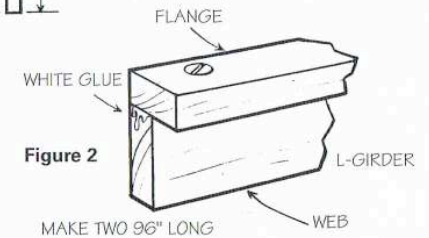

Figure 2

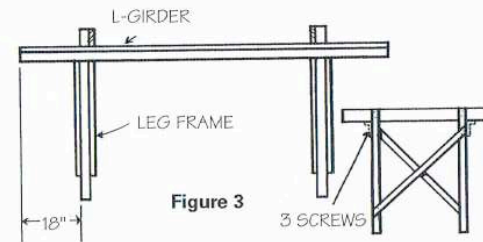

Figure 3

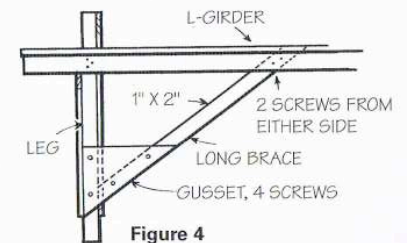

Figure 4

Benchwork plan



No screws should ever be driven down through the top. See figure 7.

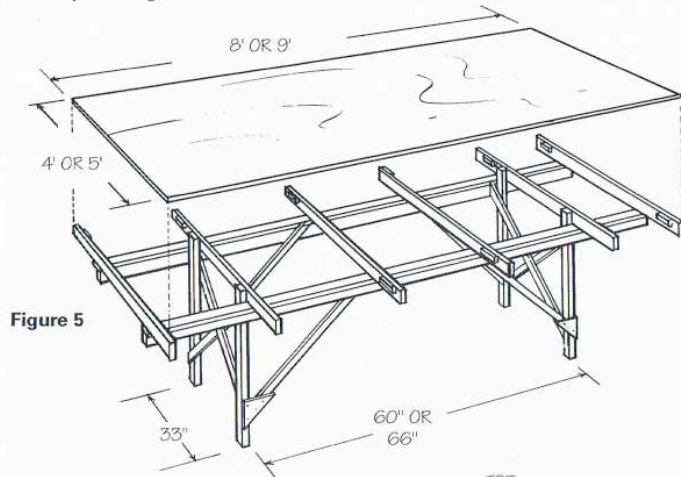

Figure 5

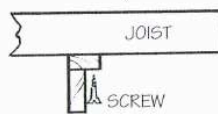

Figure 6

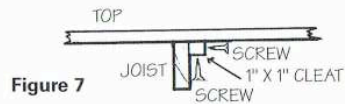

Figure 7



Sometimes it's fun to build models of historic trains that ran in the western mountains.



Here is a layout built to look like it's in the north woods, with trees made out of weeds.

### Rolling Stock

You can buy locomotives and rolling stock for your railroad "ready-to-run." Or you can buy kits, which come in various levels of difficulty and detail, from easy-to-assemble with simple details to difficult with elaborate features. Some people like *kit-bashing*, or combining parts from two or more kits (along with items found around the house) to build an item that is hard to find, unavailable, or original. Kit-bashing allows you to use your imagination *and* take advantage of premade parts.

You can build rolling stock from plans, parts, and materials—a practice called *scratchbuilding*. This requires following well-detailed plans and studying prototype photos to make the needed parts. Many model railroad magazines feature such plans and make parts available for cars and locomotives.



Because tinplate trains operate on AC current, they use a transformer that has variable speed control.



Some modelers like to build urban structures to create a city scene.

### Power and Control

For many years, two-rail scale layouts have been run by DC (direct current) power packs plugged into a wall outlet. Power packs include a transformer to reduce the 110-volt AC (alternating current) house voltage to about 18 volts before a rectifier in the circuit converts it to 12 volts DC. A rheostat adds variable resistance to the circuit to control the voltage (speed) while the DC polarity determines the train's direction. Many accessories operate on AC, so most power packs have extra wiring terminals labeled for this purpose.

Digital Command Control (DCC) is a new system for controlling two-rail layouts with simplified wiring. Each locomotive contains a decoder that can be linked to a specific throttle control or cab through the system's minicomputer. Throttle settings and other commands from the cab are broadcast as high-speed digital signals that travel through the entire layout. The locomotive's decoder responds only to signals from its assigned cab to operate the locomotive. Thus, DCC allows many locomotives to operate under individual control at the same time on a layout.

### Care of Equipment

You may need to clean your equipment occasionally. Use a clean, dry paintbrush to remove dust and any hair or lint that is caught in the moving parts. Clean the track with a dry abrasive block, which works better than applying cleaning fluids to a cloth pad.

The instruction sheet that accompanies most model locomotives explains how and where to lubricate the train cars. Be sure to get plastic-compatible lubricants and use them sparingly as too much oil is worse than too little. Rolling stock axles seldom need lubrication unless they are actually squeaking. Many good lubricants are available, so seek recommendations from a friend who has a model railroad or from someone at your local hobby shop.

Cars that frequently derail may need minor adjustments. You can buy a gauge to check wheel spacing and other standard dimensions from the National Model Railroad Association or a hobby shop. You may need to add weight to certain cars to improve performance. Consult printed guides (such as those published by NMRA) for correct car weight based on car length and scale.

### The Timesaver

The timesaver is a switching game that tests your problem-solving skills to see who can deliver all of the freight cars to their proper destinations in the shortest time. It is played on the standard HO layout shown in the drawing. Here is the list of the sectional track and other components it takes to build a timesaver using Atlas parts, which are widely available at hobby shops and online (only with your parent's assistance).

- 4 Atlas left-hand manual Snap-Switches®
- 3 Atlas 9" straights
- 1 Atlas 9" terminal section
- 6 Atlas 3" straights
- 1 Atlas short section assortment
- 11 Kadee No. 321 uncoupling magnets
- 1 power pack
- 5 40-foot freight cars: boxcar, gondola, hopper, refrigerated boxcar, and tank
- 2 Atlas right-hand manual Snap-Switches®
- 1 Atlas 9" rerailer

#### Timesaver hint:

Think ahead and carefully plan your switching moves to avoid extra moves that take more time.



- 2 Atlas 6" straights
- 2 Atlas 1 1/2" straights
- 5 Atlas bumpers
- 1 3/4" x 12" x 68" plywood board
- 1 diesel switcher (40-foot or smaller)

The game begins with the cars and locomotive positioned as shown in the diagram labeled "starting car positions." Set the throttle to a slow speed and then use the power pack's reversing switch to change direction as you switch the cars. The game ends when all of the cars have been delivered to the positions shown in the diagram labeled "finished car positions." The elapsed time is your score and the best time wins.

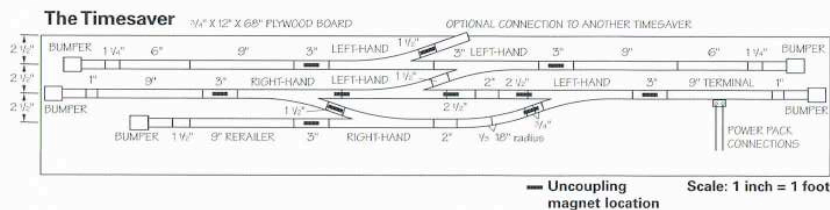

#### Starting car positions

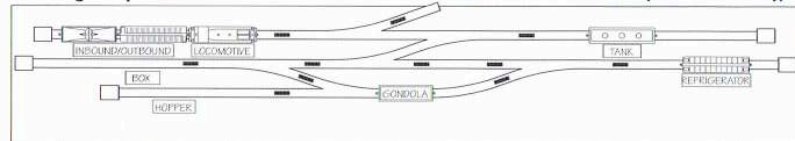

Three cars at labeled destinations.  
Two cars are marked with tags for removal.

#### Finished car positions

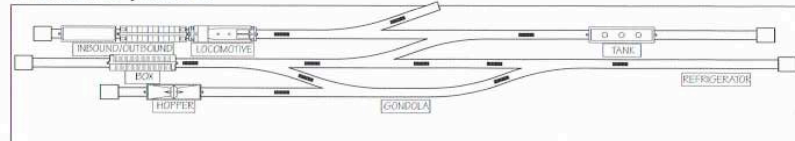

## Resources About Railroading

### Scouting Literature

*Engineering and Model Design and Building merit badge pamphlets*

Visit the Boy Scouts of America's official retail Web site (with your parent's permission) at <http://www.scoutstuff.org> for a complete listing of all merit badge pamphlets and other helpful Scouting materials and supplies.

Herring, Peter. *Ultimate Train*. Dorling Kindersley, 2000.

Hubbard, Freeman. *Encyclopedia of North American Railroading: 150 Years of Railroading in the United States and Canada*. McGraw-Hill Book Company, 1981.

Miller, Allan W., ed. *Model Railroad Resources: A Where-to-Find-It Guide for the Hobbyist*. Krause Publications, 2000.

Schleicher, Robert. *The HO Model Railroading Handbook: Build an Exciting HO Layout the Easy, Inexpensive Way*, 3rd ed. Krause Publications, 1998.

### Books

Ambrose, Stephen E. *Nothing Like It in the World: The Men Who Built the Transcontinental Railroad 1863–1869*. Simon & Schuster, 2000.

Armstrong, John H. *The Railroad: What It Is, What It Does, The Introduction to Railroading*. Simmons-Boardman Books, 1990.

Blumberg, Rhoda. *Full Steam Ahead: The Race to Build a Transcontinental Railroad*. National Geographic Society, 1996.

Drury, George H., and Bob Hayden. *Guide to Tourist Railroads and Railroad Museums 2002*, 37th ed. Kalmbach Publishing Company, 2002.

Solomon, Brian. *The Heritage of North American Steam Railroads: From the First Days of Steam Power to the Present*. Reader's Digest, 2001.

Stover, John F. *The Routledge Historical Atlas of the American Railroads*. Routledge, 1999.

Vantuono, William C. *All About Railroading*. Simmons-Boardman Books, 2001.



**Magazines**

*Model Railroader*  
Kalmbach Publishing Company  
P.O. Box 1612  
Waukesha, WI 53187-1612  
Telephone: 262-796-8776  
Web site: <http://www.trains.com/mrr/>

*Railfan & Railroad*  
Carstens Publications  
108 Phil Hardin Road  
P.O. Box 700  
Newton, NJ 07860  
Telephone: 973-383-3355  
Web site: <http://www.railfan.com>

*Railroad Model Craftsman*  
Carstens Publications  
108 Phil Hardin Road  
P.O. Box 700  
Newton, NJ 07860  
Telephone: 973-383-3355  
Web site: <http://www.rrmodelcraftsman.com>

*Railway Age*  
345 Hudson St.  
New York, NY 10014  
Web site: <http://www.railwayage.com>

*Trains*  
Kalmbach Publishing Company  
P.O. Box 1612  
Waukesha, WI 53187-1612  
Telephone: 262-796-8776  
Web site: <http://www.trains.com/tre/>

**Organizations and Web Sites****Amtrak**

Toll-free telephone: 800-872-7245  
Web site: <http://www.amtrak.com>

**Federal Railroad Administration**

1120 Vermont Ave. NW  
Washington, DC 20590  
Web site: <http://www.fra.dot.gov>

**National Model Railroad Association**

4121 Cromwell Road  
Chattanooga, TN 37421  
Telephone: 423-892-2846  
Web site: <http://www.nmra.org>

**National Railway Historical Society**

100 North 17th St., Suite 1203  
Philadelphia, PA 19103-2783  
Telephone: 215-557-6606  
Web site: <http://www.nrhs.com>

**Operation Lifesaver**

1420 King St., Suite 401  
Alexandria, VA 22314  
Toll-free telephone: 800-537-6224  
Web site: <http://www.oli.org>

**Acknowledgments**

The Boy Scouts of America is grateful to those who helped with the revision of the *Railroading* merit badge pamphlet: Charles A. Anderson and Kathy Anderson, Rail Awareness for Youth (visit <http://www.trainweb.org/nhraa/awareness/index.htm>); Jim Hediger, senior editor of *Model Railroader* magazine, Kalmbach Publishing Company; Peter Hart, staff engineer, Alstom Signaling; William L. Withuhn, senior curator for transportation, National Museum of American History, Smithsonian Institution; the Association of American Railroads, the National Railroad Passenger Corporation (Amtrak), Operation Lifesaver Inc., and the Railroading merit badge staff at the Merit Badge Midway, 2001 National Scout Jamboree.

Special thanks to William C. Vantuono, editor, *Railway Age*, for his close interest and guidance in this new edition of the *Railroading* merit

badge pamphlet. Mr. Vantuono provided technical expertise and many of the photos and illustrations seen in this book. We appreciate his generosity and the time he dedicated to this project.

**Photo and Illustration Credits**

Amtrak, courtesy—page 43

Dallas Area Rapid Transit, courtesy—page 25

©Jupiterimages.com—cover (*all except merit badge*)

Kalmbach Publishing Company, courtesy—pages 18 (*all*), 19 (*center*), 27, 46 (*all*), 54, 56 (*bottom*), 57–58 (*both*), and 60 (*illustration*)

Library of Congress; Brady National Photographic Art Gallery (Washington D.C.), photographer; “Abraham Lincoln, three-quarter length portrait, standing, facing left,” January 8, 1864; Selected Civil War Photographs, 1861–65—page 9 (*inset*)

Library of Congress, Geography and Map Division—page 9 (*map*)

Library of Congress, Prints and Photographs Division; “Peter Cooper’s Tom Thumb”; Bureau of Public Roads, Department of Commerce, between 1900 and 1950—page 7

National Archives and Records Administration—page 10

Norfolk Southern, courtesy—page 34

©Photos.com—pages 6, 12, 35 (*both*), 36, 39–40 (*both*), and 44

Dean Sauvola, courtesy—page 24 (*illustration*)

Trinity Rail, courtesy—pages 17 (*both*) and 19

William C. Vanuono, courtesy—pages 5, 13–14 (*illustrations*), 16 (*center*), 20, 21 (*illustration*), 22, 23 (*illustration*), 33 (*illustration*), 36 (*top illustration*), and 38

All other photos and illustrations not mentioned above are the property of or are protected by the Boy Scouts of America.

Tom Copeland—pages 14 (*top*), 15, 16 (*top, bottom*), 19 (*bottom*), and 41

John McDearmon—illustrations on pages 32, 51–53, and 56–56

Steve Seeger—page 48



## Notes

## MERIT BADGE LIBRARY

Though intended as an aid to Boy Scouts, Varsity Scouts, and qualified Venturers in meeting merit badge requirements, these pamphlets are of general interest and are made available by many schools and public libraries. The latest revision date of each pamphlet might not correspond with the copyright date shown below, because this list is corrected only once a year, in January. Any number of merit badge pamphlets may be revised throughout the year; others are simply reprinted until a revision becomes necessary.

If a Scout has already started working on a merit badge when a new edition for that pamphlet is introduced, he should continue to use the same merit badge pamphlet to earn the badge. He should fulfill the requirements listed in the pamphlet he was using when he began. In other words, the Scout need not start all over again with the new pamphlet and possibly revised requirements.

Merit Badge Pamphlet	Year	Merit Badge Pamphlet	Year	Merit Badge Pamphlet	Year
American Business	2002	Engineering	2000	Photography	2005
American Cultures	2005	Entrepreneurship	2006	Pioneering	2006
American Heritage	2005	Environmental Science	2006	Plant Science	2005
American Labor	2006	Family Life	2005	Plumbing	2004
Animal Science	2006	Farm Mechanics	1997	Pottery	2002
Archaeology	2006	Fingerprinting	2003	Public Health	2005
Archery	2004	Fire Safety	2004	Public Speaking	2002
Architecture	2004	First Aid	2007	Pulp and Paper	2006
Art	2006	Fish and Wildlife		Radio	2001
Astronomy	2004	Management	2004	Railroading	2003
Athletics	2006	Fishing	2002	Reading	2003
Auto Mechanics	2000	Fly-Fishing	2002	Reptile and	
Aviation	2006	Forestry	2005	Amphibian Study	2005
Backpacking	2007	Gardening	2002	Rifle Shooting	2001
Basketry	2003	Genealogy	2005	Rowing	2006
Bird Study	2005	Geology	2005	Safety	2006
Bugling (see Music)		Golf	2002	Salesmanship	2003
Camping	2005	Graphic Arts	2006	Scholarship	2004
Canoeing	2004	Hiking	2007	Sculpture	2007
Chemistry	2004	Home Repairs	2002	Shotgun Shooting	2005
Cinematography	2001	Horsemanship	2004	Skating	2005
Citizenship in the		Indian Lore	2003	Small-Boat Sailing	2004
Community	2005	Insect Study	2002	Snow Sports	2007
Citizenship in the Nation	2005	Journalism	2006	Soil and Water	
Citizenship in the World	2005	Landscape Architecture	2002	Conservation	2004
Climbing	2006	Law	2003	Space Exploration	2004
Coin Collecting	2002	Leatherwork	2002	Sports	2006
Collections	2003	Lifesaving	2001	Stamp Collecting	2007
Communications	2003	Mammal Study	2003	Surveying	2004
Composite Materials	2006	Medicine	2002	Swimming	2002
Computers	2005	Metalwork	2007	Textile	2003
Cooking	2007	Model Design and Building	2003	Theater	2005
Crime Prevention	2005	Motorboating	1992	Traffic Safety	2006
Cycling	2003	Music and Bugling	2003	Truck Transportation	2005
Dentistry	2006	Nature	2003	Veterinary Medicine	2005
Disabilities Awareness	2005	Nuclear Science	2004	Water Sports	2007
Dog Care	2003	Oceanography	2003	Weather	2006
Drafting	1993	Orienteering	2003	Whitewater	2005
Electricity	2004	Painting	2002	Wilderness Survival	2007
Electronics	2004	Personal Fitness	2006	Wood Carving	2006
Emergency Preparedness	2003	Personal Management	2003	Woodwork	2003
Energy	2005	Pets	2005		

## BOY SCOUTS OF AMERICA • SUPPLY DIVISION

### NATIONAL DISTRIBUTION CENTER

2109 Westinghouse Boulevard  
P.O. Box 7143  
Charlotte, NC 28241-7143

[www.scoutstuff.org](http://www.scoutstuff.org)

### DIRECT MAIL CENTER

P.O. Box 909  
Pineville, NC 28134-0909  
For fast credit card orders—  
VISA, MasterCard, American Express—  
call BSA operators toll-free  
1-800-323-0732